



Energy Measuring Module

User's Manual (Details)

MODEL
QE81WH

Thank you for purchasing the Mitsubishi MELSEC-Q series programmable controllers.

Before using this product, please read this manual carefully and pay full attention to safety to handle the product correctly.

Mitsubishi
Programmable Controller

MELSEC-Q

MODEL	QE81WH-U-SY-E
MODEL CODE	19H851
IB63563	

● SAFETY PRECAUTIONS ●

(Read these precautions before using this product.)

This manual contains important instructions for MELSEC-Q series QE81WH.

Before using this product, please read this manual and the relevant manuals carefully and pay full attention to safety to handle the product correctly.

The precautions given in this manual are concerned with this product only. For the safety precautions of the programmable controller system, refer to the user's manual of the CPU module used.

In this manual, the safety precautions are classified into two levels: "DANGER" and "CAUTION".



Indicates that incorrect handling may cause hazardous conditions, resulting in death or severe injury.



Indicates that incorrect handling may cause hazardous conditions, resulting in medium or slight personal injury or physical damage.

Under some circumstances, failure to observe the precautions given under “ CAUTION” may lead to serious consequences.

Observe the precautions of both levels because they are important for personal and system safety.

Keep this manual in an accessible place for future reference whenever needed, and make sure it is delivered to the end user.

[Precautions for Operating Environment and Conditions]

Caution

- Do not use this product in the places listed below. Failure to follow the instruction may cause malfunctions or decrease of product-life.
 - Places the Ambient temperature exceeds the range 0 - 55°C.
 - Places the Relative humidity exceeds the range 5 - 95% or condensation is observed.
 - Altitude exceeds 2000 m.
 - Places exposed to rain or water drop.
 - Dust, corrosive gas, saline and oil smoke exist.
 - Vibration and impact exceed the specifications.
 - Installation on excluding the control board

[Design Precautions]

Danger

- Do not write data into “System Area” in the buffer memory of the intelligent function module.
Also, do not output (turn ON) the “use prohibited” signal in the output signal sent from the sequencer CPU to the intelligent function module.
Doing so may cause a malfunction to the sequencer system.

Caution

- Do not install the input signal wire together with the main circuit lines or power cables. Keep a distance of 300 mm or more between them. (Except for the terminal input part) Failure to do so may result in malfunction due to noise.

[Installation Precautions]

Caution

- Any person who is involved in the installation and the wiring of this Sequencer should be fully competent to do the work.
- Use the programmable controller in an environment that meets the general specifications in the User's manual of the CPU module used.
Failure to do so may result in electric shock, fire, malfunction, or damage to or deterioration of the product.
- To mount the module, while pressing the module-mounting lever located in the lower part of the module, fully insert the module fixing projection(s) into the hole(s) in the base unit and press the module until it snaps into place.
Incorrect mounting may cause a malfunction, failure or a fall of the module.
When using the Sequencer in an environment of frequent vibrations, fix the module with a screw.
- Tighten the screws within the specified torque range.
Fixing-Module screw (arranged by user): M3 x 12mm
Tightening torque of the fixing-module screws 0.36 - 0.48 N•m
When the screw tightening is loose, it causes a fall, short-circuit, and a malfunction.
Over-tightening can damage the screws and the module, and it may cause a fall, short-circuit, or a malfunction.
- Shut off the external power supply for the system in all phases before mounting or removing the module. Failure to do so may result in damage to the product.
- Do not touch directly any conductive parts and electronic parts of the module.
Doing so can cause a malfunction or failure of the module.

[Wiring Precautions]

Danger

- For installation and wiring works, make sure that the power source is shut off for all outside phases. If all phases are not turned off, it may cause an electric shock or product damages.

Caution

- FG terminal must be grounded according to the D-type ground (Type 3) dedicated for sequencer. Failure to do so may result in electric shock or malfunction.
- When using this product, make sure to use it in combination with current sensor (EMU-CT□□□ series or EMU2-CT5).
- Current sensor (EMU-CT50, EMU-CT100, EMU-CT250, EMU-CT400, EMU-CT600) is used only for low voltage circuit. It cannot be used with a high voltage circuit. Also, EMU2-CT5 should be used with the secondary side (5 A) of transformer transfixed. In case directly using for the circuit, only the circuit up to 200V can be used. If it is connected with a high-voltage circuit by mistake, it may cause a burnout of the device and a fire. It is critically dangerous. For the Allowable maximum voltage, refer to Appendix 2 “Option devices”.
- Current sensor has a polarity (directionality). Be careful about it when installing the module.
- Do not open the secondary side of current sensor.
- Take care not entering any foreign objects such as chips and wire pieces into the module. It may cause a fire, failure or a malfunction.
- In order to prevent the module from incoming foreign objects such as wire pieces during wiring work, a foreign-object preventive label is placed on the module. While a wiring work is performed, keep the label on the module. Before operating the system, peel off the label for heat release. If the foreign-object preventive label is not peeled and the system is in use, residual heat inside the module may reduce the product life.
- The wires to be connected to the module shall be put in a duct or fixed together by clamp. If not, the loosening and unstable wire or careless stretching results in poor contact of electric wires. That may cause a breakage of the module or wire or a malfunction.
- Use appropriate size of electric wires. If inappropriate size of electric wire is used, it may cause a fire due to generated heat. For appropriate size of electric wires, refer to 7.4.2 How to connect wires (P7-6).
- In case using stranded wire, take measures so that the filament should not vary by using a bar terminal or by processing the point twisted. Use the bar terminal appropriated for the size of electric wires. If using inappropriate bar terminals, a wire breakage or a contact failure may cause a device malfunction, failure, a burnout or a fire.
- After wiring, confirm whether there is a wiring forgetting or a faulty wiring. They may cause a device malfunction, a fire, or an electric shock.
- When removing the wires connected to the module, do not pull wires as holding on their electric wire portions. Push the buttons on the terminal, and then remove the wire.
- If the wires connected to the module are strongly pulled off, it may cause a malfunction or a breakage to the module or the wire. (Tensile load: 22N or less)
- Ensure the wiring to the module properly, checking the rated voltage and current of the product and the terminal pin assignment. If the input voltage exceed the rated voltage or the wiring is improper, it may cause a fire or a breakage.
- Do not exceed the specified voltage when doing an insulation resistance test and a commercial frequency withstand voltage test.

[Start-up Precautions]

Caution

- Use the product within the ratings specified in this manual. When using it outside the ratings, it not only causes a malfunction or failure but also there is a fear of igniting and damaging by a fire.
- Before operating the product, check that active bare wire and so on does not exist around the product. If any bare wire exists, stop the operation immediately, and take an appropriate action such as isolation protection.
- Do not disassemble or modify the module. It may cause failure, a malfunction, an injury or a fire.
- Attaching and detaching the module must be performed after the power source is shut off for all outside phases. If not all phases are shut off, it may cause failure or a malfunction of the module.
- Do not touch the live terminal. It may cause a malfunction.

[Maintenance Precautions]

Caution

- Cleaning and additional tightening of module-fixing screws must be performed after the input power source is shut off for all outside phases. If not all phases are shut off, it may cause failure or a malfunction of the module.
- Use a soft dry cloth to clean off dirt of the module surface.
- Do not let a chemical cloth remain on the surface for an extended period nor wipe the surface with thinner or benzene.
Check for the following items for using this product properly for long time.
<Daily maintenance>
(1) No damage on this product (2) No abnormality with LED indicators (3) No abnormal noise, smell or heat.
<Periodical maintenance> (Once every 6 months to 1 year)
(4) Confirm there is loosing in installation, wire connection to terminal blocks, and the connection of the connectors. (Check these items under the power failure condition.)

[Storage Precautions]

Caution

- To store this product, turn off the power and remove wires, and put it in a plastic bag.
For long-time storage, avoid the following places. Failure to follow the instruction may cause a failure and reduced life of the product.
 - Places the Ambient temperature exceeds the range -20 to +60°C.
 - Places the Relative humidity exceeds the range 5 - 95% or condensation is observed.
 - Dust, corrosive gas, saline and oil smoke exist, and vibration and frequent physical impact occur.
 - Places exposed to rain or water drop.

[Disposal Precautions]

Caution

- Dispose of the product as an industrial waste.

Revision history

* Instruction Manual Number is provided at the bottom of the cover page.

Printed date	*Instruction Manual #	Description of revisions
Sep, 2010	IB-63563	First edition

This manual does not guarantee to protect or does not give permission to any industrial property and any related rights. Also, our company shall not be held any responsible for any issues related to industrial properties due to product usage described in this manual.

Table of Content

Safety precautions	A-1
Revision history	A-5
Table of content	A-6
Support for EMC directive/ Low voltage directive	A-8
Names and abbreviations	A-8
Product configuration	A-8
<hr/>	
Chapter 1: Overview	1-1
1.1 Features	1-1
<hr/>	
Chapter 2: System Configuration	2-1 - 2-2
2.1 Applicable system	2-1
2.2 Precautions for system configuration	2-2
2.3 How to check the function version, serial number, and module version	2-2
<hr/>	
Chapter 3: Specifications	3-1 - 3-2
3.1 General specifications	3-1
3.2 Electrical and mechanical specifications	3-2
<hr/>	
Chapter 4: Functions	4-1 - 4-17
4.1 List of functions	4-1
4.2 Functions in detail	4-2
4.2.1 Measuring functions	4-2
4.2.2 Measuring function for periodic electric energy	4-9
4.2.3 Max./min. value hold function	4-12
4.2.4 Upper/lower limit alarm monitoring function	4-13
4.2.5 Test function	4-17
<hr/>	
Chapter 5: I/O signal to CPU module	5-1 - 5-6
5.1 List of I/O signals	5-1
5.2 Details of I/O signals	5-2
5.2.1 Input signals	5-2
5.2.2 Output signals	5-5
<hr/>	
Chapter 6: Buffer memory	6-1 - 6-26
6.1 Buffer memory assignment	6-1
6.2 Configurable sections (Un¥G0 to Un¥G99)	6-6
6.3 Measurement sections (Un¥G100 to Un¥G2999)	6-12
6.4 Common sections (Un¥3000 to Un¥G4999)	6-26

Chapter 7: Setting and procedure for operation	7-1 - 7-17
7.1 Precautions for handling	7-1
7.2 Procedure for operation	7-2
7.3 Name and function of each part.....	7-3
7.4 Attaching and removing the module	7-5
7.5 Wiring	7-6
7.6 Setting from GX Developer	7-13
Chapter 8: Programming	8-1 - 8-7
8.1 Programming procedure	8-1
8.2 System configuration and usage conditions for sample program	8-2
8.3 Sample programming	8-4
Chapter 9: Troubleshooting	9-1 - 9-5
9.1 List of error codes	9-1
9.2 Troubleshooting.....	9-2
Appendix	Appendix 1 - 3
Appendix 1: External dimensions	Appendix-1
Appendix 2: Optional devices	Appendix-2
Index	Index 1

COMPLIANCE WITH THE EMC AND LOW VOLTAGE DIRECTIVES

(1) For programmable controller system

To configure a system meeting the requirements of the EMC and Low Voltage Directives when incorporating the Mitsubishi programmable controller (EMC and Low Voltage Directives compliant) into other machinery or equipment, refer to Chapter 9 "EMC AND LOW VOLTAGE DIRECTIVES" of the QCPU User's Manual (Hardware Design, Maintenance and Inspection).

The CE mark, indicating compliance with the EMC and Low Voltage Directives, is printed on the rating plate of the programmable controller.

(2) For the product

For the compliance of this product with the EMC and Low Voltage Directives, refer to Section 7.5 Wiring.

(3) CE marking conformity combination module

This module conforms to CE marking standard in a condition to make combination use with following current sensor and cable.

current sensor	EMU-CT50, EMU-CT100, EMU-CT250, EMU-CT400, EMU-CT600	EMU2-CT5
cable or current sensor cable	CE marking cable (twisted pair cable) Single wire: $\phi 1.2\text{mm}$ ($\phi 0.5 - 1.2\text{mm}$) Stranded wire: 1.3mm^2 ($0.5 - 1.3 \text{mm}^2$)	EMU2-CB-Q5A EMU2-T1M, EMU2-T5M EMU2-T10M, EMU2-T1MS EMU2-T5MS, EMU2-T10MS
Max. cable length	50m	11m

Product configuration

The following describes the product configuration.

Model name	Product name	Quantity
QE81WH	Energy Measuring Module	1

Chapter 1: Overview

This manual explains specifications, handling methods, and programming of Energy Measuring Module QE81WH (hereinafter, abbreviated as QE81WH) supporting MELSEC-Q series.

1.1 Features

- (1) This Energy Measuring Module can measure various types of electric quantity. It can measure electric energy, reactive energy, current, voltage, electric power, power factor, and frequency. Both consumption and regeneration of the electric energy can be measured.
- (2) Extensive monitoring functions
In addition to memorizing the maximum and minimum values, two types of alarm monitoring for upper and lower limit can be performed.
- (3) It also can measure the electric energy for a certain period.
It can measure the electric energy for the duration of time for which the output device is on.
This feature enables to acquire the electric energy needed during device operation or energy per tact.

Chapter 2: System Configuration

2.1 Applicable system

The following describes applicable systems.

- (1) Applicable module and the quantity of attachable pieces
 CPU module to which QE81WH can be attached and the number of attachable pieces are shown below.
 Depending on the combination of the attached module and the number of attached pieces, lack of power capacity may occur.
 When attaching the module, please consider the power capacity.
 If the power capacity is insufficient, reconsider the combination of modules to be attached.



Attachable CPU Module			Attachable quantity.	Remarks
CPU Type	CPU Model			
Programmable controller CPU	Basic model QCPU	Q00JCPU	16	
		Q00CPU	24	
		Q01CPU		
	High performance model QCPU	Q02CPU	64	
		Q02HCPU		
		Q06HCPU		
		Q12HCPU		
		Q25HCPU		
	Process CPU	Q02PHCPU	64	
		Q06PHCPU		
		Q12PHCPU		
		Q25PHCPU		
	Redundant CPU	Q12PRHCPU	53	
		Q25PRHCPU		
	Universal model QCPU	Q00UJCPU	16	
		Q00UCPU	24	
		Q01UCPU		
		Q02UCPU	36	
		Q03UDCPU	64	
		Q04UDHCPU		
Q06UDHCPU				
Q10UDHCPU				
Q13UDHCPU				
Q20UDHCPU				
Q26UDHCPU				
Q03UDECPU				
Q04UDEHCPU				
Q06UDEHCPU				
Q10UDEHCPU				
Q13UDEHCPU				
Q20UDEHCPU				
Q26UDEHCPU				

(2) Attachable base unit

QE81WH can be attached to any I/O slot of the basic base unit and expansion base unit (*1) (*2).

*1 In the case of dual CPU, it can be attached only to an expansion base unit. It cannot be attached to the base unit.

*2 It has to be within the range of I/O slots of the CPU module.

(3) Applicable software package

QE81WH supported software packages are as follows:

(a) Software package for sequencer

Product name	Model name	Remarks
GX Developer	SWnD5C-GPPW	MELSEC sequencer programming software “n” in the model name is 4 or larger.

2.2 Precautions for system configuration

(1) When attaching it to an expansion base without a power module

If QE81WH is attached to an expansion base without a power module, refer to the user's manual of the sequencer CPU to be used in order to select the power module and expansion cable.

2.3 How to check the function version, serial number, and module version

(1) How to check the serial number and module version

It can be checked with the serial number label (placed on the right side of QE81WH).

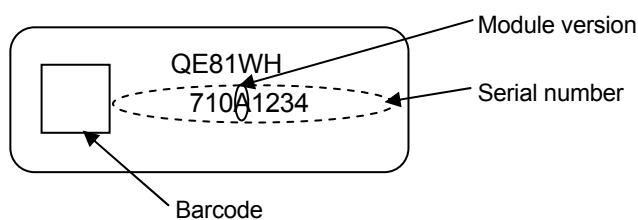

(2) How to check the function version

It can be checked with system monitor (product information list).

To view the system monitor:

Select “Diagnostics” – “System Monitor ...” – Product Inf. List... in GX Developer.

Chapter 3: Specifications

3.1 General specifications

Item		Specifications	
Phase wire system		single-phase 2-wire / single-phase 3-wire / three-phase 3-wire	
Rating	Voltage circuit *1	single-phase 2-wire, three-phase 3-wire	110 V , 220 V AC
		single-phase 3-wire	110V AC (1 - 2 line, 2 - 3 line) 220 V (1 - 3 line)
	Current circuit		50 A, 100 A, 250 A, 400 A, 600 A AC (Current sensor is used. Each value refers to the current at the primary side of current sensor.) 5AAC (Current sensor is used together with current transformer (CT), and the primary-side current is configurable up to 6000 A.) *2
	Frequency		50-60 Hz
Allowable tolerance of main module (excluding current sensor) *3		Current *4 : $\pm 1.0\%$ (100% of the rating) Voltage : $\pm 1.0\%$ (100% of the rating) Electric power : $\pm 1.0\%$ (100% of the rating) Frequency : $\pm 1.0\%$ (45 - 65 Hz range of the rating) Power factor : $\pm 3.0\%$ (against the electric angle 90°) Electric energy : $\pm 2.0\%$ (5 - 100% range of the rating, power factor = 1) Reactive energy : $\pm 2.5\%$ (10 - 100% range of the rating, power factor = 0)	
Measurable circuit count		1 circuit	
Data update cycle		250 ms *5	
Response time		2 seconds or less	
Backup for electric blackout		Backup is made using nonvolatile memory. (Stored items: settings, the max./min. values and time of occurrence, electric energy (consumption, regenerated), reactive energy (consumption lag), and periodic electric energy)	
I/O occupation		16 points (I/O assignment: intelligence 16 points)	

* 1 : 110 V, 220V direct connection is possible. Above 440V voltage transformer outside (VT) is required.

* 2 : 5 A primary current can be set when using the current sensor is as follows.

5A, 6A, 7.5A, 8A, 10A, 12A, 15A, 20A, 25A, 30A, 40A, 50A, 60A, 75A, 80A, 100A, 120A, 150A, 200A, 250A, 300A, 400A, 500A, 600A, 750A , 800A, 1000A, 1200A, 1500A, 1600A, 2000A, 2500A, 3000A, 4000A, 5000A, 6000A

* 3 : Please refer to 2 (1) as for the ratio error of the current sensor.

* 4 : Demand shows the moving average of a set period.

* 5 : Always accumulating the integrated values of Wh and varh. It can capture short-cycled load fluctuation.

3.2 Electrical and mechanical specifications

Item		Specifications					
Consumed VA	Voltage circuit	Each phase 0.1 VA (at 110 V AC), Each phase 0.2 VA (at 220 V AC)					
	Current circuit	Each phase 0.1 VA (secondary side of current sensor)					
Internal current consumption (5 V DC)		0.17 A					
Operating temperature		0 – 55°C (Average daily temperature 35°C or below)					
Operating humidity		5 – 95% RH (No condensation)					
Storage temperature		-25° – +75°C					
Storage humidity		5 – 95% RH (No condensation)					
Operating altitude		2000m or below					
Installation area		Inside a control panel					
Operating environment		No corrosive gas					
Vibration resistance		Conforms to JIS B 3502, IEC 61131-2	Intermittent vibration	Frequency	Constant acceleration	Half amplitude	Sweep time
				5 – 9 Hz	-	3.5 mm	XYZ each direction 10 times
			Continuous vibration	9 – 150 Hz	9.8 m/s ²	-	
				5 – 9 Hz	-	1.75 mm	
Impact resistance		Conforms to JIS B 3502, IEC 61131-2 (147m/s ² , XYZ each direction 3 times)					
Over voltage category * ¹		II or less					
Pollution degree * ²		2 or less					
Equipment category		Class I					
Applicable wire (Usable electric wire)	Voltage input terminal	Single wire	φ1.2 mm (φ0.5 – 1.2 mm)				
		Stranded wire * ⁴	1.3 mm ² (0.5 – 1.3 mm ²)				
	Current input terminal * ³	Single wire	φ1.2 mm (φ0.5 – 1.2 mm)				
		Stranded wire * ⁴	1.3 mm ² (0.5 – 1.3 mm ²)				
Tightening torque		Module-fixing screws (M3 screw) * ⁵	0.36 – 0.48 N·m				
Commercial frequency withstand voltage		Between voltage/current input terminals - FG terminal				2210 V AC 3 sec	
		Between voltage/current input terminals - sequencer power source and GND terminals				2210 V AC 3 sec	
Insulation resistance		5 MΩ or more (500 V DC) at locations above					
Standard		EMC: EN61131-2:2007, EN61326-1:2006 LVD: EN61131-2:2007, EN61010-1:2001					
Dimensions		27.4 mm (W) x 98 mm (H) x 90 mm (D) excluding protruding portions					
Mass		0.1 kg					
Product life expectancy		10 years (used under the average daily temperature 35°C or less)					

*1. This indicates the assumed area of electric distribution to which the device is connected, the area ranging from public distribution to factory machinery. The category II applies to the device power-supplied from fixed facility. The surge voltage of this product is 2500 V up to the rated voltage of 300 V.

*2. The index indicates the level of conductive substance at the device's operating environment. Contamination level 2 means only non-conductive substance. However, occasional condensation may lead to temporary conduction.

*3. At the connection between the secondary terminal of current sensor (k, l) and the main module terminal (1k, 1l, 3k, 3l), use twisted pair cable.

*4. If stranded wire is used, a bar terminal must be used.
Recommended bar terminal: TGV TC-1.25-11T (Made by Nichifu)

*5. The module can be fixed easily to the base unit, using the hook on top of the module. However, if it is used under a vibrating environment, we strongly recommend that the module be fixed with screws.

Chapter 4: Functions

4.1 List of functions

Functions of QE81WH are provided in Table 4.1.

The “n” that is used in this and later chapters (for example: Xn0, Yn0, Un≠G0, etc.) refers to the number that appears at the beginning of QE81WH.

Table 4.1 List of Functions

No.	Function	Descriptions	Reference section
1	Measurement	It measures current, current demand, voltage, electric power, electric power demand, power factor, frequency, effective energy (consumption, regeneration), reactive energy (consumption lag), and sequentially stores the records into a buffer memory.	Section 4.2.1
2	Periodic electric energy	The electric energy only for a period of time when a certain output signal is ON will be stored in the buffer memory. Periodic energy 1 and 2 can be measured independently.	Section 4.2.2
3	Hold max./min. values	For current demand, voltage, electric power demand, and power factor, each maximum/minimum values and date/time of occurrence are stored.	Section 4.2.3
4	Upper/lower limit alarm monitoring	Of current demand, voltage, electric power demand, and power factor, you can select two items for which their upper/lower limit can be monitored. If it exceeds the upper limit or goes below the lower limit, the specified input signal is turned on.	Section 4.2.4
5	Test	The intelligent function module switch enables pseudo-storage of the specified value into the buffer memory, even with non-existence of input from voltage and current (sensor). Using this module, you can create a sequence, etc.	Section 4.2.5

4.2 Functions in detail

4.2.1 Measuring functions

(1) Measured items

Measured items and measured ranges are described as follows:

Each measured item is stored in the buffer memory every 250 ms.

Measured items	
	Details
Current	1 - phase current
	2 - phase current ^{*1}
	3 - phase current ^{*1}
	average current
Current demand * The average of fluctuation for the set period of current demand time is indicated.	1 - phase current demand
	2 - phase current demand ^{*1}
	3 - phase current demand ^{*1}
	Max. value
	Min. value
	Date of max. value occurrence Date of min. value occurrence
Voltage	1 - 2 line voltage
	2 - 3 line voltage ^{*1}
	3 - 1 line voltage ^{*1}
	average voltage
	Max. value
	Min. value
	Date/time of max. value occurrence Date/time of min. value occurrence
Electric power	Present value
Electric power demand * The average of fluctuation for the set period of electric power demand time is indicated.	Present value
	Max. value
	Min. value
	Date/time of max. value occurrence Date/time of min. value occurrence
Power factor	Present value
	Max. value
	Min. value
	Date/time of max. value occurrence Date/time of min. value occurrence
Frequency	Present value
Electric energy	Electric energy (consumption)
	Electric energy (regeneration)
	Reactive energy (consumption lag)
Periodic electric energy ^{*2}	Periodic electric energy 1
	Periodic electric energy 2

*1: If phase wire system is set to single-phase 2-wire, measurement will not be taken.

*2: When the output device is ON, the active power (consumption) is measured.

(2) Total, maximum, and minimum values

The following describes how to calculate the maximum, minimum, and total values.

Item	Phase wire system	Formula
Average current	single-phase 2-wire	Average current = 1-phase current
	single-phase 3-wire three-phase 3-wire	Average current = (1-phase current + 3-phase current) / 2
Average voltage	single-phase 2-wire	Average voltage = voltage between 1 and 2
	single-phase 3-wire three-phase 3-wire	Average voltage = (voltage b/w 1 and 2 + voltage b/w 2 and 3) / 2
Maximum current demand	single-phase 2-wire	Maximum value of 1-phase current demand (The highest value after the max./min. value was reset.)
	single-phase 3-wire	Highest value of either 1-phase current demand or 3-phase current demand (The highest value after the max./min. value was reset.)
	three-phase 3-wire	Highest value among 1-phase current demand, 2-phase current demand, or 3-phase current demand (The highest value after the max./min. value was reset.)
Minimum current demand	single-phase 2-wire	Minimum value of 1-phase current demand (The lowest value after the max./min. value was reset.)
	single-phase 3-wire	Lowest value of either 1-phase current demand or 3-phase current demand (The lowest value after the max./min. value was reset.)
	three-phase 3-wire	Lowest value among 1-phase current demand, 2-phase current demand, or 3-phase current demand (The lowest value after the max./min. value was reset.)
Maximum voltage	single-phase 2-wire	Highest value of the voltage between 1 and 2 wires (The highest value after the max./min. value was reset.)
	single-phase 3-wire	Highest value of either the 1 - 2 line voltage or the 2 - 3 line voltage (The highest value after the max./min. value was reset.)
	three-phase 3-wire	Highest value among the 1 - 2 line voltage, the 2 - 3 line voltage, or 3 - 1 line voltage (The highest value after the max./min. value was reset.)
Minimum voltage	single-phase 2-wire	Lowest value of the voltage between 1 and 2 wires (The lowest value after the max./min. value was reset.)
	single-phase 3-wire	Lowest value of either the 1 - 2 line voltage or the 2 - 3 line voltage (The lowest value after the max./min. value was reset.)
	three-phase 3-wire	Lowest value among the 1 - 2 line voltage, the 2 - 3 line voltage, or 3 - 1 line voltage (The lowest value after the max./min. value was reset.)

(3) Resolution of measured data

Resolution of measured data according to the rating (phase wire system, primary voltage, and primary current) is described as follows.

1) Current, current demand

Rated primary current setting	Multiplier	Resolution*	
5 A to 30 A	-3	2 digits after the decimal point	0.01 A
40 A to 300 A	-3	1 digit after the decimal point	0.1 A
400 A to 3000 A	-3	Integer	1 A
4000 A to 6000 A	-3	×10	10 A

* Digits lower than the resolution are fixed to 0.

2) Voltage

Rated primary voltage setting	Multiplier	Resolution*	
110 V to 220 V	-3	1 digit after the decimal point	0.1 V
440 V to 2200 V	-3	Integer	1 V
3300 V to 6600 V	-3	×10	10 V

* Digits lower than the resolution are fixed to 0.

3) Electric power, electric power demand

Full load power W ^{*1}	Multiplier	Resolution ^{*2}	
I. W < 12 kW	-3	3 digits after the decimal point	0.001 kW
II. 12 kW ≤ W < 120 kW	-3	2 digits after the decimal point	0.01 kW
III. 120 kW ≤ W < 1200 kW	-3	1 digit after the decimal point	0.1 kW
IV. 1200 kW ≤ W < 12000 kW	-3	Integer	1 kW
V. 12000 kW ≤ W < 120000 kW	-3	×10	10 kW

*1 For calculating full load power W, refer to Table 4.2 (pages 4 to 5).

*2 Digits lower than the resolution are fixed to 0.

4) Power factor

Power factor	Multiplier	Resolution*	
All setting ranges	-3	1 digit after the decimal point	0.1%

* Digits lower than the resolution are fixed to 0.

5) Frequency

Frequency	Multiplier	Resolution*	
All setting ranges	-3	1 digit after the decimal point	0.1 Hz

* Digits lower than the resolution are fixed to 0.

6) Electric energy, periodic electric energy

Full load power W^{*1}		Multiplier	Resolution *2		Range [kWh,kvarh]
I.	$W < 12 \text{ kW}$	-5	5 digits after the decimal point	0.00001 kWh, kvarh	0.00001 – 9999.99999
II.	$12\text{kW} \leq W < 120 \text{ kW}$	-4	4 digits after the decimal point	0.0001 kWh, kvarh	0.0001 – 99999.9999
III.	$120\text{kW} \leq W < 1200 \text{ kW}$	-3	3 digits after the decimal point	0.001 kWh, kvarh	0.001 – 999999.999
IV.	$1200\text{kW} \leq W < 12000 \text{ kW}$	-2	2 digits after the decimal point	0.01 kWh, kvarh	0.01 – 9999999.99
V.	$12000\text{kW} \leq W < 120000 \text{ kW}$	-1	1 digit after the decimal point	0.1 kWh, kvarh	0.1 – 99999999.9

*1 For calculating full load power W , refer to Table 4.2 (pages 4-5 to 4-7).

*2 Digits lower than the resolution are fixed to 0.

Table 4.2 How to calculate full load power

(a) single-phase 2-wire method

		Primary voltage [V]								
		110	220	440	690	1100	2200	3300	6600	
Primary current [A]	5									
	6									
	7.5	I	W,var :3 digits after the decimal point Wh,varh :2 digits after the decimal point							
	8									
	10									
	12									
	15									
	20									
	25									
	30									
	40									
	50									
	60									
	75									
	80									
	100									
	120									
	150									
	200									
	250									
300										
400										
500										
600										
750										
800										
1000										
1200										
1500										
1600										
2000										
2500										
3000										
4000										
5000										
6000										

II

W,var :2 digits after the decimal point
Wh,varh :1 digit after the decimal point

III

W,var : 1 digit after the decimal point
Wh,varh : Integer

IV

W,var :Intege
Wh,varh :×10

V

W,var :×10
Wh,varh :×100

(b) single-phase 3-wire method

		Primary voltage [V]
		110
Primary current [A]	5	I
	6	
	7.5	
	8	
	10	
	12	
	15	
	20	
	25	
	30	
	40	
	50	
	60	II
	75	
	80	
	100	
	120	
	150	
	200	III
	250	
	300	
	400	
	500	
	600	
750		
800		
1000		
1200		
1500		
1600	IV	
2000		
2500		
3000		
4000		
5000		
6000		

W,var :3 digits after the decimal point
Wh,varh:2 digits after the decimal point

W,var :2 digits after the decimal point
Wh,varh :1 digit after the decimal point

W,var :1 digit after the decimal point
Wh,varh :Integer

W,var :Integer
Wh,varh :x 10

(c) three-phase 3-wire method

		Primary voltage [V]							
		110	220	440	690	1100	2200	3300	6600
Primary current [A]	5	I							
	6								
	7.5								
	8								
	10								
	12	W,var :3 digits after the decimal point Wh,varh :2 digits after the decimal point							
	15								
	20	II							
	25								
	30								
	40								
	50								
	60	W,var :2 digits after the decimal point Wh,varh :1 digit after the decimal point							
	75								
	80	III							
	100								
	120								
	150								
	200								
	250	W,var :1 digit after the decimal point Wh,varh :Integer							
	300								
	400	IV							
	500								
	600								
750									
800									
1000	W,var :Integer Wh,varh :x 10								
1200									
1500	V								
1600									
2000									
2500									
3000									
4000	W,var :x10 Wh,varh :x100								
5000									
6000									

(4) Restrictions for measuring data

- Measurement cannot be performed immediately after the power loading to the sequencer system (Module ready signal is under the OFF condition).
After checking that Module ready (Xn0) is ON, obtain measuring data.
- Measurement cannot be performed immediately after operating conditions are set up to the module. After checking that Operating condition setting completion flag (Xn9) becomes ON, obtain measuring data.
- Behaviors during operation are as follows:

Measuring item	Behavior of the module
Current	When the input current is less than 0.4% of the rating current, it becomes 0A.
Current demand	Current demand is obtained by current moving average. Therefore, even if current is 0A, current demand may not be 0A.
Voltage	When the input voltage is less than 10% of the rating voltage, it becomes 0V.
Electric power	When current is 0A (at all phases are 0A) or when voltage is 0V (all in-between wires are 0V), it becomes 0kW.
Electric power demand	Electric power demand is obtained by electric power moving average. Therefore, even if electric power is 0kW, electric power demand may not be 0kW.
Power factor	When current is 0A (at all phases are 0A) or when voltage is 0V (all in-between wires are 0V), it becomes 100%.
Frequency	Voltage condition When the input voltage is less than 10% of the rating voltage, it becomes 0Hz.
	Frequency condition When it is less than 44.5Hz, it is fixed to 44.5Hz.

4.2.2 Measuring function for periodic electric energy

This function is to measure electric energy for a certain period, and stores it into the buffer memory. It can be used to measure electric energy for a certain fact or energy (standby power) when the facility or equipment is not in operation.

(1) Overview

- 1) It can measure two periodic electric energy (periodic electric energy 1, periodic electric energy 2). Each of these can be measured independently.
- 2) During the time when Periodic electric energy 1 measurement flag (Yn1)/ Periodic electric energy 2 measurement flag (Yn2) is ON, periodic electric energy can be measured.
- 3) Periodic electric energy is stored in the nonvolatile memory, so that it can be retained even at a power source reset.
- 4) I/O signals and buffer memory corresponding to each periodic electric energy 1 and 2 are provided below.

	Buffer memory (Double words)	Periodic electric energy measurement flag	Periodic electric energy data completion flag	Periodic electric energy reset request	Periodic electric energy reset completion flag
Periodic electric energy 1	Un¥G114, 115	Yn1	Xn1	Yn3	Xn3
Periodic electric energy 2	Un¥G116, 117	Yn2	Xn2	Yn4	Xn4

Note

Measurement of periodic electric energy is performed every measuring cycle (250 ms). Therefore, if the time to turn ON Periodic electric energy 1 measurement flag (Yn1) and Periodic electric energy 2 measurement flag (Yn2) is set to 250 ms or less, measurement may not be taken.

(2) Basic procedure

1) Measuring periodic electric energy

- (a) Check that Periodic electric energy measurement flag (Yn1/Yn2) is OFF.
- (b) Check periodic electric energy (Un≠G114, 115/Un≠G116, 117).
- (c) When starting measurement, set Periodic electric energy measurement flag (Yn1/Yn2) to ON.

This module starts measuring specified periodic electric energy, and Periodic electric energy data completion flag (Xn1/Xn2) will be turned OFF.

- (d) When stopping measurement, set Periodic electric energy measurement flag (Yn1/Yn2) to OFF.

This module stops measuring the specified periodic electric energy, and Periodic electric energy data completion flag (Xn1/Xn2) will be turned ON.

- (e) Check that Periodic electric energy data completion flag (Xn1/Xn2) becomes ON, and obtain the value of periodic electric energy.

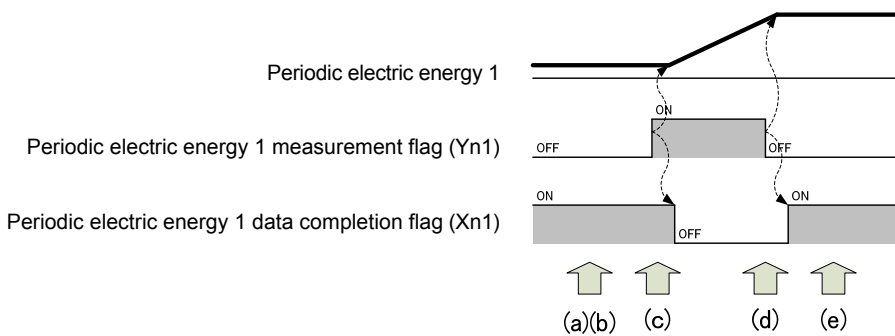

Figure 4.1 Basic procedure of measuring the periodic electric energy

2) Resetting periodic electric power

- (a) Check that Periodic electric energy measurement flag (Yn1/Yn2) is OFF and that Periodic electric energy reset request (Yn3/Yn4) is OFF.

- (b) Set Periodic electric energy reset request (Yn3/Yn4) to ON. The specified periodic electric energy is reset to 0 kWh, and Periodic electric energy reset completion flag (Xn3/Xn4) will be turned to ON.

- (c) Check that Periodic electric energy reset completion flag (Xn3/Xn4) has become ON, and then set Periodic electric energy reset request (Yn3/Yn4) to OFF.

Periodic electric energy reset completion flag (Xn3/Xn4) will be turned OFF.

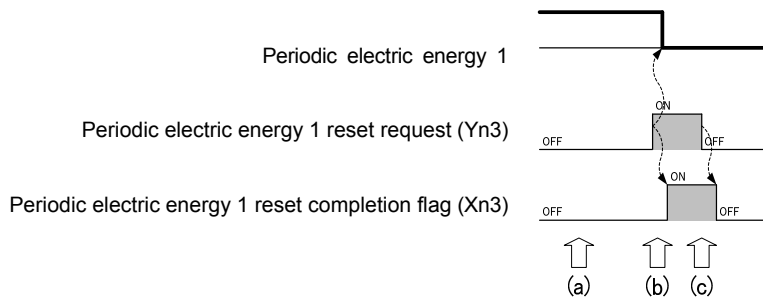

Figure 4.2 How to reset the periodic electric energy

(3) Sample use case

1) Procedure for continuously measuring periodic electric energy

If you turn Periodic electric energy measurement flag (Yn1/Yn2) to ON only for the extent of time you want to measure, this module accumulates the power starting at the previously measured amount. Usage procedure is the same as 1) in (2).

An example is provided below.

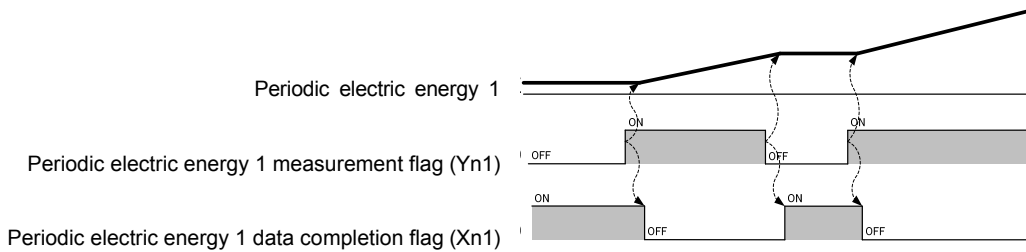

Figure 4.3 Example of continuous measurement of periodic electric energy

2) Procedure for measuring periodic electric energy after every reset

If you turn Periodic electric energy measurement flag (Yn1/Yn2) to ON only for the extent of time you want to measure, this module accumulates the power starting at the previously measured amount. The following describes the usage procedure.

- (a) Check that Periodic electric energy measurement flag (Yn1/Yn2) is OFF and that Periodic electric energy reset request (Yn3/Yn4) is OFF.
- (b) Set Periodic electric energy reset request (Yn3/Yn4) to ON.
The specified periodic electric energy is reset to 0 kWh, and Periodic electric energy reset completion flag (Xn3/Xn4) will be turned ON.
- (c) Check that Periodic electric energy reset completion flag (Xn3/Xn4) has become ON, and then set Periodic electric energy reset request (Yn3/Yn4) to OFF.
Periodic electric energy reset completion flag (Xn3/Xn4) will be turned OFF.
- (d) When starting measurement, set Periodic electric energy measurement flag (Yn1/Yn2) to ON.
This module starts measuring the specified periodic electric energy, and Periodic electric energy data completion flag (Xn1/Xn2) will be turned OFF.
- (e) When stopping measurement, set Periodic electric energy measurement flag (Yn1/Yn2) to OFF.
This module stops measuring the specified periodic electric energy, and Periodic electric energy data completion flag (Xn1/Xn2) will be turned ON.
- (f) Check that Periodic electric energy data completion flag (Xn1/Xn2) becomes ON, and obtain the value of periodic electric energy.

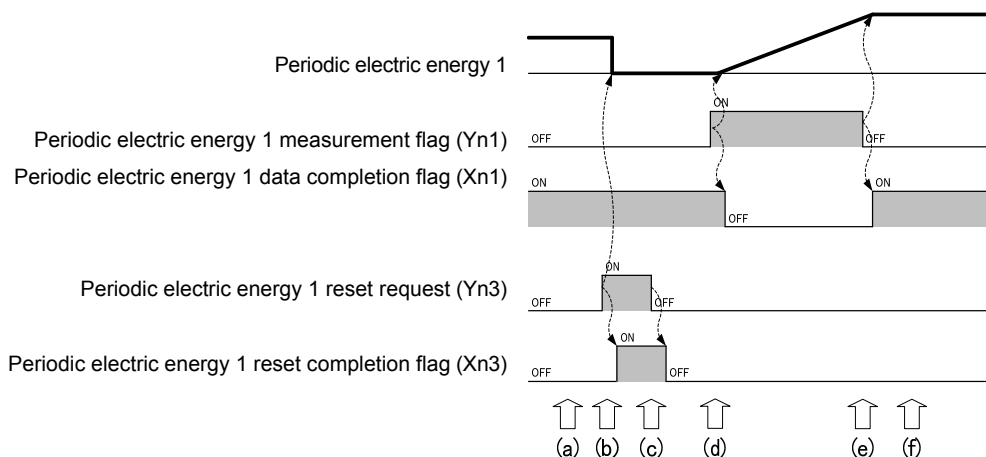

Figure 4.4 Example of measurement of periodic electric energy after every reset

4.2.3 Max./min. value hold function

It memorizes the max./min. value for each measured item, and retains it until the max./min. value clear is performed.

(1) Max./min. value memory

1) It memorizes the max. and min. values for the following measured item.

- Current demand
- Voltage
- Electric power demand
- Power factor

2) It memorizes the date and time of occurrence (year/month/day/hour/minute/second/day of the week) together with the max. and min. values.

3) The max. and min. values and the date of occurrence are stored in the nonvolatile memory, so that these values can be retained even at a power source reset.

(2) How to clear the max. and min. values

1) You can use the I/O signal to clear the max. and min. values.

2) The max. and min. values immediately after the clear will be the present values and the date of occurrence will be the present date and time.

3) The following describes how to clear the max. and min. values.

(a) Check that Max./min. values clear request (YnD) is OFF.

(b) Set Max./min. values clear request (YnD) to ON.

This module clears all the max./min. values and the date of occurrence, and changes Max./min. values clear completion flag (XnD) to ON.

(c) Check that Max./min. values clear completion flag (XnD) is ON, and then set Max./min. values clear request (YnD) to OFF. Max./min. values clear completion flag (XnD) will be turned OFF.



Figure 4.5 Procedure for clearing max./min. value

4.2.4 Upper/lower limit alarm monitoring function

You can set an upper and lower limit alarm for maximum two points and implement a monitoring function for them. During the alarm monitoring, it can monitor the input signal to check for the occurrence.

(1) Setting the upper/lower limit alarm monitoring

1) Setting items and setting range for the alarm monitoring are described below.

Items set in the buffer memory	Setting range	Description
Alarm item (Un¥G11/Un¥G21)	0: No monitoring 1: Current demand upper limit 2: Current demand lower limit 3: Voltage upper limit 4: Voltage lower limit 5: Power demand upper limit 6: Power demand lower limit 7: Power factor upper limit 8: Power factor lower limit	For respective alarm 1 and alarm 2, set the measuring item and either upper or lower limit for monitoring target.
Alarm value (Un¥G12, 13 /Un¥G22, 23)	-2147483648 – 2147483647 [Unit] Current: $\times 10^{-3}$ A Voltage: $\times 10^{-3}$ V Power: $\times 10^{-3}$ kW PF: $\times 10^{-3}\%$	The value to be monitored for the alarm. Set the value according to the unit of the measuring item that is set as an alarm monitoring item. (Double words)
Alarm reset method (Un¥G14/Un¥G24)	0: Self-retention 1: Auto reset	Set whether or not the alarm-occurrence condition should be retained if the value goes below the upper limit alarm value or goes over the lower limit alarm value after the upper/lower limit alarm occurred.
Alarm delay time (Un¥G15/Un¥G25)	0 – 300 [Unit] second	If it exceeds the upper limit alarm value or if it goes below the lower limit alarm value, and the situation continues for the period of the alarm delay time, then it is considered as an alarm occurrence.

2) Setting procedures are as follows:

- (a) Check that Operating condition setting request (Yn9) is OFF.
- (b) Set the alarm item in the buffer memory (Un¥G11/Un¥G21), alarm value (Un¥G12, 13 /Un¥G22, 23), alarm reset method (Un¥G14/Un¥G24), and alarm delay time (Un¥G15/Un¥G25). For the address of buffer memory corresponding the alarm1 and alarm2, refer to Chapter 6.
- (c) Set Operating condition setting request (Yn9) to ON. Operation starts at each set value, and then, Operating condition setting completion flag (Xn9) is turned ON.
- (d) Check that Operating condition setting completion flag (Xn9) becomes ON, and then set Operating condition setting request (Yn9) to OFF. Operating condition setting completion flag (Xn9) will be turned OFF.

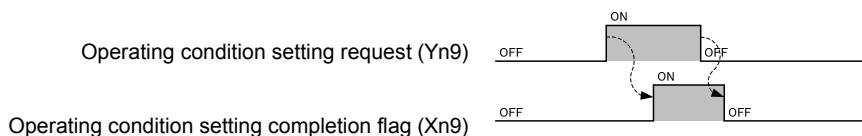

Figure 4.6 Time chart of alarm monitoring setting

3) Each item of the alarm monitoring is stored in the nonvolatile memory, so that values can be retained even at a power source reset.

(2) Behavior of the upper/lower limit alarm

- 1) When the alarm reset method is in the “self-retention” setting (example of an upper limit monitoring at alarm 1)
 - (a) If the measured value that was set with the alarm 1 monitoring item exceeds the upper limit and the situation continues and remains for the alarm 1 delay time, Alarm 1 flag (XnA) will turn ON. At the same time, ALM1 LED flashes.
 - (b) Even if the measured value goes below the upper limit, Alarm 1 flag (XnA) retains an ON status (self retention). During the self-retention, ALM1 LED is turned on.
 - (c) By turning Alarm 1 reset request (YnA) to ON, Alarm 1 flag (XnA) will turn OFF. At this time, ALM1 LED is turned off.
 - (d) Check that Alarm 1 flag (XnA) becomes OFF, and then set Alarm 1 reset request (YnA) to OFF.

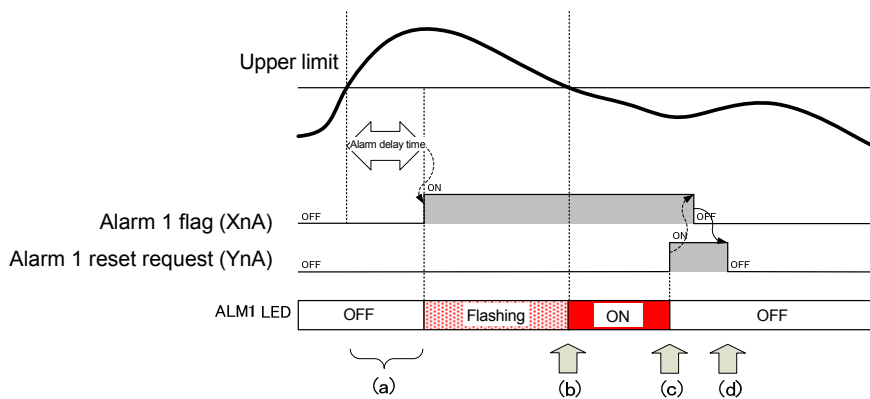

Figure 4.7 Time chart of the upper/lower limit alarm (alarm reset method = “self-retention”)

- 2) When the alarm reset method is in the “auto reset” setting (example of an upper limit monitoring at alarm 1)
 - (a) If the measured value that was set with the alarm 1 item exceeds the upper limit and the situation continues and remains for the alarm 1 delay time, Alarm 1 flag (XnA) will turn ON. At the same time, ALM1 LED flashes.
 - (b) If the measured value goes below the upper limit, Alarm 1 flag (XnA) will turn OFF. At this time, ALM1 LED is turned off.
 - (c) If the measured value that was set with the alarm 1 monitoring item exceeds the upper limit but goes below the upper limit within the alarm 1 delay time, then Alarm 1 flag (XnA) will remain in the OFF status.

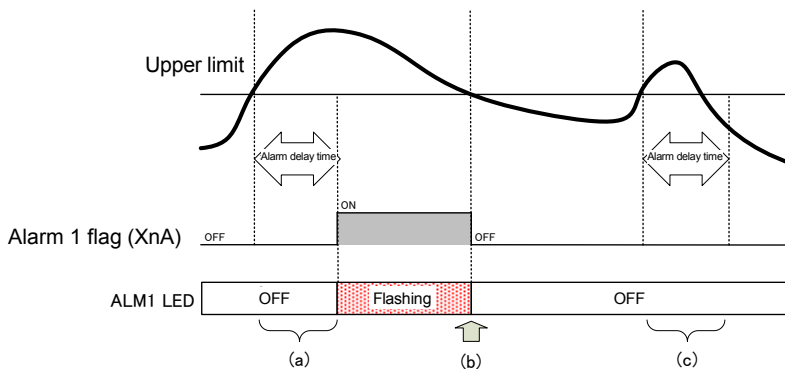

Figure 4.8 Time chart of the upper/lower limit alarm (alarm reset method = “auto-reset”)

3) An example of the alarm 1 was indicated in 1) and 2) above. The alarm 2 will be in accordance with the same behavior.

For the setting items for the buffer memory that corresponds to the alarm 2 and the I/O signals, refer to Chapters 5 and 6. The following describes a case with the alarm 2.

[When the alarm reset method is in the “auto reset” setting (Example of a lower limit monitoring at alarm 2)]

- (a) If the measured value that was set with the alarm 2 item goes below the lower limit and the situation continues and remains for the alarm 2 delay time, Alarm 2 flag (XnB) will turn ON. At the same time, ALM2 LED flashes.
- (b) If the measured value exceeds the lower limit, Alarm 2 flag (XnB) will turn OFF. At this time, ALM2 LED is turned off.
- (c) If the measured value that was set with the alarm 2 monitoring item goes below the lower limit but exceeds the lower limit within the alarm 2 delay time, then Alarm 2 flag (XnB) will remain in the OFF status.

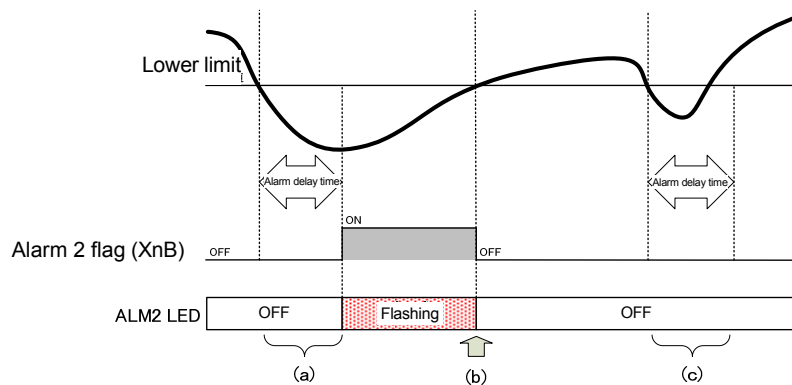

Figure 4.9 Time chart of the upper/lower limit alarm (alarm reset method = “auto-reset”)

(3) How to reset Alarm flag

1) When Alarm flag is ON during the alarm occurrence or the self-retention (in the case of the alarm reset method = "self-retention"), Alarm flag can be reset (turned OFF) using Alarm reset request.

2) How to reset Alarm flag during alarm occurrence (example of the upper limit alarm monitoring with the alarm 1)

- (a) If the measured value that was set with the alarm 1 item exceeds the upper limit, Alarm 1 flag (XnA) will turn ON. At the same time, ALM1 LED flashes.
- (b) By turning Alarm 1 reset request (YnA) to ON, Alarm 1 flag (XnA) will turn OFF. At this time, ALM1 LED will remain flashing (because ALM1 LED is synchronized with the alarm status, it will not turn off).
- (c) Check that Alarm 1 flag (XnA) becomes OFF, and then set Alarm 1 reset request (YnA) to OFF.
- (d) If the measured value goes below the upper limit, ALM1 LED will turn off.
- (e) After that, if the measured value exceeds the upper limit, Alarm 1 flag (XnA) will turn ON again. At the same time, ALM1 LED flashes.

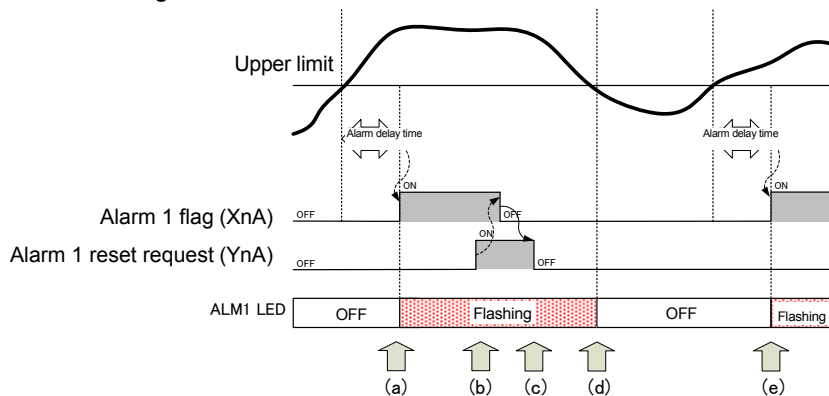

Figure 4.10 Procedure for resetting Alarm 1 flag (alarm reset method = "auto-reset")

3) How to reset Alarm flag during self-retention (in the case the alarm reset method = "self-retention" only)

Refer to the procedure described in (2) 1).

(4) Precautions during the alarm monitoring

1) When current demand time and electric power demand time are set to anytime except 0 second, current demand and electric power demand become lower than the actual values (closer to 0) immediately after the power source ON and the CPU reset. When current demand and electric power demand are being monitored for their lower limit, the alarm occurrence flag may turn ON. Thus, to avoid this from happening, follow the procedure below.

- (a) Set the alarm monitoring target to "no monitoring" immediately after the power source ON and the CPU reset.
- (b) After passing for a 3-times longer period than the demand time, set the alarm monitoring target again, and start the alarm monitoring.

4.2.5 Test function

This function is to output pseudo-fixed value to a buffer memory for debugging sequence program. The value can be output to the buffer memory without input of voltage and current.

(1) How to use the test function

- 1) Using the intelligent function module switch setting, you can start the test mode to output the fixed value.
- 2) For procedure for the intelligent function module switch setting, refer to 7.5.2.
- 3) To finish the test mode, the set value is returned by the intelligent function module switch setting, and after that, it enters to a normal operation by resetting it.
(It resumes with the previous set value, electric energy and periodic electric energy.)

(2) Content of fixed-output

For the value to be output to the buffer memory, refer to Table 6.1 to 6.3 in 6.1 Buffer memory assignment.

(3) Precautions for using the test function

Because fixed-output is output to the buffer memory, isolate the actual device to avoid unexpected operation before running the sequence program.

Chapter 5: I/O signals for the CPU module

5.1 List of I/O signals

I/O signals of QE81WH are listed in Table 5.1.

Table 5.1 List of I/O signals

Input signal (signal direction from QE81WH to CPU module)		Output signal (signal direction from CPU module to QE81WH)	
Device #	Signal name	Device #	Signal name
Xn0	Module ready	Yn0	Use prohibited *1
Xn1	Periodic electric energy 1 data completion flag	Yn1	Periodic electric energy 1 measurement flag
Xn2	Periodic electric energy 2 data completion flag	Yn2	Periodic electric energy 2 measurement flag
Xn3	Periodic electric energy 1 reset completion flag	Yn3	Periodic electric energy 1 reset request
Xn4	Periodic electric energy 2 reset completion flag	Yn4	Periodic electric energy 2 reset request
Xn5	Use prohibited *1	Yn5	Use prohibited *1
Xn6	Use prohibited *1	Yn6	Use prohibited *1
Xn7	Use prohibited *1	Yn7	Use prohibited *1
Xn8	Use prohibited *1	Yn8	Use prohibited *1
Xn9	Operating condition setting completion flag	Yn9	Operating condition setting request
XnA	Alarm 1 flag	YnA	Alarm 1 reset request
XnB	Alarm 2 flag	YnB	Alarm 2 reset request
XnC	Electric energy preset completion flag	YnC	Electric energy preset request
XnD	Max./min. values clear completion flag	YnD	Max./min. values clear request
XnE	Use prohibited *1	YnE	Use prohibited *1
XnF	Error flag	YnF	Error clear request

Point

*1 These signals cannot be used by the user since they are for system use only. If these are set to on or off by the sequence program, the performance of the QE81WH cannot be guaranteed.

5.2 Details of I/O signals

Detailed explanation about I/O signals of QE81WH is provided as follows:

5.2.1 Input signals

(1) Module ready (Xn0)

- (a) When the power of CPU module is turned on or the CPU module reset is performed, it will turn ON as soon as the measurement is ready.
- (b) This signal (Xn0) is turned OFF when energy measuring module displays a hardware error, and RUN LED is turned off.

(2) Periodic electric energy 1 data completion flag (Xn1)

- (a) When Periodic electric energy 1 measurement flag (Yn1) is turned OFF and calculation of the periodic electric energy 1 is stopped, then this signal (Xn1) turns ON. While calculating the periodic electric energy 1, this signal (Xn1) turns OFF.
- (b) In order to acquire the data under the condition where the periodic electric energy 1 is checked after the accumulation of the periodic electric energy is stopped, obtain the data while this signal (Xn1) is ON.

*For specific usage procedures, refer to section 4.2.2.

(3) Periodic electric energy 2 data completion flag (Xn2)

The usage procedure is the same as Periodic electric energy 1 data completion flag (Xn1). Refer to (2).

(4) Periodic electric energy 1 reset completion flag (Xn3)

- (a) When Periodic electric energy 1 reset request (Yn3) is turned ON, and the periodic electric energy 1 that is stored in the buffer memory is reset, then this signal (Xn3) turns ON.

*For specific usage procedures, refer to section 4.2.2.

(5) Periodic electric energy 2 reset completion flag (Xn4)

The usage procedure is the same as Periodic electric energy 1 reset completion flag (Xn3). Refer to (4).

(6) Operating condition setting completion flag (Xn9)

(a) When turning Operating condition setting request (Yn9) to ON and changing the following settings, this signal (Xn9) turns ON.

- Phase wire system (Un \neq G0)
- Primary voltage (Un \neq G1)
- Primary current (Un \neq G2)
- Current demand time (Un \neq G3)
- Electric power demand time (Un \neq G4)
- Alarm 1 item (Un \neq G11)
- Alarm 1 value (Un \neq G12, 13)
- Alarm 1 reset method (Un \neq G14)
- Alarm 1 delay time (Un \neq G15)
- Alarm 2 item (Un \neq G21)
- Alarm 2 value (Un \neq G22, 23)
- Alarm 2 reset method (Un \neq G24)
- Alarm 2 delay time (Un \neq G25)

(b) When Operating condition setting request (Yn9) is OFF, this signal (Xn9) turns OFF.

(7) Alarm 1 flag (XnA)

(a) If the measured value of the alarm 1 item (Un \neq G11) exceeds the upper limit (in the case of the lower alarm, it goes under the lower limit), and if the situation continues and passes the alarm 1 delay time (Un \neq G15), then this signal (XnA) turns ON.

(b) Operations after this signal (XnA) is turned ON are different depending on the setting of the alarm 1 reset method (Un \neq G14).

[When the alarm 1 reset method (Un \neq G14) is "auto reset"]

If the measured value of the alarm 1 monitoring target becomes below the upper limit (in the case of lower limit alarm, it exceeds the lower limit), then this signal (XnA) turns OFF.

[When the alarm 1 reset method (Un \neq G14) is "self retention"]

Even if the measured value of the alarm 1 monitoring target becomes below the upper limit (in the case of lower limit alarm, it exceeds the lower limit), this signal (XnA) retains ON. Then, when Alarm 1 reset request (YnA) is turned to ON, this signal (XnA) turns OFF.

(c) When the measured value of the alarm 1 monitoring target is set to "not monitoring", this signal (XnA) turns OFF.

*For the actual behavior of alarm monitoring, refer to 4.2.4.

(8) Alarm 2 flag (XnB)

The usage procedure is the same as Alarm 1 flag (XnA). Refer to (7).

- (9) Electric energy preset completion flag (XnC)
- (a) When Electric energy preset request (YnC) is turned ON, and preset of each integrated value such as electric energy (consumption), electric energy (regeneration), reactive energy (consumption delay) is completed, this signal (XnC) turns ON.
 - (b) When Electric energy preset request (YnC) is turned OFF, this signal (XnC) turns OFF.
- (10) Max./min. values clear completion flag (XnD)
- (a) When Max./min. values clear request (YnD) is turned ON and the data of max./min. value (maximum value, minimum value and their date and time of occurrence) are cleared, this signal (XnD) turns ON.
 - (b) When Max./min. values clear request (YnD) is turned OFF, this signal (XnD) turns OFF.
- (11) Error flag (XnF)
- (a) If an outside-set-value error occurs, and if a hardware error occurs, this signal (XnF) turns ON.
 - (b) The description of the occurred error can be checked with a latest error code (Un≠G3000).
* For description of error codes, refer to section 9.1.
 - (c) If an outside-set-value error occurs, this signal (XnF) is turned OFF by setting a value within the range again.

5.2.2 Output signals

(1) Periodic electric energy 1 measurement flag (Yn1)

- (a) When switching this signal (Yn1) from the ON status to the OFF status, the periodic electric energy 1 is measured, and will be stored into the buffer memory.
- (b) When this signal (Yn1) is turned OFF, Periodic electric energy 1 data completion flag (Xn1) is turns ON at the time that the periodic electric energy 1 is checked for that period, and then the periodic electric energy 1 is retained.
- (c) In order to read the checked data of the periodic electric energy 1, using the sequence program, use Periodic electric energy 1 data completion flag (Xn1) as the interlock condition.

*For specific usage procedures, refer to section 4.2.2.

(2) Periodic electric energy 2 measurement flag (Yn2)

The usage procedure is the same as that of Periodic electric energy 1 measurement flag (Yn1). Refer to (1).

(3) Periodic electric energy 1 reset request (Yn3)

- (a) When this request (Yn3) is turned ON from the OFF status, Periodic electric energy 1 reset completion flag (Xn3) turns ON, and the periodic electric energy 1 that has been stored in the buffer memory is reset.
- (b) Regardless of the status of Periodic electric energy 1 measurement flag (Yn1), either OFF or ON, the periodic electric energy can be reset using this request (Yn3). When Periodic electric energy 1 measurement flag (Yn1) is ON, and the measurement is taking place, the measurement will resume immediately after the reset.
- (c) When this request (Yn3) is set to OFF, Periodic electric energy 1 reset completion flag (Xn3) turns OFF.

*For specific usage procedures, refer to section 4.2.2.

(4) Periodic electric energy 2 reset request (Yn4)

The usage procedure is the same as that of Periodic electric energy 1 reset request (Yn3). Refer to (3).

(5) Operating condition setting request (Yn9)

- (a) When switching this request (Yn9) from the OFF status to the ON status, the following operating conditions will be set.
 - Phase wire system (Un¥G0)
 - Primary voltage (Un¥G1)
 - Primary current (Un¥G2)
 - Current demand time (Un¥G3)
 - Electric power demand time (Un¥G4)
 - Alarm 1 item (Un¥G11)
 - Alarm 1 value (Un¥G12)
 - Alarm 1 reset method (Un¥G14)
 - Alarm 1 delay time (Un¥G15)
 - Alarm 2 item (Un¥G21)
 - Alarm 2 value (Un¥G22)
 - Alarm 2 reset method (Un¥G24)
 - Alarm 2 delay time (Un¥G25)

- (b) When the operating condition setting is completed, Operating condition setting completion flag (Xn9) turns ON.
 - (c) When this request (Yn9) is turned OFF, Operating condition setting completion flag (Xn9) turns OFF.
- (6) Alarm 1 reset request (YnA)
- (a) When Alarm 1 flag (XnA) is reset, this request (YnA) turns ON.
 - (b) When this request (XnA) is switched from the OFF status to the ON status, Alarm 1 flag (XnA) will forcibly be turned OFF regardless of the present alarm occurrence status.
- (7) Alarm 2 reset request (YnB)
- The usage procedure is the same as that of Alarm 1 reset request (YnA). Refer to (6).
- (8) Electric energy preset request (YnC)
- (a) If you want to set the energy (consumption and regeneration) and the reactive energy to an arbitrary value, write Electric energy preset item (Un¥G51) and Electric energy preset value (Un¥G52, 53) into it, and after that, turn this request (YnC) into ON.
 - (b) When switching this request (YnC) from the OFF status to the ON status, setting of the integrated value will be performed. When the integrated value setting is completed, Electric energy preset completion flag (XnC) turns ON.
 - (c) When this request (YnC) is set to OFF, Electric energy preset completion flag (XnC) turns OFF.
- (9) Max./min. values clear request (YnD)
- (a) When the max./min. value data (max./min. value and their date/time of occurrence) is reset, this request (YnD) turns ON.
 - (b) When switching this request (YnD) from the OFF status to the ON status, the max./min. value data will be cleared. When clearing the max./min. data is completed, Max./min. values clear completion flag (XnD) turns ON.
- (10) Error clear request (YnF)
- (a) When switching this request (YnF) from the OFF status to the ON status while an outside-set-value error is present, Error flag (XnF) turns OFF, and the latest error code in the buffer memory (Un¥G3000) will be cleared.
 - (b) At the same time as clearing the error above, the value that was set in the buffer memory below will be replaced with the previously set value, and Electric energy preset item (Un¥G51) and Electric energy preset value (Un¥G52, 53) will be changed to 0.
[Set value to be replaced with the previously set value]
 - Phase wire system (Un¥G0)
 - Primary voltage (Un¥G1)
 - Primary current (Un¥G2)
 - Current demand time (Un¥G3)
 - Electric power demand time (Un¥G4)
 - Alarm 1 item (Un¥G11)
 - Alarm 1 value (Un¥G12, 13)
 - Alarm 1 reset method (Un¥G14)
 - Alarm 1 delay time (Un¥G15)
 - Alarm 2 item (Un¥G21)
 - Alarm 2 value (Un¥G22, 23)
 - Alarm 2 reset method (Un¥G24)
 - Alarm 2 delay time (Un¥G25)
 - (c) While a hardware error is present (error code: 0000H to 0FFFH), it will not be cleared even if this signal (YnF) turns ON.

Chapter 6: Buffer memory

6.1 Buffer memory assignment

The following describes buffer memory assignment.

Point
In the buffer memory, do not write data to the "system area" or area where data writing data from sequence programs is disabled. Doing so may cause malfunction.

(1) Configurable sections (Un#G0 to Un#G99)

Table 6.1 Configurable sections (Un#G0 to Un#G99)

Item	Address (Decimal)	Data Type	Description	Default value	R/W	Back up*1	Output value during the test mode*2
Setting value	0	Pr	Phase wire system	3	R/W	○	3
	1	Pr	Primary voltage	2	R/W	○	2
	2	Pr	Primary current	2	R/W	○	2
	3	Pr	Current demand time	120	R/W	○	120
	4	Pr	Electric power demand time	120	R/W	○	120
	5-10	-	System area	-	-	-	-
	11	Pr	Alarm 1 item	0	R/W	○	5
	12	Pr	Alarm 1 value	0	R/W	○	1000
	13						
	14	Pr	Alarm 1 reset method	0	R/W	○	0
	15	Pr	Alarm 1 delay time	0	R/W	○	5
	16-20	-	System area	-	-	-	-
	21	Pr	Alarm 2 item	0	R/W	○	6
	22	Pr	Alarm 2 value	0	R/W	○	-1000
	23						
	24	Pr	Alarm 2 reset method	0	R/W	○	1
	25	Pr	Alarm 2 delay time	0	R/W	○	300
	26-50	-	System area	-	-	-	-
	51	Pr	Electric energy preset item	0	W	×	0
	52	Pr	Electric energy preset value	0	W	×	0
53							
54-99	-	System area	-	-	-	-	

*1 Even if the power failure is restored, data is held because data is backed up by the nonvolatile memory.

*2 For the procedure for using the test mode, refer to section 4.2.5.

(2) Measurement sections (Un¥G100 to Un¥G2999)

Table 6.2 Measurement sections (Un¥G100 to Un¥G2999) 1/3

Item	Address (Decimal)	Data Type	Description	Default value	R/W	Back up*1	Output value during the test mode*2
Electric energy	100	Md	Multiplier of electric energy	-4	R	×	-4
	101	-	System area	-	-	-	-
	102	Md	Electric energy (consumption)	0	R	○	123456789
	103						
	104	Md	Electric energy (regeneration)	0	R	○	234567890
	105						
	106	Md	Reactive energy (consumption lag)	0	R	○	345678901
	107						
	108-113	-	System area	-	-	-	-
	114	Md	Periodic electric energy 1	0	R	○	789012345
	115						
	116	Md	Periodic electric energy 2	0	R	○	890123456
	117						
	118-199	-	System area	-	-	-	-
Current	200	Md	Multiplier of current	-3	R	×	-3
	201	-	System area	-	-	-	-
	201	Md	1-phase current	0	R	×	10100
	203						
	204	Md	2-phase current	0	R	×	10200
	205						
	206	Md	3-phase current	0	R	×	10300
	207						
	208	-	System area	-	-	-	-
	209	-	System area	-	-	-	-
	210	Md	1-phase current demand	0	R	×	11100
	211						
	212	Md	2-phase current demand	0	R	×	11200
	213						
	214	Md	3-phase current demand	0	R	×	11300
	215						
	216	-	System area	-	-	-	-
	217	-	System area	-	-	-	-
	218	Md	Average current	0	R	×	10400
	219						
	220	Md	Maximum current demand	0	R	○	10500
	221						
	222	Md	Year of time of max. current demand	*3	R	○	2011H
	223	Md	Month and day of time of max. current demand	*3	R	○	0102H
	224	Md	Hour and minute of time of max. current demand	*3	R	○	0304H
	225	Md	Second and day of the week of time of max. current demand	*3	R	○	0501H
	226	Md	Minimum current demand	*3	R	○	10600
	227						
	228	Md	Year of time of min. current demand	*3	R	○	2012H
	229	Md	Month and day of time of min. current demand	*3	R	○	0203H
230	Md	Hour and minute of time of min. current demand	*3	R	○	0405H	
231	Md	Second and day of the week of time of min. current demand	*3	R	○	0602H	
232-299	-	System area	-	-	-	-	

*1 Even if the power failure is restored, data is held because data is backed up by the nonvolatile memory.

*2 For the procedure for using the test mode, refer to section 4.2.5.

*3 The data becomes value at power on.

Table 6.2 Measurement sections (Un¥G100 to Un¥G2999) 2/3

Item	Address (Decimal)	Data Type	Description	Default value	R/W	Back up*1	Output value during the test mode*2
Voltage	300	Md	Multiplier of voltage	-3	R	×	-3
	301	-	System area	-	-	-	-
	302	Md	1 - 2 line voltage	0	R	×	20100
	303						
	304	Md	2 - 3 line voltage	0	R	×	20200
	305						
	306	Md	3 - 1 line voltage	0	R	×	20300
	307						
	308-313	-	System area	-	-	-	-
	314	Md	Average voltage	0	R	×	20400
	315						
	316-317	-	System area	-	-	-	-
	320	Md	Maximum voltage	0	R	○	20500
	321						
	322	Md	Year of time of max. voltage	*3	R	○	2013H
	323	Md	Month and day of time of max. voltage	*3	R	○	0304H
	324	Md	Hour and minute of time of max. voltage	*3	R	○	0506H
	325	Md	Second and day of the week of time of max. voltage	*3	R	○	0703H
	326	Md	Minimum voltage	*3	R	○	20600
	327						
	328	Md	Year of time of min. voltage	*3	R	○	2014H
	329	Md	Month and day of time of min. voltage	*3	R	○	0405H
	330	Md	Hour and minute of time of min. voltage	*3	R	○	0607H
	331	Md	Second and day of the week of time of min. voltage	*3	R	○	0804H
	332-399	-	System area	-	-	-	-
	Electric power	400	Md	Multiplier of electric power	-3	R	×
401		-	System area	-	-	-	-
402		Md	Electric power	0	R	×	30100
403							
404		Md	Electric power demand	0	R	×	30200
405							
406-419		-	System area	-	-	-	-
420		Md	Maximum value of electric power demand	0	R	○	30300
421							
422		Md	Year of time of max. electric power demand	*3	R	○	2015H
423		Md	Month and day of time of max. electric power demand	*3	R	○	0506H
424		Md	Hour and minute of time of max. electric power demand	*3	R	○	0708H
425		Md	Second and day of the week of time of max. electric power demand	*3	R	○	0905H
426		Md	Minimum value of electric power demand	*3	R	○	30400
427							
428		Md	Year of time of min. electric power demand	*3	R	○	2016H
429		Md	Month and day of time of min. electric power demand	*3	R	○	0607H
430		Md	Hour and minute of time of min. electric power demand	*3	R	○	0809H
431		Md	Second and day of the week of time of min. electric power demand	*3	R	○	1005H
432-699		-	System area	-	-	-	-

*1 Even if the power failure is restored, data is held because data is backed up by the nonvolatile memory.

*2 For the procedure for using the test mode, refer to section 4.2.5.

*3 The data becomes value at power on.

Table 6.2 Measurement sections (Un#G100 to Un#G2999) 3/3

Item	Address (Decimal)	Data Type	Description	Default value	R/W	Back up*1	Output value during the test mode*2
Power factor	700	Md	Multiplier of power factor	-3	R	×	-3
	701	-	System area	-	-	-	-
	702	Md	Power factor	0	R	×	50100
	703						
	704-719	-	System area	-	-	-	-
	720	Md	Maximum power factor	0	R	○	50200
	721						
	722	Md	Year of time of max. power factor	*3	R	○	2017H
	723	Md	Month and day of time of max. power factor	*3	R	○	0708H
	724	Md	Hour and minute of time of max. power factor	*3	R	○	0910H
	725	Md	Second and day of the week of time of max. power factor	*3	R	○	1106H
	726	Md	Minimum power factor	*3	R	○	50300
	727						
	728	Md	Year of time of min. power factor	*3	R	○	2018H
	729	Md	Month and day of time of min. power factor	*3	R	○	0809H
	730	Md	Hour and minute of time of min. power factor	*3	R	○	1011H
	731	Md	Second and day of the week of time of min. power factor	*3	R	○	1200H
732-799	-	System area	-	-	-	-	
Frequency	800	Md	Multiplier of frequency	-3	R	×	-3
	801	-	System area	-	-	-	-
	802	Md	Frequency	0	R	×	60100
	803						
	804-2999	-	System area	-	-	-	-

*1 Even if the power failure is restored, data is held because data is backed up by the nonvolatile memory.

*2 For the procedure for using the test mode, refer to section 4.2.5.

*3 The data becomes value at power on.

(3) Common sections (Un#G3000 to Un#G4999)

Table 6.3 Common sections (Un#G3000 to Un#G4999)

Item	Address (Decimal)	Data Type	Description	Default value	R/W	Back up* ¹	Output value during the test mode* ²
Error	3000	-	Latest error code	0	R	○	1
	3001	-	Year of time of error	0	R	○	2019H
	3002	-	Month and day of time of error	0	R	○	0910H
	3003	-	Hour and minute of time of error	0	R	○	1112H
	3004	-	Second and day of the week of time of error	0	R	○	1301H
	3005-4999	-	System area	-	-	-	-

*1 Even if the power failure is restored, data is held because data is backed up by the nonvolatile memory.

*2 For the procedure for using the test mode, refer to section 4.2.5.

6.2 Configurable sections (Un¥G0 to Un¥G99)

6.2.1 Phase wire system (Un¥G0)

Phase wire system for target electric circuits is configured below.

(1) Setting procedure

(a) Set the phase wire in the buffer memory. Setting range is as follows:

Setting value	Description
1	single-phase 2-wire
2	single-phase 3-wire
3	three-phase 3-wire

(b) Turn Operating condition setting request (Yn9) from OFF to ON to enable the setting. (Refer to 5.2.2 (5).)

(2) Default value

It is set to a three-phase 3-wire (3).

6.2.2 Primary voltage (Un¥G1)

Set the primary voltage of the target electric circuit.

(1) Setting procedure

(a) Set the primary voltage in the buffer memory. Setting range is as follows:

Setting value	Description
1	110 V (Direct connection)
2	220 V (Direct connection)
3	220/110 V
4	440/110 V
5	690/110 V
6	1100/110 V
7	2200/110 V
8	3300/110 V
9	6600/110 V

(b) Turn Operating condition setting request (Yn9) from OFF to ON to enable the setting. (Refer to 5.2.2 (5).)

(2) Default value

It is set to 220 V (2).

6.2.3 Primary current (Un¥G2)

Set the primary current of the target electric circuit.

(1) Setting procedure

(a) Set the primary current in the buffer memory. Setting range is as follows:

Setting value	Description	Setting value	Description
1	50 A	517	120/5 A
2	100 A	518	150/5 A
3	250 A	519	200/5 A
4	400 A	520	250/5 A
5	600 A	521	300/5 A
501	5/5 A	522	400/5 A
502	6/5 A	523	500/5 A
503	7.5/5 A	524	600/5 A
504	8/5 A	525	750/5 A
505	10/5 A	526	800/5 A
506	12/5 A	527	1000/5 A
507	15/5 A	528	1200/5 A
508	20/5 A	529	1500/5 A
509	25/5 A	530	1600/5 A
510	30/5 A	531	2000/5 A
511	40/5 A	532	2500/5 A
512	50/5 A	533	3000/5 A
513	60/5 A	534	4000/5 A
514	75/5 A	535	5000/5 A
515	80/5 A	536	6000/5 A
516	100/5 A		

(b) Turn Operating condition setting request (Yn9) from OFF to ON to enable the setting. (Refer to 5.2.2 (5).)

(2) Default value

It is set to 100 A (2).

6.2.4 Current demand time (Un \neq G3)

Set a time duration for which the average fluctuation of current demand is measured from the measured current value.

If current demand time is set short, the response to change of current will be quick; however, the fluctuation range may be too large. Adjust the duration according to the load and purposes.

(1) Setting procedure

(a) Set current demand time in the buffer memory.

- Configurable range: 0 to 1800 (seconds)
- Set the value in seconds.

(b) Turn Operating condition setting request (Yn9) from OFF to ON to enable the setting. (Refer to 5.2.2 (5).)

(2) Default value

It is set to 120 seconds.

6.2.5 Electric power demand time (Un \neq G4)

Set a time duration for which the average fluctuation of electric power demand is measured from the measured power value.

If electric power demand time is set short, the response to change of power will be quick; however, the fluctuation range may be too large. Adjust the duration according to the load and purposes.

(1) Setting procedure

(a) Set electric power demand time in the buffer memory.

- Configurable range: 0 to 1800 (seconds)
- Set the value in seconds.

(b) Turn Operating condition setting request (Yn9) from OFF to ON to enable the setting. (Refer to 5.2.2 (5).)

(2) Default value

It is set to 120 seconds.

6.2.6 Alarm 1 item (Un¥G11), alarm 2 item (Un¥G21)

Set which measuring item will be monitored for the upper/lower limit alarm.
Alarm 1 and 2 operate independently.

(1) Setting procedure

(a) Set the item for alarm 1 and 2 in the buffer memory. Setting range is as follows:

Setting value	Description
0	No monitoring
1	Current demand upper limit
2	Current demand lower limit
3	Voltage upper limit
4	Voltage lower limit
5	Electric power demand upper limit
6	Electric power demand lower limit
7	Power factor upper limit
8	Power factor lower limit

(b) Measuring items for the monitoring target are as follows:

Description	Measuring item of monitoring target		
	single-phase 2-wire	single-phase 3-wire	three-phase 3-wire
Current demand upper limit Current demand lower limit	1-phase current demand	1-phase current demand 3-phase current demand *1	1-phase current demand 2-phase current demand 3-phase current demand *1
Voltage upper limit Voltage lower limit	1 - 2 line voltage	1 - 2 line voltage 2 - 3 line voltage *1	1 - 2 line voltage 2 - 3 line voltage 3 - 1 line voltage *1
Electric power demand upper limit Electric power demand lower limit	Electric power demand		
Power factor upper limit Power factor lower limit	Power factor *2		

*1 When multiple number of measuring items are targeted for monitoring, the alarm judgment condition will be as following.

Upper/lower limits	Alarm judgment conditions	
	Condition for occurrence	Condition for non-occurrence
Current demand upper limit Voltage upper limit	Any one of alarm item exceeds the alarm value.	All alarm item go below the alarm value.
Current demand lower limit Voltage lower limit	Any one of alarm item go below the alarm value	All alarm item exceeds the alarm value

*2 The idea of upper and lower for PF upper /lower limit judgment is shown below.

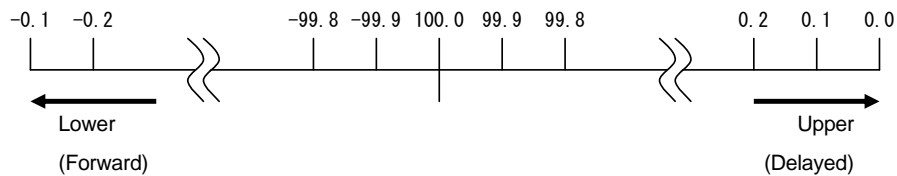

(c) Turn Operating condition setting request (Yn9) from OFF to ON to enable the setting. (Refer to 5.2.2 (5).)

(2) Default value

It is set to not monitoring (0).

6.2.7 Alarm 1 value (Un#G12,13), alarm 2 value (Un#G22, 23)

Set the upper/lower limit monitoring value for the target that was set in alarm 1 item and alarm 2 item.

(1) Setting procedure

(a) Set the monitoring values for alarm 1 and 2 in the buffer memory.

- Configurable range: -2147483648 to 2147483647

- The unit of the setting value is the same as below which was used for the measuring value of the monitored target configured in alarm 1 item and alarm 2 item.

Alarm 1 item Alarm 2 item	Unit of alarm 1 value and alarm 2 value
Current demand upper limit Current demand lower limit	$\times 10^{-3}$ A
Voltage upper limit Voltage lower limit	$\times 10^{-3}$ V
Electric power demand upper limit Electric power demand lower limit	W ($\times 10^{-3}$ kW)
Power factor upper limit Power factor lower limit	$\times 10^{-3}\%$

(b) Turn Operating condition setting request (Yn9) from OFF to ON to enable the setting.

(2) Default value

It is set to 0.

6.2.8 Alarm 1 reset method (Un¶G14), Alarm 2 reset method (Un¶G24)

Set the reset method of the alarm1 and alarm 2.

For differences in behavior of alarm monitoring for different reset methods, refer to 4.2.4 (2).

(1) Setting procedure

(a) Set the reset method for alarm 1 and 2 in the buffer memory. Setting range is as follows:

Setting value	Description
0	Self-retention
1	Auto reset

(b) Turn Operating condition setting request (Yn9) from OFF to ON to enable the setting.

(2) Default value

It is set to self retention (0).

6.2.9 Alarm 1 delay time (Un¶G15), alarm 2 delay time (Un¶G25)

Set the alarm delay time for the alarm 1 and alarm 2.

Alarm delay time means a grace period that takes from the moment when it exceeds the upper limit or goes under the lower limit of the alarm 1 value or alarm 2 value until the alarm flag is turned ON. For detailed behavior, refer to 4.2.4 (2).

(1) Setting procedure

(a) Set the delay time for alarm 1 and alarm 2 in the buffer memory.

- Configurable range: 0 to 300 (seconds)
- Set the value in seconds.

(b) Turn Operating condition setting request (Yn9) from OFF to ON to and enable the setting.

(2) Default value

It is set to 0 seconds.

6.2.10 Set Electric energy preset item (Un¶G51) and Electric energy preset value (Un¶G52, 53)

(1) Setting procedure

(a) Set the integrated value setting target in the buffer memory. Setting range is as follows:

Setting value	Description
0	No set
1	Electric energy (consumption)
2	Electric energy (regeneration)
3	Reactive energy (consumption lag)

(b) Set the integrated value setting value in the buffer memory.

- Configurable range: 0 to 999999999
 - The unit used for the setting value is the same as that used for the electric energy and reactive energy that are output to the buffer memory.
- For details, refer to section 6.3.1.

(c) Turn Electric energy preset request (YnC) from OFF to ON to enable* the setting.

* When the setting is enabled, Electric energy preset completion flag (XnC) changes from OFF to ON.

(2) Default value

It is set to 0.

6.3 Measurement sections (Un¥G100 to Un¥G2999)

6.3.1 Multiplier of electric energy (Un¥G100)

Multiplier of electric energy are stored.

As to how the multiplier is determinate, refer to section 4.2.1 (3).

(1) Details of stored data

(a) Storage format

Data are stored as 16-bit signed binary in the buffer memory.

- Data range: -5 to -1

(b) Update timing

It will be updated when phase wire system (Un¥G0), primary voltage (Un¥G1), and primary current (Un¥G2) are set.

6.3.2 Electric energy (consumption) (Un¥G102,103), electric energy (regeneration) (Un¥G104,105)

Stores the electric energy of the consumption side and the regeneration side will be stored.

(1) Details of stored data

(a) Storage format

Data are stored as double-word 32-bit signed binary in the buffer memory.

- Data range: 0 to 999999999

*For restrictions for measured data including resolution and measuring range, refer to section 4.2.1.

(b) Unit

Unit can be determined by multiplier of electric energy (Un¥G100), as shown below.

Electric energy, multiplier of the reactive energy (Un¥G100)	Unit
-5	$\times 10^{-5}$ kWh
-4	$\times 10^{-4}$ kWh
-3	$\times 10^{-3}$ kWh
-2	$\times 10^{-2}$ kWh
-1	$\times 10^{-1}$ kWh

(c) Update timing

It will be updated every measuring cycle (250 ms).

6.3.3 Reactive energy (consumption lag) (Un¥G106, 107)

Delayed consumption of the reactive energy is stored.

(1) Details of stored data

(a) Storage format

Data are stored as double-word 32-bit signed binary in the buffer memory.

- Data range: 0 to 999999999

*For restrictions for measured data including resolution and measuring range, refer to section 4.2.1.

(b) Unit

Unit can be determined by the electric energy and the multiplier of the reactive energy (Un¥G100), as shown below.

Electric energy, multiplier of the reactive energy (Un¥G100)	Unit
-5	$\times 10^{-5}$ kvarh
-4	$\times 10^{-4}$ kvarh
-3	$\times 10^{-3}$ kvarh
-2	$\times 10^{-2}$ kvarh
-1	$\times 10^{-1}$ kvarh

(c) Update timing

It will be updated every measuring cycle (250 ms).

6.3.4 Periodic electric energy 1 (Un¥G114, 115), periodic electric energy 2 (Un¥G116, 117)

Stores the periodic electric energy 1 and periodic electric energy 2. The periodic electric energy of the consumption side is measured.

For specific usage procedures for the periodic electric energy, refer to section 4.2.2.

(1) Details of stored data

(a) Storage format

Data are stored as double-word 32-bit signed binary in the buffer memory.

- Data range: 0 to 999999999

*For restrictions for measured data including resolution and measuring range, refer to section 4.2.1.

(b) Unit

Unit can be determined by the electric energy and the multiplier of the reactive energy (Un¥G100), as shown below.

Electric energy, multiplier of the reactive energy (Un¥G100)	Unit
-5	$\times 10^{-5}$ kWh
-4	$\times 10^{-4}$ kWh
-3	$\times 10^{-3}$ kWh
-2	$\times 10^{-2}$ kWh
-1	$\times 10^{-1}$ kWh

(c) Update timing

It will be updated every measuring cycle (250 ms).

6.3.5 Multiplier of the electric current (Un#G200)

The multiplier of the electric current is stored.

(1) Details of stored data

(a) Storage format

Data are stored as 16-bit signed binary in the buffer memory.

- Data range: -3 (fixed)

(b) Update timing

Because it is fixed at -3, there is no update.

6.3.6 1-phase current (Un#G202, 203), 2-phase current (Un#G204, 205), 3-phase current (Un#G206, 207)

The electric current (effective value) of each phase is stored.

(1) Details of stored data

(a) Storage format

Data are stored as double-word 32-bit signed binary in the buffer memory.

- Data range: 0 to 99999990 (0 to 99999.990 A)

*For restrictions for measured data including resolution and measuring range, refer to section 4.2.1.

(b) Unit

$\times 10^{-3}$ A *Unit is fixed.

(c) Update timing

It will be updated every measuring cycle (250 ms).

6.3.7 1-phase current demand (Un#G210, 211), 2-phase current demand (Un#G212, 213), 3-phase current demand (Un#G214, 215)

Stores the electric current (effective value) at each phase that is measured based on the moving average for the duration of time configured in the electric current demand time (Un#G3).

(1) Details of stored data

(a) Storage format

Data are stored as double-word 32-bit signed binary in the buffer memory.

- Data range: 0 to 99999990 (0 to 99999.990 A)

*For restrictions for measured data including resolution and measuring range, refer to section 4.2.1.

(b) Unit

$\times 10^{-3}$ A *Unit is fixed.

(c) Update timing

It will be updated every measuring cycle (250 ms).

6.3.8 Average current (Un#G218, 219)

Stores the average current.

For procedure for storing the average current using phase wire system, refer to section 4.2.1 (2).

(1) Details of stored data

(a) Storage format

Data are stored as double-word 32-bit signed binary in the buffer memory.

- Data range: 0 to 99999990 (0 to 99999.990 A)

*For restrictions for measured data including resolution and measuring range, refer to section 4.2.1.

(b) Unit

$\times 10^{-3}$ A *Unit is fixed.

(c) Update timing

It will be updated every measuring cycle (250 ms).

6.3.9 Maximum value of electric current demand (Un#G220,221), minimum value of electric current demand (Un#G226,227)

Stores the max./min. values of the electric current demand among phases.

For procedure for storing the max./min. the electric current demand using phase wire system, refer to section 4.2.1 (2).

(1) Details of stored data

(a) Storage format

Data are stored as double-word 32-bit signed binary in the buffer memory.

- Data range: 0 to 99999990 (0 to 99999.990 A)

*For restrictions for measured data including resolution and measuring range, refer to section 4.2.1.

(b) Unit

$\times 10^{-3}$ A *Unit is fixed.

(c) Update timing

It will be updated every measuring cycle (250 ms) if it exceeds the current max. value or goes under the current min. value.

6.3.10 Year of time of the max. current demand (Un¥G222), month and day of time of the max. current demand (Un¥G223), hour and minute of time of the max. current demand (Un¥G224), second and day of the week of time of the max. current demand (Un¥G225), year of time of the min. current demand (Un¥G228), month and day of time of the min. current demand (Un¥G229), hour and minute of time of the min. current demand (Un¥G230), second and day of the week of time of the min. current demand (Un¥G231)

Stores year, month, day, hour, minute, and the day of the week of time of maximum value of electric current demand (Un¥G220, 221) and minimum value of electric current demand (Un¥G226, 227) were updated.

(1) Details of stored data

(a) Storage format

As indicated below, data are stored as BCD code in the buffer memory.

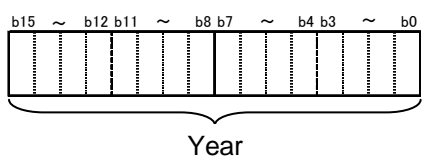
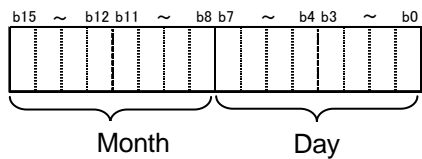
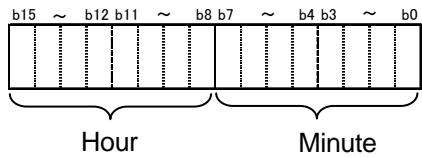
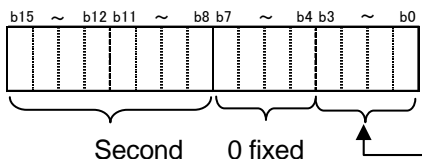
Buffer memory address	Storage format																
Un¥G222 /Un¥G228	 <p>e.g.) Year 2010 2010h</p>																
Un¥G223 /Un¥G229	 <p>e.g.) July 30 0730h</p>																
Un¥G224 /Un¥G230	 <p>e.g.) 10:35 1035h</p>																
Un¥G225 /Un¥G231	 <p>e.g.) 48 sec Friday 4805h</p> <table border="1" data-bbox="1149 1523 1372 1713"> <thead> <tr> <th colspan="2">Day of the week</th> </tr> </thead> <tbody> <tr><td>0</td><td>Sunday</td></tr> <tr><td>1</td><td>Monday</td></tr> <tr><td>2</td><td>Tuesday</td></tr> <tr><td>3</td><td>Wednesday</td></tr> <tr><td>4</td><td>Thursday</td></tr> <tr><td>5</td><td>Friday</td></tr> <tr><td>6</td><td>Saturday</td></tr> </tbody> </table>	Day of the week		0	Sunday	1	Monday	2	Tuesday	3	Wednesday	4	Thursday	5	Friday	6	Saturday
Day of the week																	
0	Sunday																
1	Monday																
2	Tuesday																
3	Wednesday																
4	Thursday																
5	Friday																
6	Saturday																

(b) Update timing

It will be updated every measuring cycle (250 ms) if it exceeds the current max. value or goes under the current min. value.

6.3.11 Multiplier of the electric voltage (Un¥G300)

The multiplier of the electric voltage is stored.

(1) Details of stored data

(a) Storage format

Data are stored as 16-bit signed binary in the buffer memory.

- Data range: -3 (fixed)

(b) Update timing

Because it is fixed at -3, there is no update.

6.3.12 Voltage between 1 and 2 wires (Un¥G302, 303), voltage between 2 and 3 wires (Un¥G304, 305), voltage between 3 and 1 wires (Un¥G306, 307)

The electric voltage between every combination of wires (effective value) is stored.

(1) Details of stored data

(a) Storage format

Data are stored as double-word 32-bit signed binary in the buffer memory.

- Data range: 0 to 99999900 (0 to 99,999.900 V)

*For restrictions for measured data including resolution and measuring range, refer to section 4.2.1.

(b) Unit

$\times 10^{-3}$ V *Unit is fixed.

(c) Update timing

It will be updated every measuring cycle (250 ms).

6.3.13 Average voltage (Un¥G314, 315)

Stores the average voltage.

For procedure for storing the average voltage using phase wire system, refer to 4.2.1 (2).

(1) Details of stored data

(a) Storage format

Data are stored as double-word 32-bit signed binary in the buffer memory.

- Data range: 0 to 99999900 (0 to 99,999.900 V)

*For restrictions for measured data including resolution and measuring range, refer to section 4.2.1.

(b) Unit

$\times 10^{-3}$ V *Unit is fixed.

(c) Update timing

It will be updated every measuring cycle (250 ms).

6.3.14 Maximum voltage (Un¥G320, 321), minimum voltage (Un¥G326, 327)

Stores the max./min. values of the voltage among in-between wires.

For procedure for storing the max./min. voltage using phase wire system, refer to section 4.2.1 (2).

(1) Details of stored data

(a) Storage format

Data are stored as double-word 32-bit signed binary in the buffer memory.

- Data range: 0 to 999999900 (0 to 99,999.900 V)

*For restrictions for measured data including resolution and measuring range, refer to section 4.2.1.

(b) Unit

$\times 10^{-3}$ V *Unit is fixed.

(c) Update timing

It will be updated every measuring cycle (250 ms) if it exceeds the current max. value or goes under the current min. value.

6.3.15 Year of time of the max. voltage (Un¥G322), month and day of time of the max. voltage (Un¥G323), hour and minute of time of the max. voltage (Un¥G324), second and day of the week of time of the max. voltage (Un¥G325), year of time of the min. voltage (Un¥G328), month and day of time of the min. voltage (Un¥G329), hour and minute of time of the min. voltage (Un¥G330), second and day of the week of time of the min. voltage (Un¥G331)

Stores year, month, day, hour, minute, and the day of the week of time of maximum voltage (Un¥G320, 321) and minimum voltage (Un¥G326, 327) were updated.

(1) Details of stored data

(a) Storage format

As indicated below, data are stored as BCD code in the buffer memory.

Buffer memory address	Storage format																
Un¥G322 /Un¥G328	<p>e.g.) Year 2010 2010h</p>																
Un¥G323 /Un¥G329	<p>e.g.) July 30 0730h</p>																
Un¥G324 /Un¥G330	<p>e.g.) 10:35 1035h</p>																
Un¥G325 /Un¥G331	<p>e.g.) 48sec Firday 4805h</p> <table border="1" style="margin-left: 20px;"> <thead> <tr> <th colspan="2">Day of the week</th> </tr> </thead> <tbody> <tr><td>0</td><td>Sunday</td></tr> <tr><td>1</td><td>Monday</td></tr> <tr><td>2</td><td>Tuesday</td></tr> <tr><td>3</td><td>Wednesday</td></tr> <tr><td>4</td><td>Thursday</td></tr> <tr><td>5</td><td>Friday</td></tr> <tr><td>6</td><td>Saturday</td></tr> </tbody> </table>	Day of the week		0	Sunday	1	Monday	2	Tuesday	3	Wednesday	4	Thursday	5	Friday	6	Saturday
Day of the week																	
0	Sunday																
1	Monday																
2	Tuesday																
3	Wednesday																
4	Thursday																
5	Friday																
6	Saturday																

(b) Update timing

It will be updated every measuring cycle (250ms) and if it exceeds the max. value or goes under the min. value.

6.3.16 Multiplier of power (Un¥G400)

The multiplier of power is stored.

(1) Details of stored data

(a) Storage format

Data are stored as 16-bit signed binary in the buffer memory.

- Data range: -3 (fixed)

(b) Update timing

Because it is fixed at -3, there is no update.

6.3.17 Electric power (Un¥G402,403)

The electric power (effective value) is stored.

(1) Details of stored data

(a) Storage format

Data are stored as double-word 32-bit signed binary in the buffer memory.

- Data range: -999999999 to 999999999 (-999999.999 to 999999.999 kW)

*For restrictions for measured data including resolution and measuring range, refer to section 4.2.1.

(b) Unit

$\times 10^{-3}$ kW *Unit is fixed.

(c) Update timing

It will be updated every measuring cycle (250 ms).

6.3.18 Electric power demand (Un¥G404,405)

Stores the electric power that is measured based on the moving average for the duration of time configured in the electric power demand time (Un¥G4).

(1) Details of stored data

(a) Storage format

Data are stored as double-word 32-bit signed binary in the buffer memory.

- Data range: -999999999 to 999999999 (-999999.999 to 999999.999 kW)

*For restrictions for measured data including resolution and measuring range, refer to section 4.2.1.

(b) Unit

$\times 10^{-3}$ kW *Unit is fixed.

(c) Update timing

It will be updated every measuring cycle (250 ms).

6.3.19 Maximum value of electric power demand (Un#G420, 421), minimum value of electric power demand (Un#G426, 427)

Stores the max./min. values of the electric power demand.

(1) Details of stored data

(a) Storage format

Data are stored as double-word 32-bit signed binary in the buffer memory.

- Data range: -999999999 to 999999999 (-999999.999 to 999999.999 kW)

*For restrictions for measured data including resolution and measuring range, refer to section 4.2.1.

(b) unit

$\times 10^{-3}$ kW *Unit is fixed.

(c) Update timing

It will be updated every measuring cycle (250 ms) if it exceeds the current max. value or goes under the current min. value.

6.3.20 Year of time of the max. electric power demand (Un¥G422), month and day of time of the max. electric power demand (Un¥G423), hour and minute of time of the max. electric power demand (Un¥G424), second and day of the week of time of the max. electric power demand (Un¥G425), year of time of the min. electric power demand (Un¥G428), month and day of time of the min. electric power demand (Un¥G429), hour and minute of time of the min. electric power demand (Un¥G430), second and day of the week of time of the min. electric power demand (Un¥G431)

Stores year, month, day, hour, minute, and the day of the week of time of maximum value of electric power demand (Un¥G420, 421) and minimum value of electric power demand (Un¥G426, 427) were updated.

(1) Details of stored data

(a) Storage format

As indicated below, data are stored as BCD code in the buffer memory.

Buffer memory address	Storage format																
Un¥G422 /Un¥G428	<p>e.g.) Year 2010 2010h</p>																
Un¥G423 /Un¥G429	<p>e.g.) July 30 0730h</p>																
Un¥G424 /Un¥G430	<p>e.g.) 10:35 1035h</p>																
Un¥G425 /Un¥G431	<p>e.g.) 48sec Friday 4805h</p> <table border="1" style="margin-left: 20px;"> <thead> <tr> <th colspan="2">Day of the week</th> </tr> </thead> <tbody> <tr><td>0</td><td>Sunday</td></tr> <tr><td>1</td><td>Monday</td></tr> <tr><td>2</td><td>Tuesday</td></tr> <tr><td>3</td><td>Wednesday</td></tr> <tr><td>4</td><td>Thursday</td></tr> <tr><td>5</td><td>Friday</td></tr> <tr><td>6</td><td>Saturday</td></tr> </tbody> </table>	Day of the week		0	Sunday	1	Monday	2	Tuesday	3	Wednesday	4	Thursday	5	Friday	6	Saturday
Day of the week																	
0	Sunday																
1	Monday																
2	Tuesday																
3	Wednesday																
4	Thursday																
5	Friday																
6	Saturday																

(b) Update timing

It will be updated every measuring cycle (250 ms) if it exceeds the current max. value or goes under the current min. value.

6.3.21 Multiplier of power factor (Un#G700)

The multiplier of the power factor is stored.

(1) Details of stored data

(a) Storage format

Data are stored as 16-bit signed binary in the buffer memory.

- Data range: -3 (fixed)

(b) Update timing

Because it is fixed at -3, there is no update.

6.3.22 Power factor (Un#G702, 703)

Stores the power factor.

(1) Details of stored data

(a) Storage format

Data are stored as double-word 32-bit signed binary in the buffer memory.

- Data range:-99900 to 100000 (-99.900 to 100.000%)

*For restrictions for measured data including resolution and measuring range, refer to section 4.2.1.

(b) Unit

$\times 10^{-3}\%$ *Unit is fixed.

(c) Update timing

It will be updated every measuring cycle (250 ms).

6.3.23 Year of time of the max. power factor (Un#G722), month and day of time of the max. power factor (Un#G723), hour and minute of time of the max. power factor (Un#G724), second and day of the week of time of the max. power factor (Un#G725), year of time of the min. power factor (Un#G728), month and day of time of the min. power factor (Un#G729), hour and minute of time of the min. power factor (Un#G730), second and day of the week of time of the min. power factor (Un#G731)

Stores year, month, day, hour, minute, and the day of the week of time of maximum power factor (Un#G720, 721) and minimum power factor (Un#G726, 727) were updated.

(1) Details of stored data

(a) Storage format

As indicated below, data are stored as BCD code in the buffer memory.

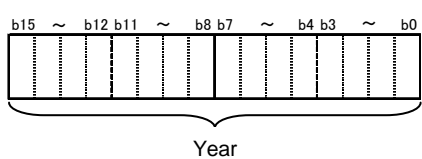
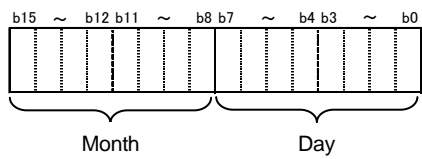
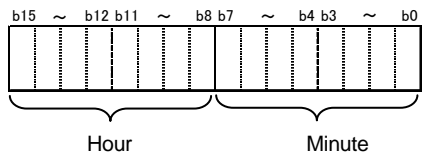
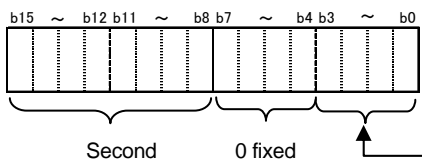
Buffer memory address	Storage format																
Un#G722 /Un#G728	 <p>e.g.) Year 2010 2010h</p>																
Un#G723 /Un#G729	 <p>e.g.) July 30 0730h</p>																
Un#G724 /Un#G730	 <p>e.g.) 10:35 1035h</p>																
Un#G725 /Un#G731	 <p>e.g.) 48sec Friday 4805h</p> <table border="1" data-bbox="1149 1444 1380 1635"> <thead> <tr> <th colspan="2">Day of the week</th> </tr> </thead> <tbody> <tr> <td>0</td> <td>Sunday</td> </tr> <tr> <td>1</td> <td>Monday</td> </tr> <tr> <td>2</td> <td>Tuesday</td> </tr> <tr> <td>3</td> <td>Wednesday</td> </tr> <tr> <td>4</td> <td>Thursday</td> </tr> <tr> <td>5</td> <td>Friday</td> </tr> <tr> <td>6</td> <td>Saturday</td> </tr> </tbody> </table>	Day of the week		0	Sunday	1	Monday	2	Tuesday	3	Wednesday	4	Thursday	5	Friday	6	Saturday
Day of the week																	
0	Sunday																
1	Monday																
2	Tuesday																
3	Wednesday																
4	Thursday																
5	Friday																
6	Saturday																

(b) Update timing

It will be updated every measuring cycle (250 ms) if it exceeds the current max. value or goes under the current min. value.

6.3.24 Multiplier of the frequency (Un#G800)

The multiplier of the frequency is stored.

(1) Details of stored data

(a) Storage format

Data are stored as 16-bit signed binary in the buffer memory.

- Data range: -3 (fixed)

(b) Update timing

Because it is fixed at -3, there is no update.

6.3.25 Frequency (Un#G802, 803)

Stores the frequency.

(1) Details of stored data

(a) Storage format

Data are stored as double-word 32-bit signed binary in the buffer memory.

- Data range: 0 to 999900 (-0 to 999.900 Hz)

*For restrictions for measured data including resolution and measuring range, refer to section 4.2.1.

(b) Unit

$\times 10^{-3}\%$ *Unit is fixed.

(c) Update timing

It will be updated every measuring cycle (250 ms).

6.4 Common sections (Un¥G3000 to Un¥G4999)

6.4.1 Latest error code (Un¥G3000)

The latest error code that is detected with this module will be stored.
 *For the list of error codes, refer to section 9.1.

(1) Details of stored data

(a) Storage format

Data are stored as 16-bit signed binary in the buffer memory.
 - Data range: 0000h (normal), 0001h to FFFFh (error code)

(b) Update timing

It will be updated at the time of error occurrence and error recovery.

6.4.2 Year of time of the error (Un¥G3001), month and day of time of the error (Un¥G3002), hour and minute of the error (Un¥G3003), second and day of the week of time of the error (Un¥G3004)

The year, month, day, hour, minute, and day of the week of time of the error will be stored.

(1) Details of stored data

(a) Storage format

As indicated below, data are stored as BCD code in the buffer memory.

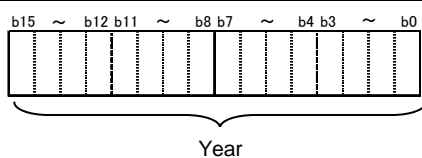
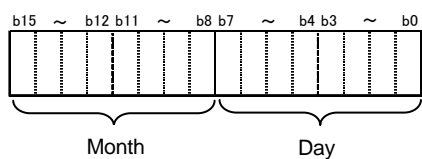
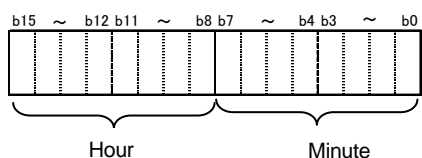
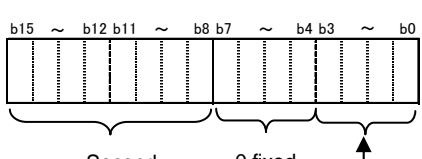
Buffer memory address	Storage format
Un¥G3001	 <p>e.g.) Year 2010 2010h</p>
Un¥G3002	 <p>e.g.) July 30 0730h</p>
Un¥G3003	 <p>e.g.) 10:35 1035h</p>
Un¥G3004	 <p>e.g.) 48sec Friday 4805h</p>

Day of the week	
0	Sunday
1	Monday
2	Tuesday
3	Wednesday
4	Thursday
5	Friday
6	Saturday

(b) Update timing

It will be updated at the time of error occurrence and error recovery.

Chapter 7: Setting and procedure for operation

7.1 Precautions for handling

- (1) Do not drop or apply strong shock to the module case.
- (2) Do not remove the printed-circuit board of the module from the case.
Doing so may cause failure.
- (3) Prevent foreign matter such as dust or wire chips from entering the module.
Such foreign matter can cause a fire, failure, or malfunction.
- (4) A protective film is attached to the top of the module to prevent foreign matter, such as wire chips, from entering the module during wiring.
Do not remove the film during wiring.
Remove it for heat dissipation before system operation.
- (5) Module fixing screws must be tightened within the specified range as described below.
Loose screws may cause short-circuit, failure, or malfunction.
*1 The module can be fixed easily to the base unit, using the hook on top of the module. However, if it is used under a vibrating environment, we strongly recommend that the module be fixed with screws.

Table 7.1 Tightening torque

Locations of screws	Torque range
Module-fixing screws (M3 screw) *1	0.36 - 0.48 N•m

- (6) To attach the module to the base unit, firmly insert the protruding portions for fixing the module into the holes on the base unit, and make sure the module is securely attached to the module holes as fulcrum points.
Insecure attachment of the module may cause malfunction, failure, and a falling.
- (7) Before touching the module, make sure that you need to discharge static electricity on your body by touching a metal that is grounded.
Otherwise, it may cause failure or malfunction to the module.

7.2 Procedure for operation

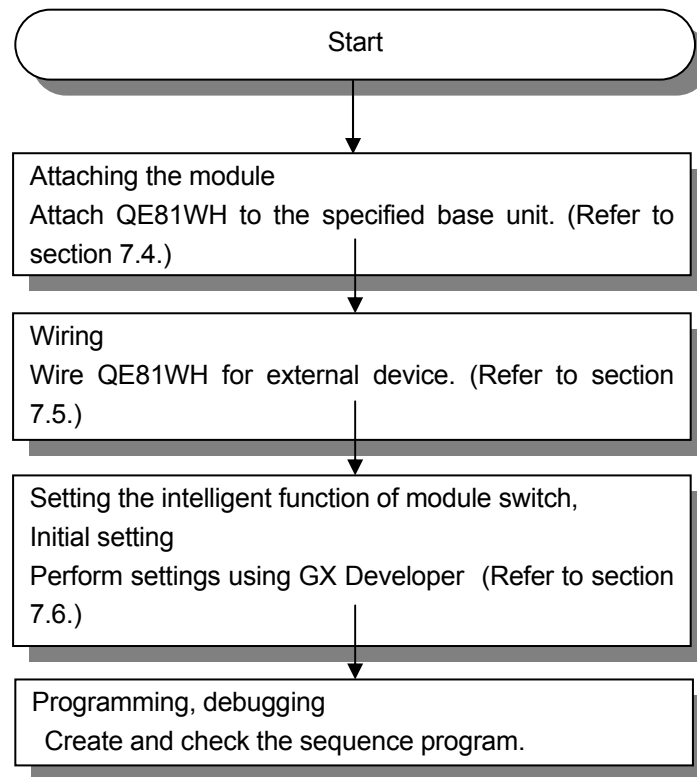

Figure 7.1 Procedure for operation

7.3 Name and function of each part

Names and functions of parts of QE81WH are provided below.

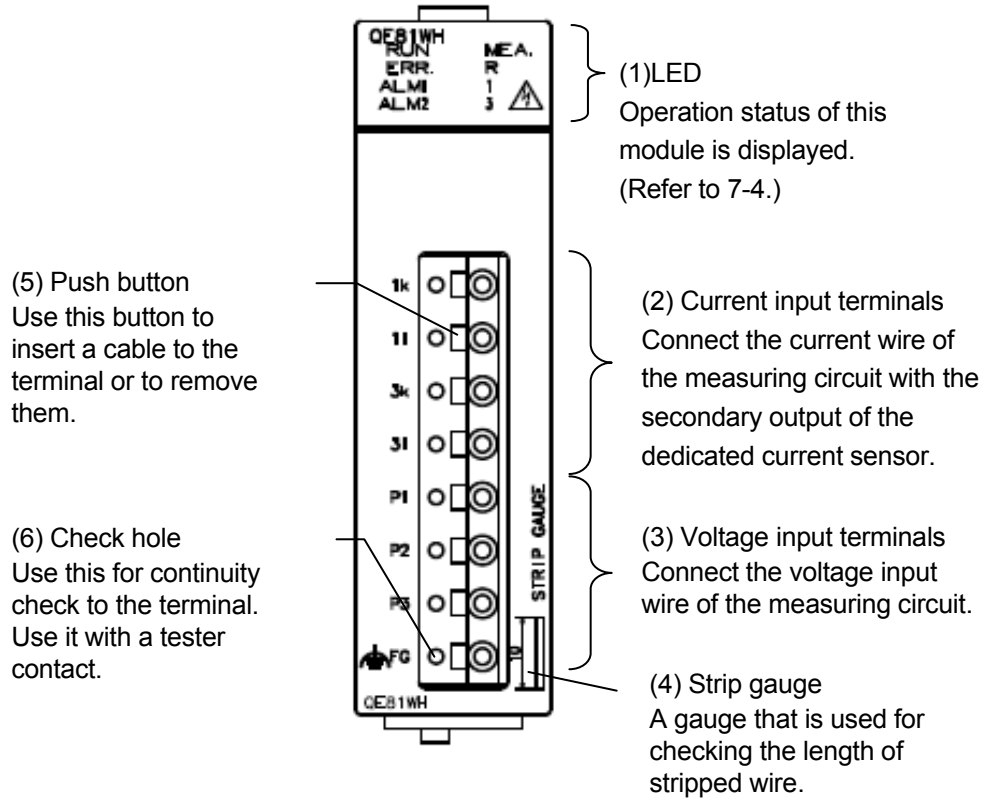

Figure 7.2 Appearance of the module

(1) Names and functions of LEDs

The following describes names and functions of LEDs.

Table 7.2 Names and functions of LEDs

Name	Color	Role	ON/OFF condition
RUN LED	Green	Displays the operation status of this module.	ON: Normal operation OFF: 5V power discontinuity, watch dog timer error
ERR. LED	Red	Displays errors and conditions of this module.	ON: Error occurring (except out-of-range error) ^{*1} Flashing: Out-of-range error ^{*1} OFF: Normal operation
ALM1 LED	Red	Displays alarm 1 occurrence status.	Flashing: Alarm 1 occurring ON: Alarm 1 occurring → Not occurring (In the case of alarm 1 reset method = self-retention) OFF: Alarm 1 not occurring
ALM2 LED	Red	Displays alarm 2 occurrence status.	Flashing: Alarm 2 occurring ON: Alarm 2 occurring → Not occurring (In the case of alarm 2 reset method = self-retention) OFF: Alarm 2 not occurring
MEA. LED	Green	Displays the status of measurement of this module.	ON: Measuring electric energy (consumption) or electric energy (regeneration) OFF: Other than the above
R LED	Green	Displays the status of measurement (regeneration) of this module.	ON: Measuring electric energy (regeneration) OFF: Other than the above
1 LED	Green	Displays the status of measurement (regeneration) at side 1 of this module.	ON: Measuring 1-phase electric energy (regeneration) OFF: Other than the above
3 LED	Green	Displays the status of measurement (regeneration) at side 3 of this module.	ON: Measuring 3-phase electric energy (regeneration) OFF: Other than the above

*1 For details, check with the list of error codes. (Refer to section 9.1)

(2) Names of signals of terminal block

The following describes names of signals of terminal block.

Table 7.3 Names of signals of terminal block

Terminal symbol	Name of terminal
1k	1-phase current input terminal (power source side)
1l	1-phase current input terminal (load side)
3k	3-phase current input terminal (power source side)
3l	3-phase current input terminal (load side)
P1	1-phase voltage input terminal
P2	2-phase voltage input terminal
P3	3-phase voltage input terminal
FG	Frame GND terminal

7.4 Attaching and removing the module

7.4.1 How to attach to the base unit (Q6□WRB)

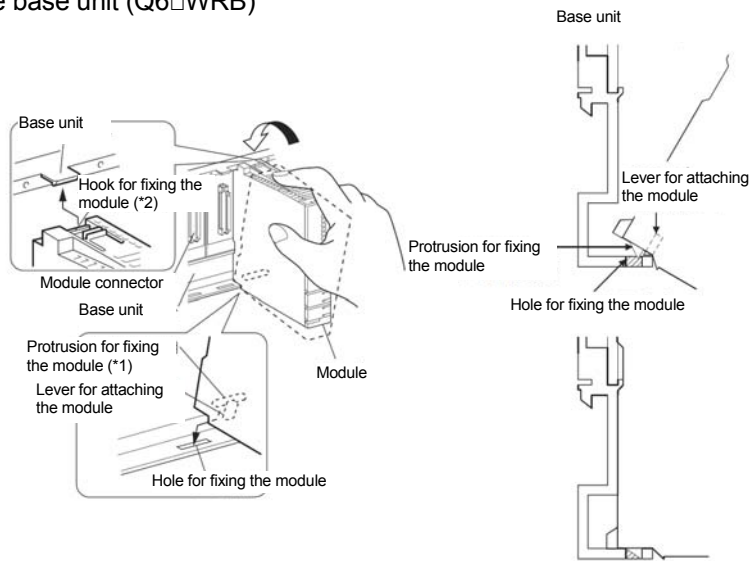
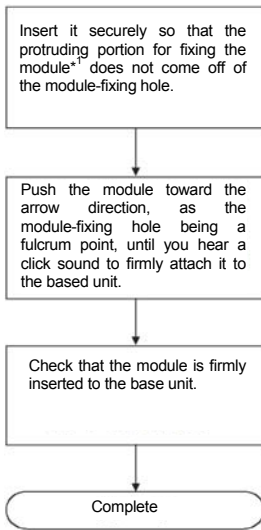

- When attaching the module, make sure to insert the protruding portions for fixing the module into the holes on the base unit. In doing so, insert it securely so that the protruding portion of the module does not come off of the holes. Do not force to attach the module; otherwise the module may break.
- When installing the module at a vibrating area with strong impact, tighten the module to the base unit using screws. Module-fixing screws: M3 x 12mm (Prepare them yourself.)
- Attaching and detaching the module and the base unit should be performed 50 times or less (to conform to JIS B3502). If the count exceeds 50 times, it may cause a malfunction.

7.4.2 How to detach it from the base unit (Q6□WRB)

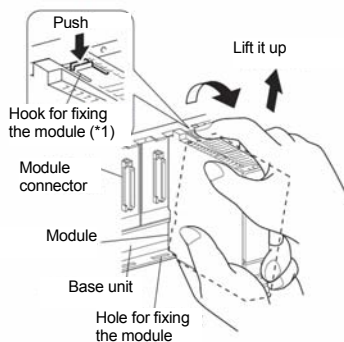
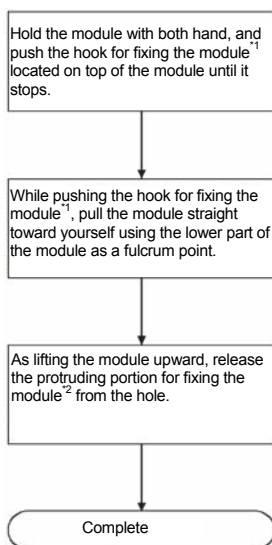

- When module-fixing screws are used, make sure to remove the screws for detaching the module first, and then remove the protruding portion for fixing the module from the holes. Do no force to remove the module; it may break the protruding portions for fixing the module.

7.5 Wiring

7.5.1 Precautions for wiring

- (1) Connect cables. For connecting voltage transformer and current transformer, refer to the corresponding wiring diagram.
- (2) For wiring, check with the wiring diagram and check phase wire system for the connecting circuit.
- (3) For the current circuit input, Mitsubishi's current sensor is required. (Refer to section 7.5.3)
- (4) If a current sensor is located in a strong magnetic field such as an area nearby a transformer or high-current cable bus bar, the voltage circuit input may be influenced, which in turn affects the measured value. Thus, please ensure sufficient distance between devices.
- (5) For input wiring of the measurement circuit, use separate cables from other external signals in order to prevent from AC surge and induction.
- (6) Keep any object off the cables.
- (7) Protect cable coating from scratch.

7.5.2 How to connect wires

- (1) Follow the wiring diagram for external connection to QE81WH.

- (2) Use appropriate electric wires as described below.

At the connection between the secondary terminal of current sensor and current input terminals, use twisted pair cable.

Applicable wire (Usable electric wire)	Single wire: $\phi 1.2\text{mm}$ ($\phi 0.5\text{mm}$ to $\phi 1.2\text{mm}$) Stranded wire: 1.3mm^2 (0.5mm^2 to 1.3mm^2)
---	---

- (3) Stripping length of the used wire in use has to be 10 to 11mm. Check the stripping length using the strip gauge of QE81WH main module.

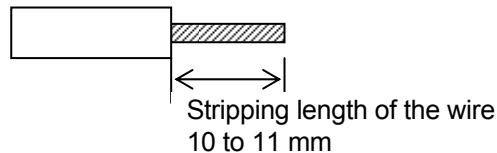

- (4) When stranded wire is used, a bar terminal must be used.

Recommended bar terminal	TGV TC-1.25-11T (Made by Nichifu) or equivalent
--------------------------	---

- (5) When attaching and detaching cables to/from the terminal, use the push button. Check that the wire is securely inserted.
- (6) Insert a wire to the terminal all the way until it touches the end.

7.5.3 How to wire

Follow the wiring diagram (Figure 7.3) for external connection of QE81WH.

Figure 7.3-1 In the case of Three-phase 3-wire method

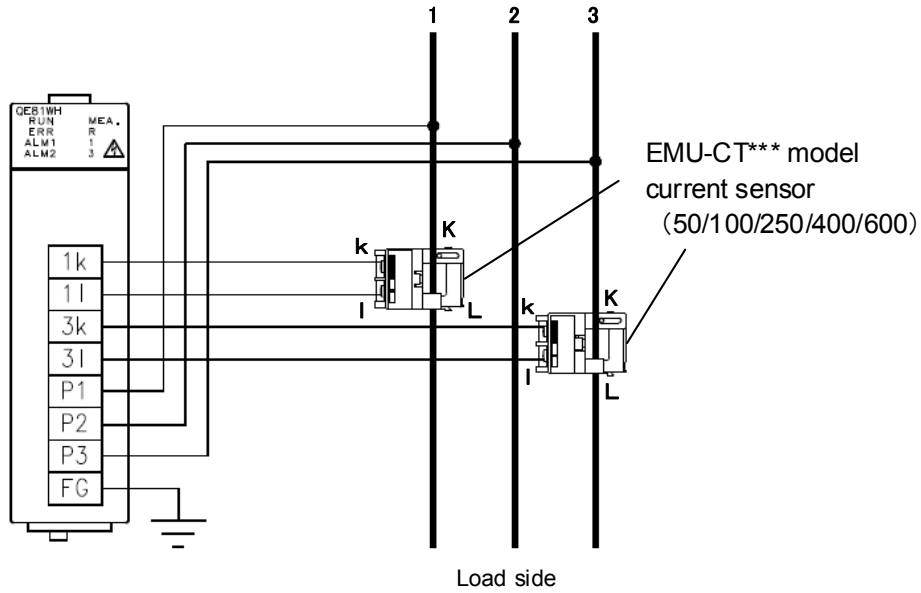
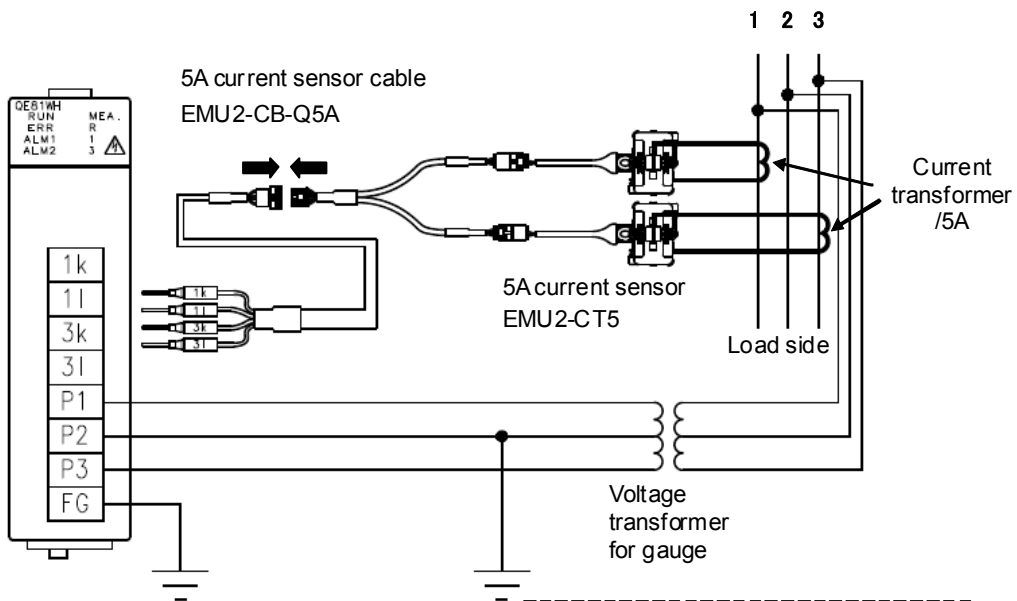

Figure 7.3-2 In the case of Three-phase 3-wire method
(with the voltage transformer for gauge/current transformer)



*For a low voltage circuit, grounding of the secondary sides of VT is not necessary.

Figure 7.3-3 In the case of Single-phase 2-wire method

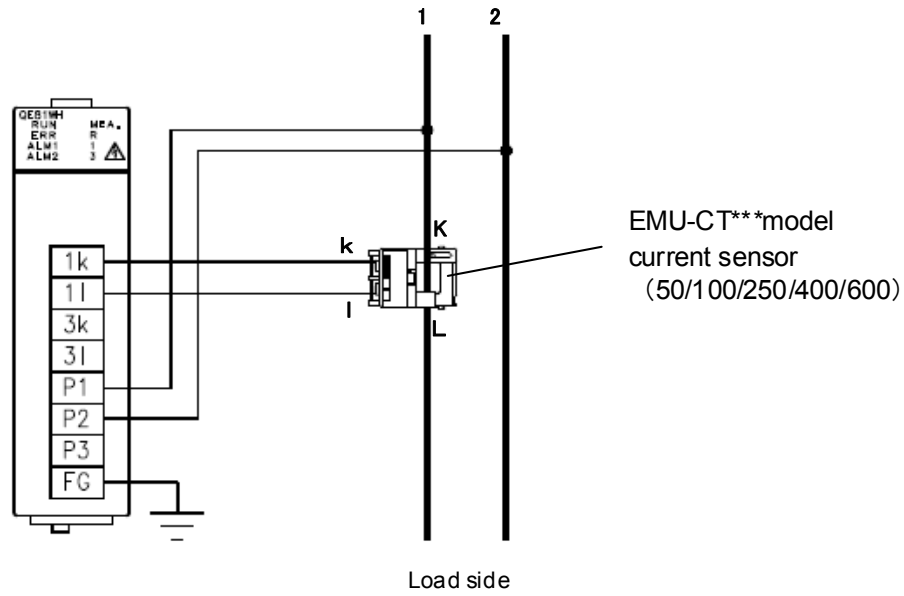
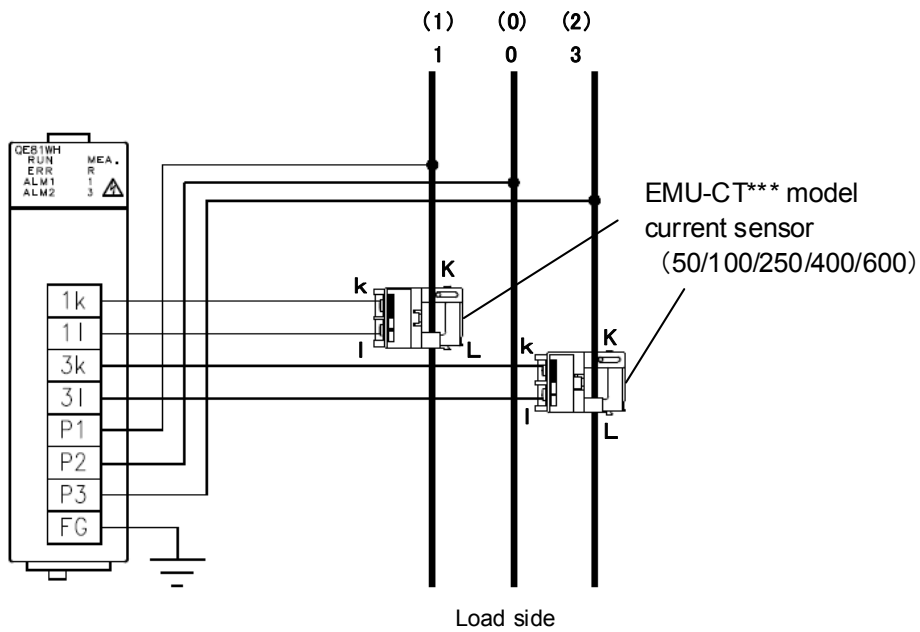

Figure 7.3-4 In the case of Single-phase 3-wire method



7

7.5.3.1 Current circuit connection

For the current circuit connection, there are two ways as follows:

- 1) You can connect current sensor to the circuit, or
- 2) You can attach the 5 A current sensor to the secondary of the existing current transformer.

(1) To attach current sensor (for low voltage circuit) to the circuit

Select an appropriate current sensor according to the current capacity of the circuit to be measured.

Item	Specifications				
Model name	EMU-CT50	EMU-CT100	EMU-CT250	EMU-CT400	EMU-CT600
Primary current	50 A	100 A	250 A	400 A	600 A

✓ **Supplementary**

- Make sure that before connecting the cable, the orientation of the current sensor is correct for attachment. K to L is the correct direction. K: power source side, L: load side.
- The length of the cable to be used for wiring is 50 m max for the following device: EMU-CT50, EMU-CT100, EMU-CT250, EMU-CT400, EMU-CT600.

■ How to attach EMU-CT50/CT100/CT250

Follow the procedure below to attach to the cable of the target circuit.

- 1) Open the movable core, as shown in the figure on the right.
Lift slowly the hooks located on both sides of the movable core, and detach them from the stopper. **Do not force to open it. You may break the hook.**
- 2) Do not let the cable touch on the core-split surface. Thus, carefully pass the cable from underneath. Before passing the cable, check the direction symbols of K and L, in order to attach the sensor in the correct orientation. (Direction from power source side (K) to load side (L) is indicated with the arrow.)
- 3) Make sure no dust or foreign object is attached on the split-core surface, and after that, close the movable core. Lift the movable core until the stoppers are firmly locked. (When the hooks on both side of movable core are locked to the stoppers, you will hear click sound twice.)

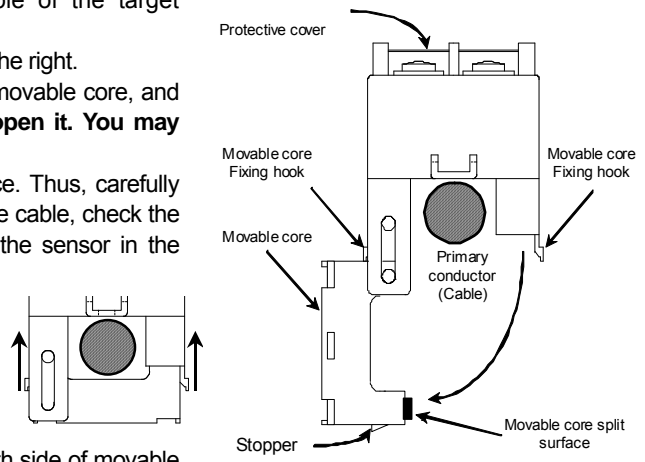

- 4) Put a binding cable through a hole for fixing the current sensor, and then tie it with the cable. Do not tie it too tightly. (Holes for fixing the current sensor are located on both side of the current sensor.)
- 5) Cut off the extra portion of binding cable, using a nipper, etc, to avoid interference of the cable.
- 6) Lift a protective cover of the secondary terminal, by holding the center portion of the protective cover, and remove it. And then, connect the given sensor cable. **Check the terminal symbols printed on the secondary terminal surface, so that connection is performed correctly.**

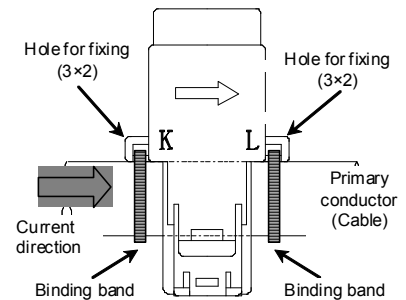

✓ **Supplementary**

- When opening the movable core on current sensor, **do not widen the hook for fixing the movable core too widely.** It may break the hook.
- Refer to the table below for appropriate size of electric wires.

		EMU-CT50	EMU-CT100	EMU-CT250	EMU-CT400	EMU-CT600
Usable wires size (reference)	IV cable	60 mm ² or less	60 mm ² or less	150 mm ² or less	500 mm ² or less	500 mm ² or less
	CV cable	38 mm ² or less	38 mm ² or less	150 mm ² or less	500 mm ² or less	500 mm ² or less

Size of electric wires conforms to what is described in the catalog of general PVC insulated wires. Thickness of external PVC insulation is different for different wire. Check with the external dimension diagram of this product and make sure the wire can go through the given space.



■ How to attach EMU-CT400/CT600

Follow the procedure below to attach the cable to the target circuit.

- 1) Release the band 1) to the arrow direction (top), and detach the core cover.
- 2) Remove the terminal cover, and shift the secondary short switch into "short".
- 3) Loosen the screw 2), and open the core band to remove the core. Make sure that no dust, etc attaches on the core.
- 4) Loosen the screw 3). Put this module onto the cable, and fix the module by tightening the screw 3) using the metal bracket that is directly attached to the cable. Tighten the screw as tightly as the metal bracket will not bend.
- 5) Align the symbol of "K" on the removed core and the "K" on the module to return the core as in the original location. And then, tighten the core band using the screw 2).
- 6) Attach the core cover and fix it with the band 1).
- 7) Connect the secondary terminal with multiple-circuit power measuring module, turn the secondary short switch into "open", and then attach the terminal cover.

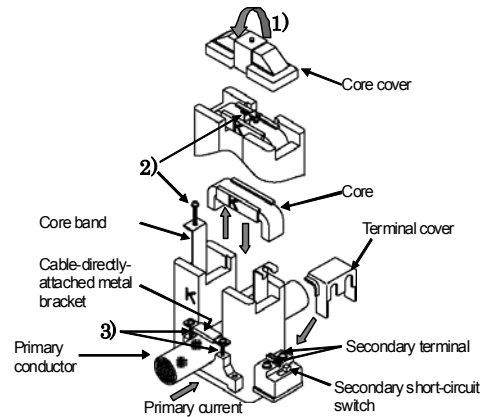

(2) To attach 5 A current sensor to the secondary side of current transformer (/5A rating)

- Transfix EMU2-CT5 current sensor to the secondary-side wire of current transformer (/5A rated). Make sure to use it in a correct combination with 5 A current sensor conversion cable: EMU2-CB-Q5A
- EMU2-CT5 has polarities. Make sure to connect to the right symbol on the terminal. Power source side: (k side), load side: (l side).

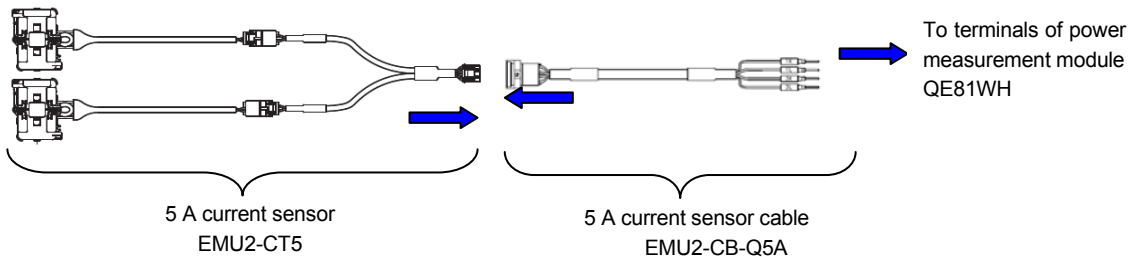

■ How to attach EMU2-CT5

Follow the procedure below to attach the cable to the target circuit.

- 1) Slide the lock pin to the arrow direction.
- 2) Put the electric wire through the clamp, and close the clamp again.
- 3) Use your finger to hold the clamp in the full close position, and push the lock pin until it locks.

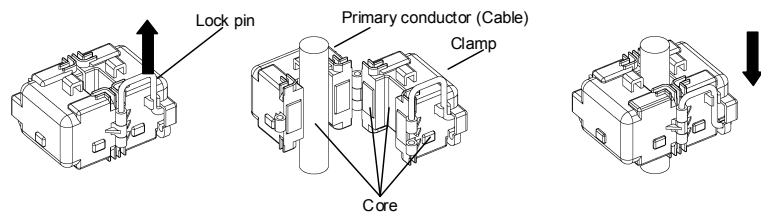

⚠ Caution

- The lock pin is made of metal. If you let it touch electrically charged portions, it may cause electric shock or device failure or fire. Be careful handling the lock pin.
- Physical impact to the core may cause breakage. It may directly influence the performance. Be careful handling the core.
- The mating surface on the core is very sensitive. Even a small foreign object on the surface may affect the measurement performance.
- Excessive force to the core during open clamp may cause breakage. Incorrect direction may cause inaccurate measurement.
- For both the transfixing wire and the binding band for fixing the sensor, use the size of W=2.6 mm or less. To fix them together Put a binding band through a hole for fixing the current sensor, and tie it with the cable. Do not tie it too tightly. (Total four holes for fixing the current sensor exist on both sides of the current sensor).

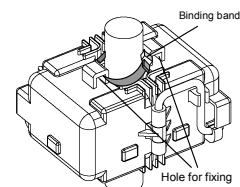

■ When wiring single-phase 2-wire circuit

5 A current sensor is not used L3. As shown below, L3 remove connector , and connector with insulating tape.

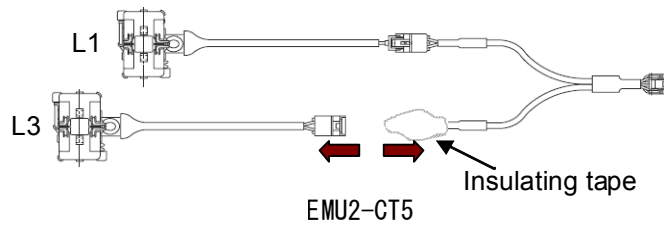

■ Extending the cable of 5 A current sensor

If the cable from current sensor is too short, you can extend it by using an extension cable as shown below.

Extension cable (standard)

Model name	EMU2-CB-T1M	EMU2-CB-T5M	EMU2-CB-T10M
Cable length	1 m	5 m	10 m

Extension cable (separate)

Model name	EMU2-CB-T1MS	EMU2-CB-T5MS	EMU2-CB-T10MS
Cable length	1 m	5 m	10 m

Connecting 5 A current sensor and the cable

◆ Connecting 5 A current sensor and extension cable (standard)

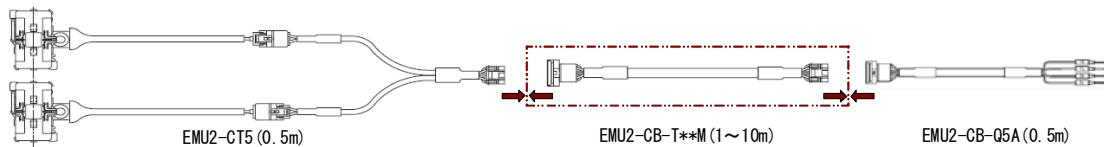

◆ Connecting 5 A current sensor and extension cable (separate)

1)

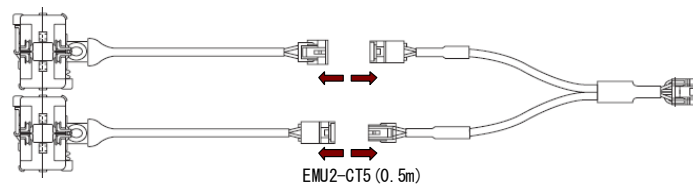

2)

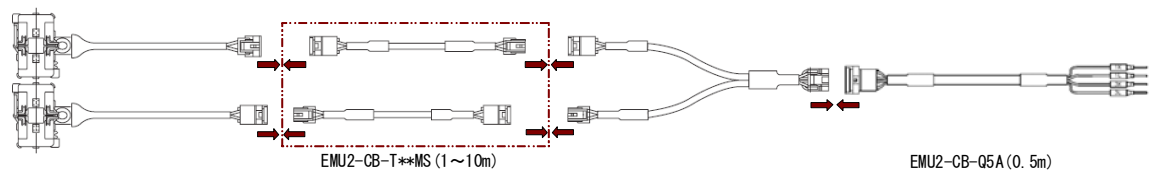

✓ **Supplementary**

- Cable extension for EMU2-CT5 is 10 m max. (Total cable length is 11m max.)
- Use extension cable (separate) when 1-phase and 3-phase are set apart.

7.5.3.2 Voltage circuit connection

- If a 440 V or higher circuit is used, use a transformer.
- The available transformer ratio is 440 V to 6600 V/110 V. For connection to P1 to P3 terminals on QE81WH, connect the secondary of transformer. Make sure that terminal symbols are correct.
- In order to perform maintenance work such as changing the wire layout and replacing equipment, we recommend that you connect protective device (breaker or fuse) for the voltage input circuit (P1, P2, and P3 terminals).

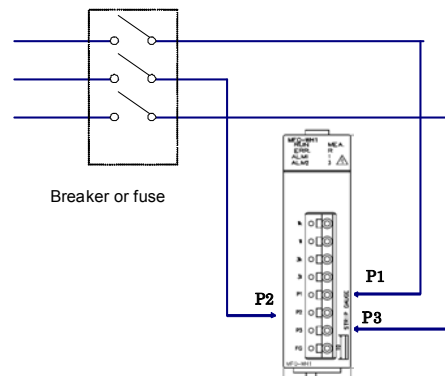

7.5.3.3 FG terminal connection

- For the actual usage, connect the FG terminal to ground. (D-type ground: Type 3) Connect it directly to the ground terminal.
- Do not connect to FG terminal during the insulation resistance test and pressure test.

7.6 Setting from GX Developer

This section explains setting from GX Developer necessary to use QE81WH. Before performing this setting, install GX Developer and connect the Management CPU with the PC using a USB cable. For details, refer to the manual of CPU module.

7.6.1 I/O assignment setting

- (1) Double-click the dialog box of "PLC Parameter" in the GX Developer Project.
- (2) Click "I/O assignment".
- (3) Set the following item to the slot*1 to which QE81WH has been attached.

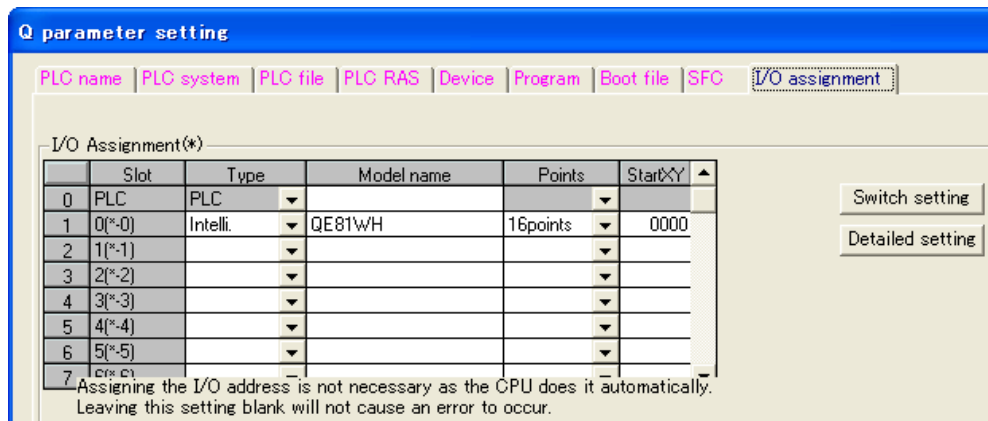

Figure 7.10 Dialog box of "I/O assignment"

Table 7.6 Setting items on the "I/O assignment" tab

Item	Descriptions
Type	Select "Intelli."
Model name	Enter the model name of the module.
Points	Select 16 points.
Start XY	Enter the initial I/O number of QE81WH.

*1 is a case where QE81WH is attached to the slot 0.

7.6.2 Setting the intelligent function of the module switch

- (1) In the “I/O assignment” of 7.6.1, click the **Switch setting** button to display the dialog box of “I/O module, intelligent function module switch setting”.
- (2) The intelligent function module switch setting displays switches 1 to 5; however, only the switch 5 is used for this purpose. Switch setting is configured using 16-bit data. Settings are as shown in Table 7.8.

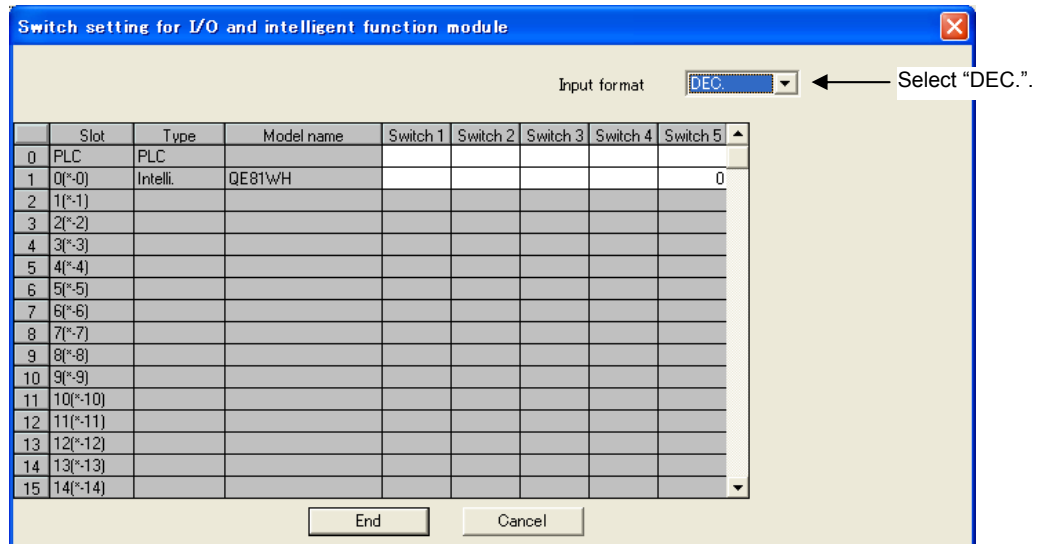

Figure 7.13 Dialog box to set the intelligent function of the module switch

Table 7.8 Setting the intelligent function of the module switch

Swith No.	Switch name	Description
1	Not used	-
2	Not used	-
3	Not used	-
4	Not used	-
5	Test mode transition	0: Normal operation (Even if it is not set, normal operation is performed) 1: Test mode * For details of test mode, refer to 4.2.5.

- (3) When the setting is completed, click the Complete setting button.
- (4) From the “Online” menu, select “Write to PLC” to display the dialog box of Write to PLC, and then execute the writing to PLC parameter. After resetting the CPU module, the value will become effective.

7.6.3 Initial setting

This section explains the setting of the operating condition for phase wire system, primary voltage, primary current, current demand time, and voltage demand time that are required for measurement. Once each value is set, these values will be stored in the nonvolatile memory of the module, so that reconfiguration is not needed. You can also perform the setting using sequence program. In this case, you need to create a program, as referring to Chapter 8.

Follow the procedure below for each setting.

- (1) Check the current setting
 - (2) Set the Buffer memory
-
- (1) Check the current setting
 - 1) From the “Online” menu, select “Monitor” – “Buffer memory batch ...”. The dialog box to monitor all buffer memories. After setting the address as shown below, click the **Start monitoring** button to check the current buffer memory status.
 - Module initial address: Set the initial address of this module.
 - Buffer memory address: 0
 - (Display: 16-bit integer, numerical value: check the number in decimal)
 - 2) Check each item. The following shows items for operating condition settings. For specific setting value, see the provided references.

Table 7.9 List of setting items

Buffer memory address	Item	Reference
Un%G0	Phase wire system	Section 6.2.1
Un%G1	Primary voltage	Section 6.2.2
Un%G2	Primary current	Section 6.2.3
Un%G3	Current demand time	Section 6.2.4
Un%G4	Electric power demand time	Section 6.2.5

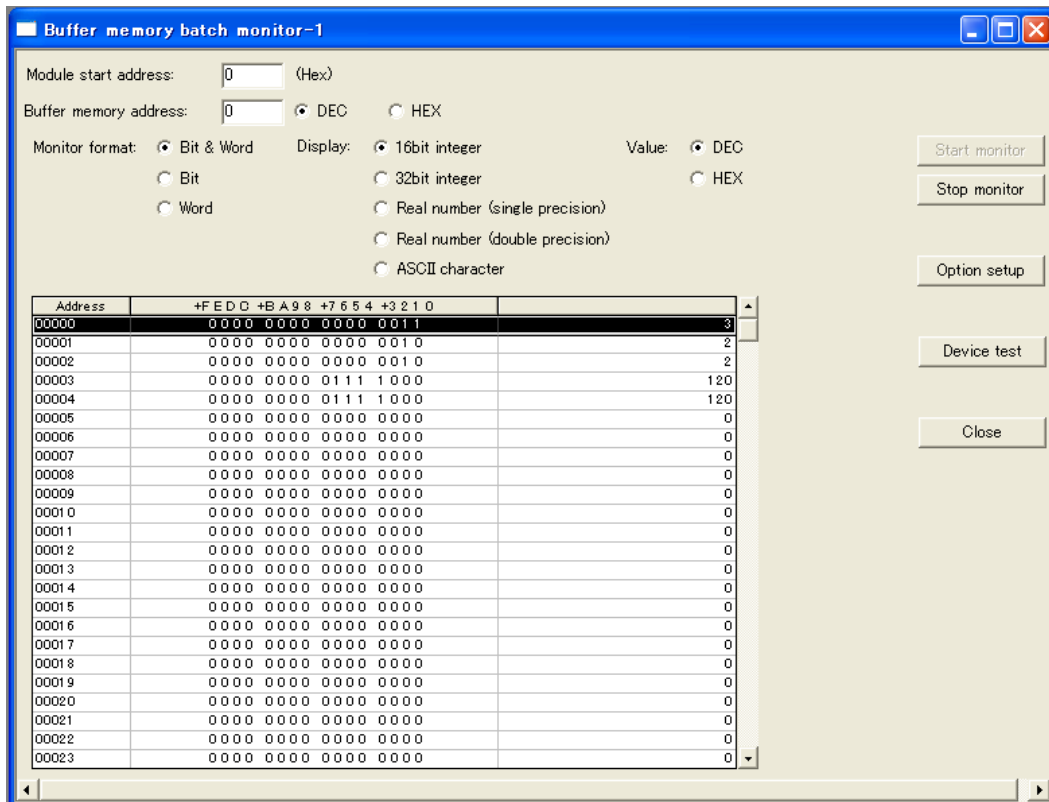

Figure 7.14 Dialog box to monitor all buffer memories (a case where the module is attached to the slot 0)

- (2) Set the Buffer memory
 - 1) In the dialog box to monitor all buffer memories, click the **Device test** button to display the Device test dialog box.
 - 2) In the Word device / buffer memory, specify the module initial address and buffer address, and click the **Set** button to apply the setting.

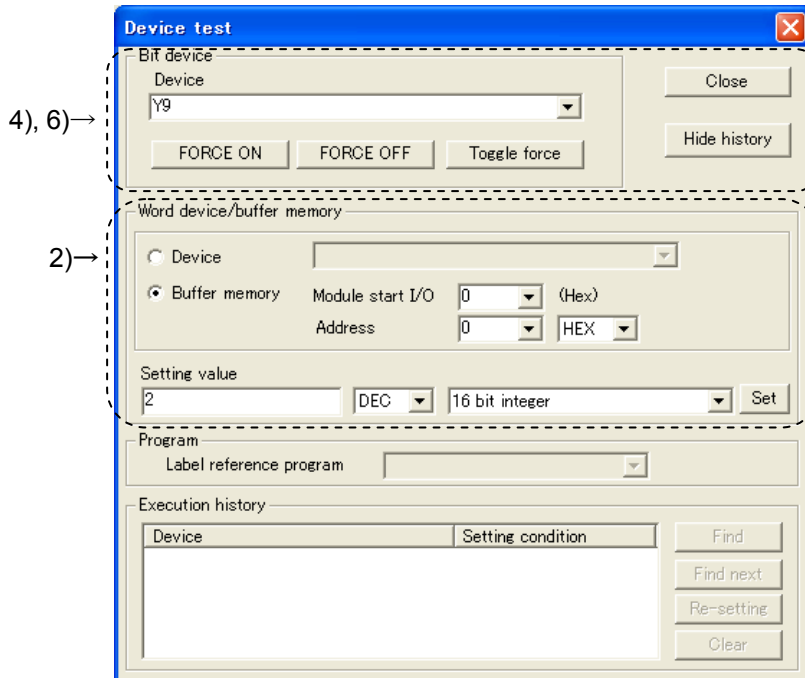

Figure 7.15 Device test dialog box (a case where this module is attached to the slot 0)

- 3) Change the setting in 2).
- 4) In the section of bit device setting in the device test dialog box, select “Y9”^{*} and click the **FORCE ON** button.
- 5) When the setting is completed without any problem, the Device “X9”^{*} changes to ON. Check this using the procedure as follows:
 - (a) From the “Online” menu, select “Monitor” – “Device batch ...”. The dialog box to monitor all devices is displayed.
 - (b) Set “X0”^{*} to the device, and click “Start monitor”
 - (c) Check that Device “X9”^{*} is in the ON status.

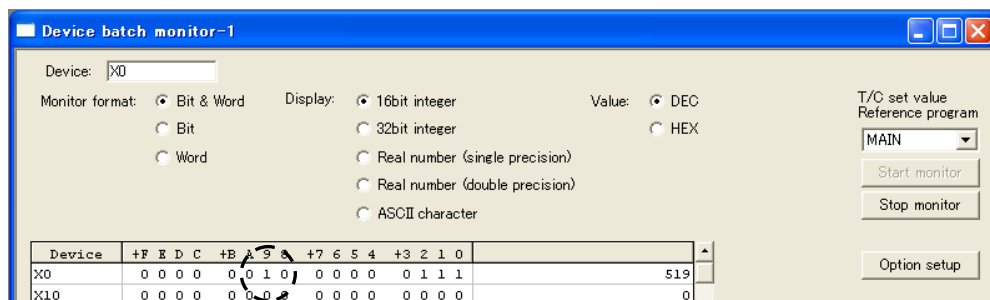

Figure 7.16 Checking the device “X9”^{*} in the dialog box to monitor all devices

- 6) After checking that the device “X9”^{*} is in the ON status, select “Device: “Y9”^{*} in the dialog box of device test, and then click the **FORCE OFF** button. Setting is completes.
 - 7) If the Device “X9”^{*} is not in the ON status, this means an error because the set value is out of range (ERR.LED is flashing). Modify the setting, and change the device “Y9” to the OFF status, then change it back to the ON status.
- ^{*} Indicates a number in the case where the initial I/O number (initial XY) is set to 0.

7.6.4 Debugging program

QE81WH provides a test function so that you can debug a program with no input of voltage or current. Pseudo-value can be stored into the buffer memory. For detailed explanation for the test function, refer to 4.2.5.

**Caution**

Test function stores pseudo-values for setting value and error information as well as measured value. If you use these data to control the sequence program that controls external devices, there is a chance that erroneous control may occur. For safety of external devices, use this function after disconnecting the device.

- (1) Setting intelligent function of the module switch
 - 1) In the "I/O assignment setting" of 7.6.1, click the **Switch setting** button to display the dialog box of "I/O module, intelligent function module switch setting".
 - 2) The intelligent function module switch setting displays switches 1 to 5; however, only the switch 5 is used for this purpose. Switch setting is configured using 16-bit data.
Setting is as follows:
Switch 5: "1"
 - 3) When the setting is completed, click the **End** button.
 - 4) From the "Online" menu, select "Write to PLC" to display the dialog box of Write to PLC, and then execute the writing to PLC parameter. After resetting the CPU module, the value will become effective.
- (2) Starting the test function
 - 1) Reset the CPU module.
 - 2) QE81WH starts in the test function mode. All LEDs are turned on. Pseudo-values are set effective in the buffer memory.
- (3) Finishing the test function (Move back to the normal operation)
 - 1) Following 1) and 2) in step (1), configure the intelligent function switch setting as shown below.
Switch 5: "0"
 - 2) Following 3) and 4) in step (1), complete the setting and write the data into PLC.
 - 3) Reset the CPU module, then the operation goes back to the normal operation.

Chapter 8: Programming

This chapter explains about programming for QE81WH.

When you apply sample programs introduced in this chapter into the actual system, make sure to verify in advance that there is no problem with the target system control.

Follow the procedure in Figure 8.1 to create a sample program using QE81WH.

The default setting allows you to use either GX Developer (see 7.5) or the sequence program to make setting; however, if the setting is made for the first time by using GX Developer, the program for initial setting can be eliminate, which will reduce time for scanning.

8.1 Programming procedure

Follow the procedure in Figure 8.1 to create a program for acquiring the measured data, alarm monitoring, calculating periodical electricity amount using QE81WH.

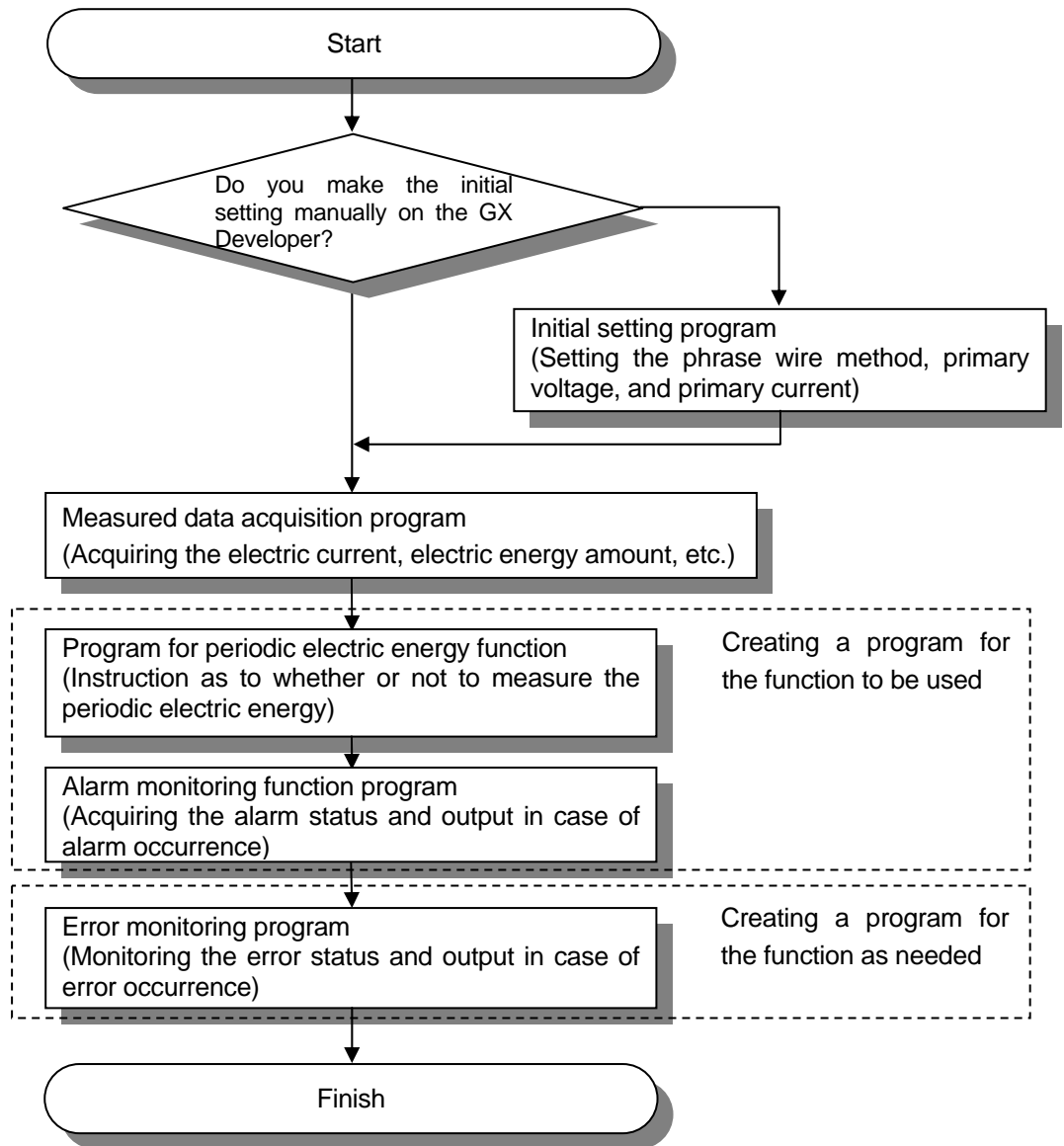

Figure 8.1 Programming chart

8.2 System configuration and usage conditions for sample program

A sample program under the following system and the usage condition is shown below.

(1) System configuration

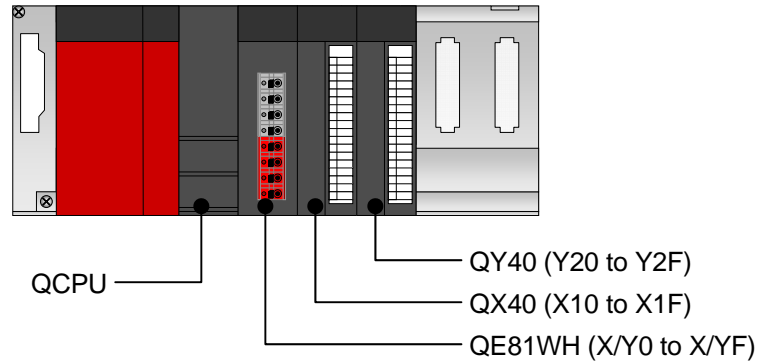

Figure 8.2 Sample system configuration using a sample program

(2) Setting conditions for the intelligent function of the module switch

Setting is as follows:

Table 8.1 Setting the intelligent function of the module switch

Switch No.	Switch name	Description
1	Not used	-
2	Not used	-
3	Not used	-
4	Not used	-
5	Test mode transition	0 (Normal operation)

(3) Programming conditions

(a) Setting the operating conditions

- Phase wire : Three-phase 3-wire
- Primary voltage : 220 V
- Primary current : 250 A
- Current demand time : 30 sec
- Electric power demand time : 30 sec

(b) Alarm monitoring setting

- Alarm 1 item : Current demand upper limit
- Alarm 1 value : 100000 (100 A)
- Alarm 1 reset method : Auto reset
- Alarm 1 delay time : 5 sec
- Alarm 2 item : Current demand upper limit
- Alarm 2 value : 120000 (120 A)
- Alarm 2 reset method : Self-retention
- Alarm 2 delay time : 5 sec

(4) Before creating a program

Before creating a program, attach QE81WH to the base unit, and connect it to external devices.

Current sensor: EMU-CT250

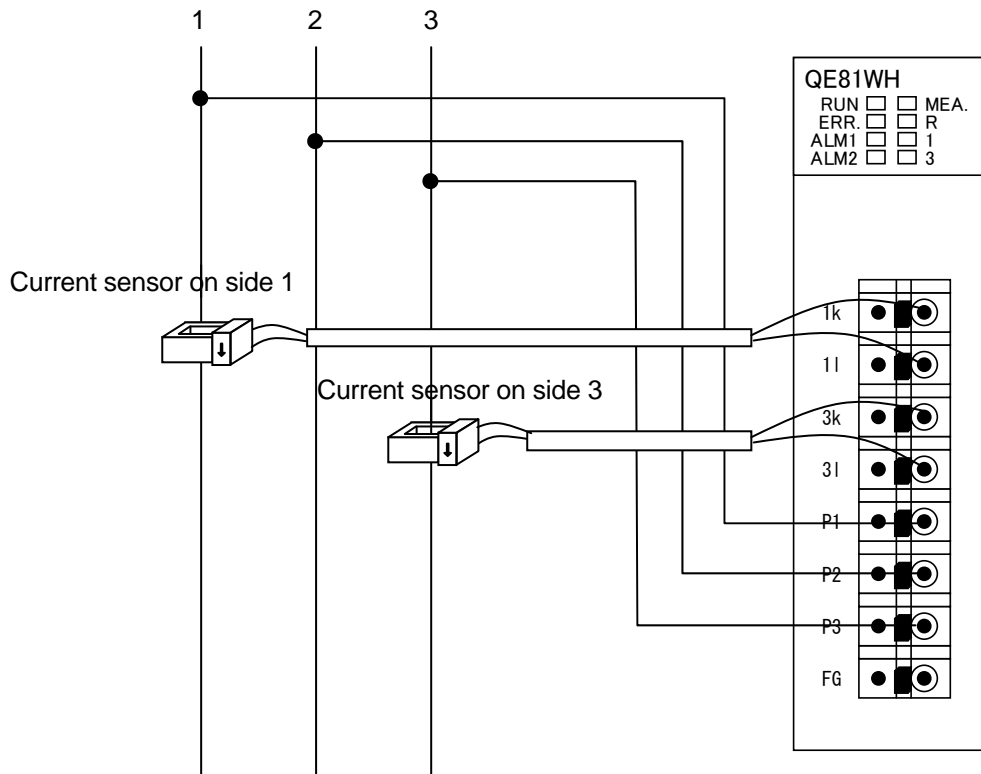

Figure 8.3 Example of wiring using a sample program

8.3 Sample programming

(1) List of devices

Table 8.2 List of devices

Device	Function	
D0, D1	Device that stores Multiplier of electric energy	
D2, D3	Device that stores electric energy (consumption)	
D4, D5	Device that stores average current	
D6, D7	Device that stores average voltage	
D8, D9	Device that stores electric energy	
D10, D11	Device that stores power factor	
D12, D13	Device that stores frequency	
D20	Device that stores latest error code	
X0	Module ready	QE81WH (X/Y0 to X/YF)
X9	Operating condition setting completion flag	
XA	Alarm 1 flag	
XB	Alarm 2 flag	
XF	Error flag	
Y1	Periodic electric energy 1 measurement flag	
Y2	Periodic electric energy 2 measurement flag	
Y9	Operating condition setting request	
X10	Device that the user will turn ON in order to support measurement of periodic electric energy	QX40 (X10 to X1F)
Y20	Device that turns ON to send an output to the external device when the alarm 1 occurs	QY40 (Y20 to Y2F)
Y21	Device that turns ON to send an output to the external device when the alarm 2 occurs	
Y22	Device that turns ON to send an output to the external device in the case of an error	

(2) List of buffer memories to be used

Table 8.3 List of buffer memories to be used

Device	Description	Setting value	Remarks
U0¥G0	Phase wire method	3	Three-phase 3-wire
U0¥G1	Primary voltage	2	220 V
U0¥G2	Primary current	3	250 A
U0¥G3	Current demand time	30	30 sec
U0¥G4	Electric power demand time	30	30 sec
U0¥G11	Alarm 1 item	1	Current demand upper limit
U0¥G12, 13	Alarm 1 value	100000	100 A
U0¥G14	Alarm 1 reset method	1	Auto reset
U0¥G15	Alarm 1 delay time	5	5 sec
U0¥G21	Alarm 2 item	1	Current demand upper limit
U0¥G22, 23	Alarm 2 value	120000	120 A
U0¥G24	Alarm 2 reset method	0	Self-retention
U0¥G25	Alarm 2 delay time	5	5 sec
U0¥G100	Multiplier of electric energy	-	Stores multiplier of electric energy
U0¥G102, 103	Electric energy (consumption)	-	Stores electric energy
U0¥G218, 219	Average current	-	Stores average current
U0¥G314, 315	Average voltage	-	Stores average voltage
U0¥G402, 403	Active energy	-	Stores active energy
U0¥G702, 703	Power factor	-	Stores power factor
U0¥G802, 803	Frequency	-	Stores frequency
U0¥G3000	Latest error code	-	Stores latest error code

(3) Sample program

1. Initial setting program for QE81WH

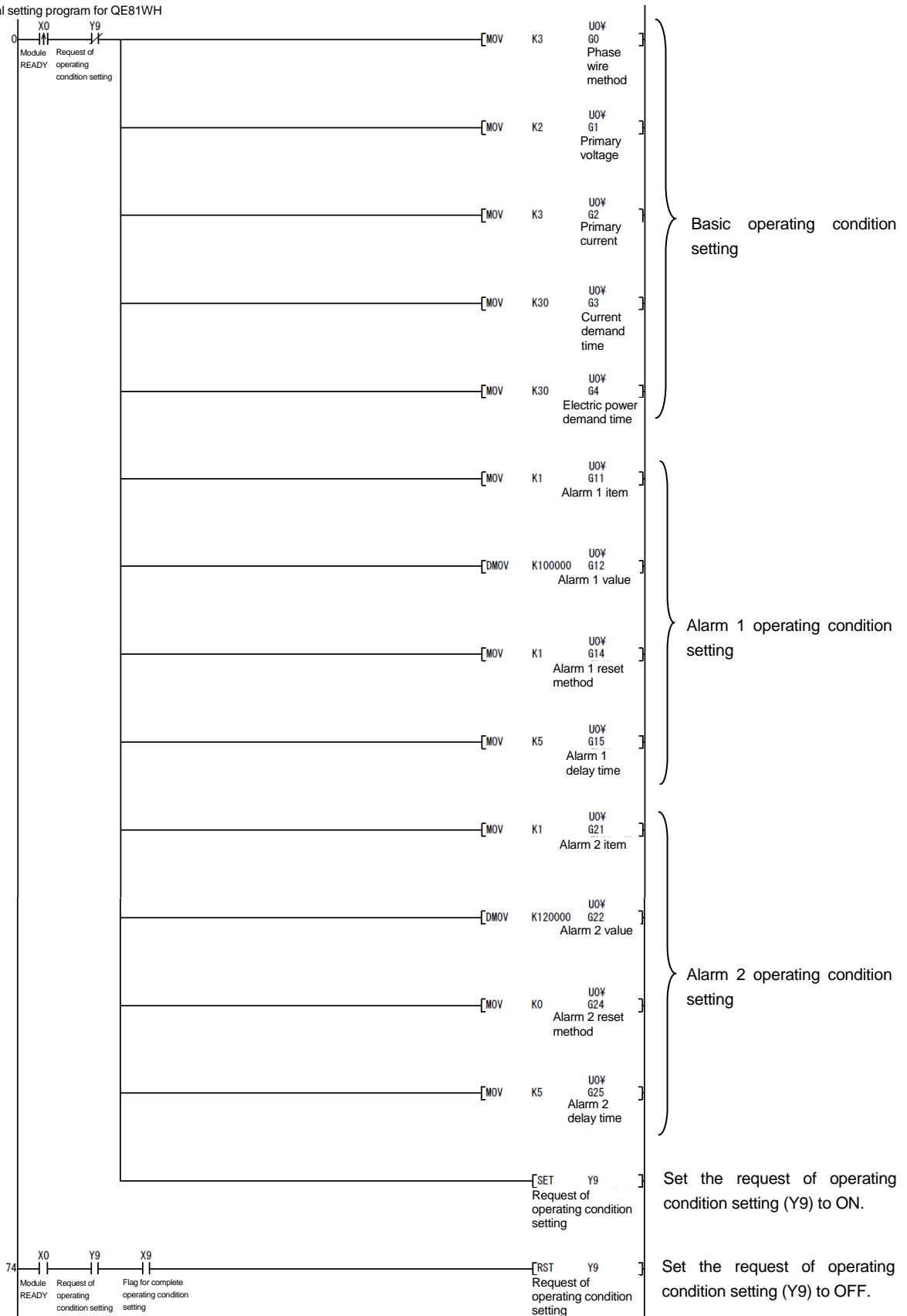

Figure 8.4 Example of a sample program

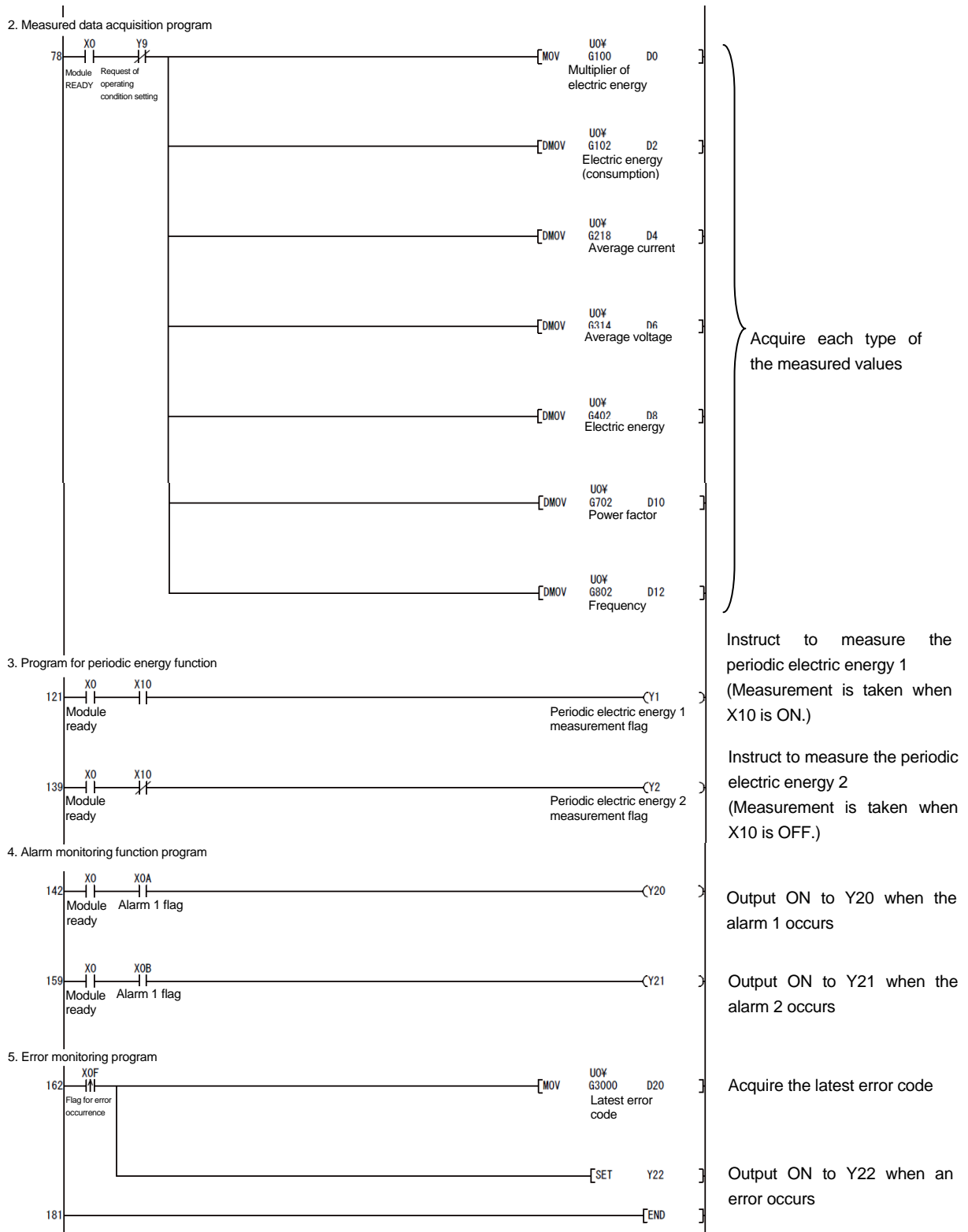

Figure 8.4 Example of a sample program (continued)

Chapter 9: Troubleshooting

9.1 List of error codes

When the data are written to the CPU module from this module or when a reading error occurs, error codes will be stored into the following buffer memory.

Table 9.1 Latest error code, storage destination upon error occurrence

Latest error code	Time of error occurrence
Un¥G3000	Un¥G3001 to Un¥G3004

Table below shows error codes.

Table 9.2 List of error codes

Error code (HEX)	Error level	Descriptions	Action	Reference
0001h 0002h 0003h	Mid	Hardware error with the module.	Turn the power OFF/ON. If the error recurs, the module may have a failure. Consult with a nearest sales agent or our company branch for the symptom of the failure.	-
1001h	Low	Phase wire method (Un¥G0) is set out of range.	Check phase wire method, and set it within 1-3.	Section 6.2.1
1002h	Low	Primary voltage (Un¥G1) is set out of range.	Set it within 1 to 9 according to the primary voltage.	Section 6.2.2
1003h	Low	Primary current (Un¥G2) is set out of range.	Set it within the range* of 1 to 5, 501 to 536 according to the primary current.	Section 6.2.3
1004h	Low	Current demand time (Un¥G3) is set out of range.	Set current demand time within the range* of 0 to 1800 (seconds).	Section 6.2.4
1005h	Low	Electric power demand time (Un¥G4) is set out of range.	Set electric power demand time within the range* of 0 to 1800 (seconds).	Section 6.2.5
1006h	Low	Alarm 1 item (Un¥G11) is set out of range.	Set alarm 1 item within 1 to 8.	Section 6.2.6
1007h	Low	Alarm 2 item (Un¥G21) is set out of range.	Set alarm 2 item within 1 to 8.	Section 6.2.6
1008h	Low	Alarm 1 reset method (Un¥G14) is set out of range.	Set alarm 1 reset method within 0 to 1.	Section 6.2.8
1009h	Low	Alarm 2 reset method (Un¥G24) is set out of range.	Set alarm 2 reset method within 0 to 1.	Section 6.2.8
100Ah	Low	Alarm 1 delay time (Un¥G15) is set out of range.	Set alarm 1 delay time within the range* of 0 to 300 (seconds).	Section 6.2.9
100Bh	Low	Alarm 2 delay time (Un¥G25) is set out of range.	Set alarm 2 delay time within the range* of 0 to 300 (seconds).	Section 6.2.9
100Ch	Low	Electric energy preset value (Un¥G52, 53) is set out of range.	Set electric energy preset value within the range* of 0 to 999999999 in the double word format (32-bit integer).	Section 6.2.10
0000h	-	Normal	-	-

* Also check that it is set in decimal.



9.2 Troubleshooting

9.2.1 When "RUN" LED is turned off

Table 9.3 When "RUN" LED is turned off

Check item	Action	Reference
Is power source is supplied?	Check that supply voltage of the power source is within the rating.	Section 3.1
Is capacity of the power source module sufficient?	Calculate the consumption current of CPU module, I/O module, and intelligent function module attached to the base unit, and check that the power capacity is sufficient.	-
Is the watchdog time an error?	Reset CPU module, and check whether it is turned on. If RUN LED is not turned on even after doing the above, the module may have a failure. Consult with a nearest sales agent or our company branch for the symptom of the failure.	-
Is the module properly attached to the base unit?	Check the module attachment status.	-
Is the slot type set to "empty" in the I/O assignment setting of the PC parameter at GX Developer?	Set the slot type to "Intelligent".	Section 7.5.1

9.2.2 When "ERR." LED is turned on or flashing

(1) If it is ON

Table 9.4 When "ERR." LED is turned on

Check item	Action	Reference
Did any error occur?	Check latest error code (Un#G3000), and take a corrective action as described in section 9.1. After that, reset CPU module, and check whether it is turned on. If "ERR." LED is turned on even after doing the above, the module may have a failure. Consult with a nearest sales agent or our company branch for the symptom of the failure.	Section 9.1

(2) If it is flashing

Table 9.5 When "ERR." LED is flashing

Check item	Action	Reference
Did any error occur?	The set value may be out of range. Check that the operating condition settings and the integrated value are correct. Correct configuration or changing the request for error clear (YF*) to ON will recover the error. When the error is cleared using the error clear request (YF*), the operation continues with the previous setting. * In the case where the initial I/O number of this module is 0	Section 7.5.3 Section 6 Section 5.2.2

9.2.3 If electric energy cannot be measured

The following check has to be performed while current is flowing from the power source side to the load side.

Table 9.6 If electric energy cannot be measured

Check item			Action	Reference
"MEA." LED	"R" LED	"1" "3" LED		
OFF	OFF	Both "1" and "3" LED are OFF.	The type of current sensor may be incorrect. In addition, if the rating of the used sensor is different from the primary current, measurement cannot be taken correctly.	Section 7.4
			Wiring is not done or wrong. Refer to 7.4 to check the wiring.	
			Voltage wiring may be incorrect. Check connection of P1, P2, and P3.	
ON	ON	Both "1" and "3" LED are ON.	Current sensors on both 1 side and 3 side may be installed in the reverse direction. Check the connection.	
			Voltage wiring may be incorrect. Check connection of P1, P2, and P3.	
	OFF or ON	Only "1" is ON.	Current sensor on side 1 may be installed in the reverse order or current sensors on side 1 and side 3 may be swapped. Check the connection.	
			Connection between P1 and P2 or P1 and P3 may be reserved. Check the connection.	
		Only "3" is ON.	Current sensor on side 3 may be installed in the reverse order or current sensors on side 1 and side 3 may be swapped. Check the connection.	
			Connection between P2 and P3 or P1 and P3 may be reserved. Check the connection.	
OFF	OFF	Both "1" and "3" LED are OFF.	Measurement is taken normally. Check for the correct buffer memory address and data format (double word: 32-bit integer).	

9.2.4 If the electric current and voltage that are measured using this module do not match with the ones measured with other gauge

Table 9.7 If current and voltage that are measured using this module do not match with the ones measured with other gauge

Check item	Action	Reference
Are phase wire method, primary current, and primary voltage correct?	Check the value in the buffer memory for checking the phase wire method, primary current and primary voltage. When the value in the buffer memory is changed, you need to turn the request for operating condition setting into ON. Otherwise, it will not be applied to the measurement.	Section 7.5.3
Does the compared gauge measure the effective value correctly?	This module stores the effective value into the buffer memory. If the compared device uses the average value instead of the effective value, the resulted value may largely differ when there is current distortion in the measurement circuit.	-
Is the secondary of CT short-circuited?	Make sure that the secondary of CT is not short-circuited. If it is connected to Mitsubishi's current transformer CW-5S(L), check that the secondary switch is not short-circuited.	-
Are you using other current sensor than recommended ones?	Only the dedicated current sensors can be connected to this module. Check that other company's sensor is not being used.	-

Appendix

Appendix 1: External dimensions

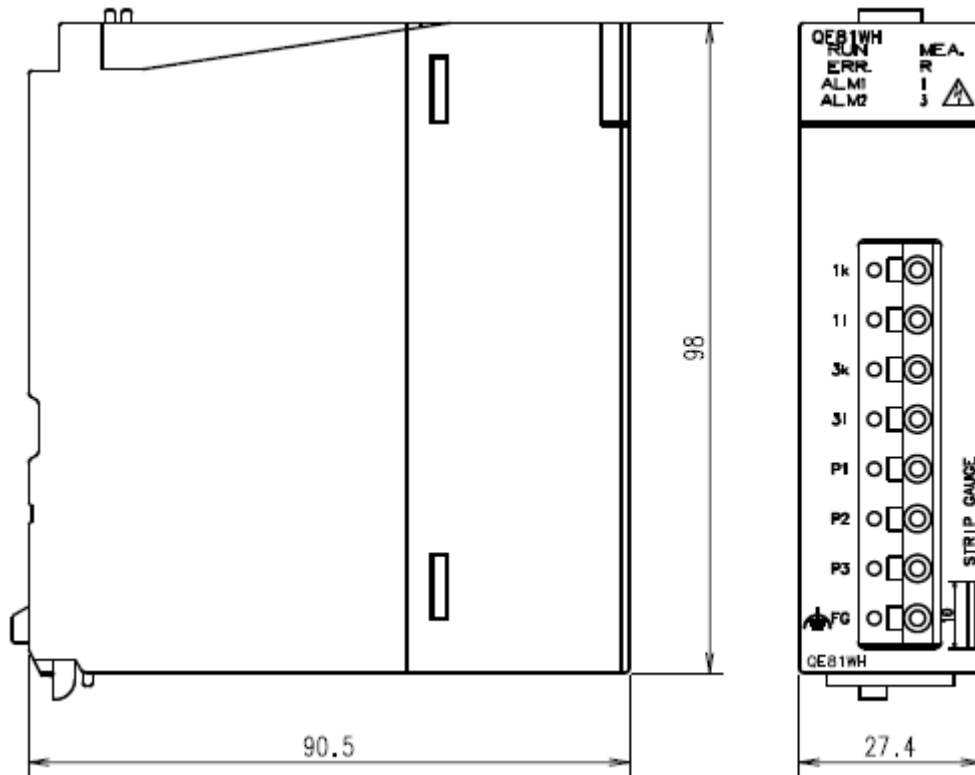

Unit [mm]

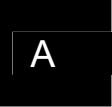

Appendix 2: Optional devices

■ Current sensor

◆ EMU-CT50, EMU-CT100, EMU-CT250

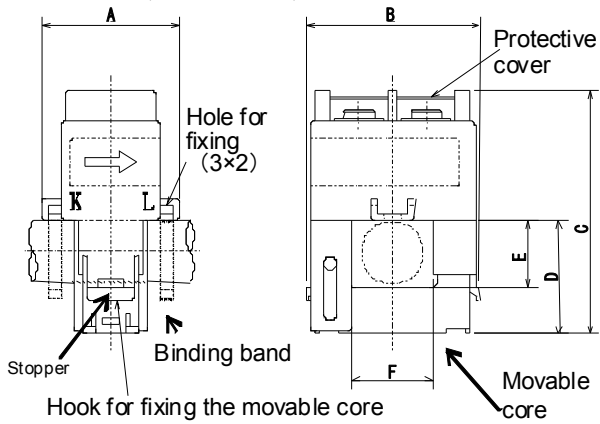

Model	A	B	C	D	E	F
EMU-CT50/CT100	31.5	39.6	55.2	25.7	15.2	18.8
EMU-CT250	36.5	44.8	66	32.5	22	24

◆ EMU-CT400, EMU-CT600

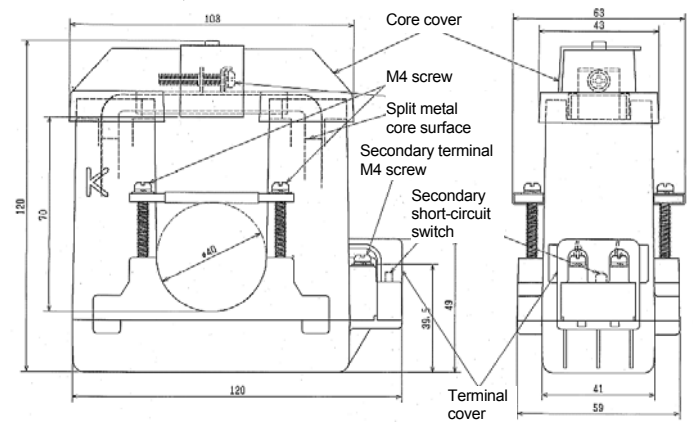

Unit [mm]

◆ EMU2-CT5

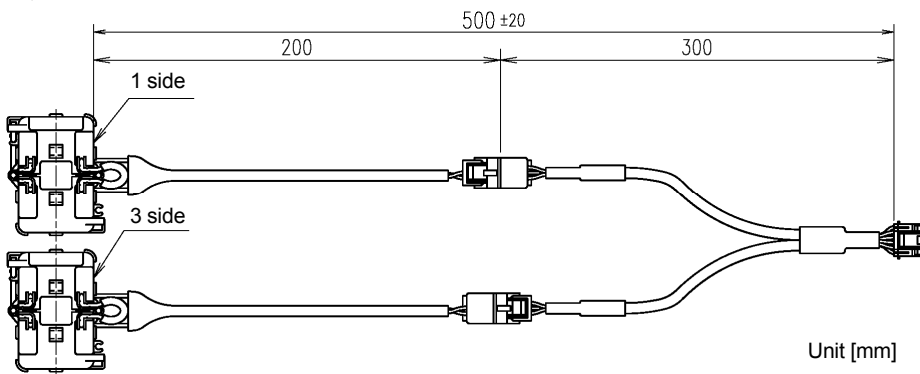

Unit [mm]

Sensor in detail

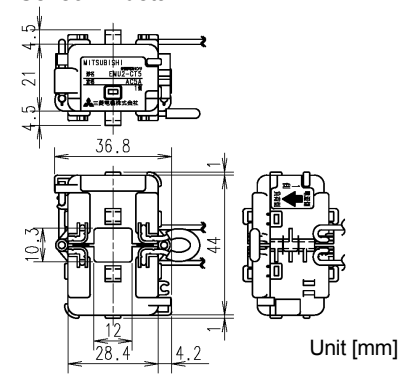

Unit [mm]

■ Dedicated cable

- ◆ 5A current sensor cable EMU2-CB-Q5A

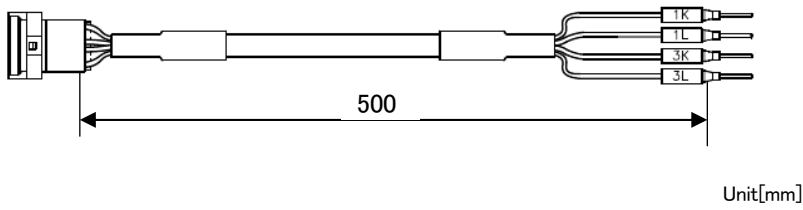

- ◆ Extension cable(standard) EMU2-CB-T**M

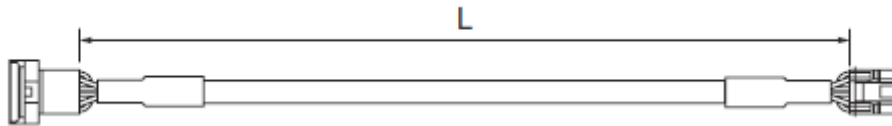

Model	EMU2-CB-T1M	EMU2-CB-T5M	EMU2-CB-T10M
Length	1000mm	5000mm	10000mm

- ◆ Extension cable(separate) EMU2-CB-T**MS

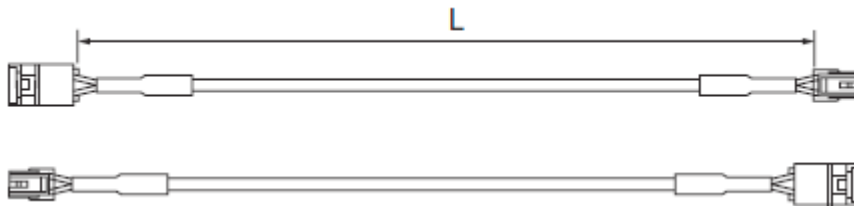

Model	EMU2-CB-T1MS	EMU2-CB-T5MS	EMU2-CB-T10MS
Length	1000mm	5000mm	10000mm

Index

【5】

- 5A current sensor 7-10
- 5A current sensor cable7-10

【A】

- Alarm 1 flag (XnA) 5-3
- Alarm 1 reset request (YnA) 5-6
- Alarm 2 flag (XnB) 5-3
- Alarm 2 reset request (YnB) 5-6
- Alarm flag 4-16
- Alarm mask time..... 4-13
- Alarm reset method..... 4-13
- Applicable wire 7-6
- Average current..... 4-3
- Average voltage 4-3

【B】

- Bar terminal 7-6

【C】

- Current demand time 4-16, 6-8

【D】

- Demand value 4-1, 4-2

【E】

- Electric energy (consumption) 4-1
- Electric energy (regeneration) 4-1
- Electric energy preset completion flag (XnC) · 5-4
- Electric energy preset request (YnC) 5-6
- EMU2-CT5..... 7-10
- EMU-CT50/100/250/400/600..... 7-9
- Error clear request (YnF) 5-6
- Error flag (XnF) 5-4
- External dimensions..... A-1

【F】

- Flag for periodic electric energy..... 4-9
- Full load power 4-4

【H】

- Max./min. value hold function 4-12

【L】

- List of functions 4-1
- List of I/O signals..... 5-1

【M】

- Max./min. values clear completion flag (XnD)
..... 4-12,5-4
- Max./min. values clear request (YnD) ... 4-12, 5-6

【N】

- Name of each part..... 7- 3

【O】

- Operating condition setting completion flag (Xn9)
.....5-3
- Operating condition setting request (Yn9).....5-5
- Output signal5-5

【P】

- Periodic electric energy..... 4-1, 4-9
- Periodic electric energy 1 data completion flag
(Xn1)5-2
- Periodic electric energy 1 measurement flag
(Yn1)5-5
- Periodic electric energy 1 reset completion flag
(Xn3)5-2
- Periodic electric energy 1 reset request (Yn3)5-5
- Periodic electric energy 2 data completion flag
(Xn2)5-2
- Periodic electric energy 2 measurement flag
(Yn2)5-5
- Periodic electric energy 2 reset completion flag
(Xn4)5-2
- Periodic electric energy 2 reset request (Yn4)5-5
- Periodic electric energy reset 4-10
- Phase wire method 4-2, 7-7
- Power demand time 4-16, 6-8
- Primary current.....4-4
- Primary voltage4-4
- Programming.....8-1

【T】

- Test..... 4-1, 4-17
- Test function 4-17
- Troubleshooting9-1

【U】

- Unit ready (Xn0)5-2
- Upper/lower limit alarm monitoring..... 4-1, 4-13

【W】

- Wiring diagram7-7

Warranty

For using this product, please thoroughly read the following product warranty descriptions.

1. Gratis Warranty Period and Gratis Warranty Coverage

If any failure or defect (hereinafter collectively called "failures") for which our company is held responsible occurs on the product during the gratis warranty period, our company shall replace the product for free through the distributor at which you purchased the product or our service company.

However, if an international travel is required for replacement, or a travel to an isolated island or remote location equivalent is required for replacement, the actual cost incurred to send an engineer(s) shall be charged.

[Gratis Warranty Period]

The gratis warranty term of the product shall be for one year after the date of purchase or delivery to a designated place.

Note that after manufacture and shipment from Mitsubishi, the maximum distribution period shall be six (6) months, and the longest gratis warranty term after manufacturing shall be eighteen (18) months. The gratis warranty term of repair parts shall not exceed the gratis warranty term before repairs.

[Gratis Warranty Coverage]

- (1) The gratis warranty shall apply only if the product is being used properly in the conditions, with the methods and under the environments in accordance with the terms and precautions described in the instruction manual, user's manual, caution label on the product, etc.
- (2) Replacement shall be charged for the following cases even during the gratis warranty period.
 - 1) Failures occurring due to your improper storage or handling, carelessness or fault, and failures arising from the design contents of hardware or software you use.
 - 2) Failures arising from modification you performed on the product without prior consent of our company.
 - 3) Failures occurring in the event that the product is assembled into the device you use and that are acknowledged as avoidable if the device is equipped with a safety mechanism that comply with the legal regulations applicable to the device or with functions/architecture which are considered as necessary to be equipped under conventions of the industry.
 - 4) Failures due to accidental force such as a fire, abnormal voltage, etc. and force majeure such as an earthquake, thunderstorm, wind, flood, etc.
 - 5) Failures due to matters unpredictable based on the level of science technology at the time of product
 - 6) Other failures which are beyond responsibility of our company or which you admit that our company is not held responsible for.

2. Fare-Paying Repair Period after Production Discontinued

- (1) The period our company may accept product replacement with charge shall be seven (7) years after production of the product is discontinued.

Production stoppage shall be announced in the technical news, etc. of our company.
- (2) The product (including spare) cannot be supplied after production is discontinued.

3. Exemption of Compensation Liability for Opportunity Loss, Secondary Loss, etc.

Our company shall not be liable to compensate for any loss arising from events not attributable to our company, opportunity loss and lost earning of the customer due to failure of the product, and loss, secondary loss, accident compensation, damage to other products besides our products and other operations caused by a special reason regardless of our company's predictability in both within and beyond the gratis warranty period.

4. Change of Product Specifications

Please be advised in advance that the specifications described in catalogs, manuals or technical materials are subject to change without notice.

5. Application of Products

- (1) For use of our general-purpose sequencer MELSEC-Q series and Energy Measuring Unit QE81WH, they shall be used for a purpose which shall not lead to a material accident even when a failure or malfunction of the sequencer occurs, and a backup or fail-safe function shall be implemented systematically at external of the device in the event of a failure or malfunction.
- (2) Our general-purpose sequencers are designed and manufactured as general-purpose products which are targeted for general industry applications. Therefore, use of the sequencer for purposes in nuclear power plants and other power plants of each electric power company which greatly affect public, or for purposes in each JR company and the Defense Agency requiring a special quality assurance system shall be excluded from its applications.

However, the sequencer may be used for such purposes if the customer acknowledges that it should be used for limited purpose only and agrees not to require special quality.

Also, if you are considering to use this device for purposes that are expected to greatly affect human life or property and require high reliability especially in safety or control system such as aviation, medical care, railroad, combustion/fuel device, manned carrier device, entertainment machine, safety equipment, please consult with our service representative to exchange necessary specifications.

= End of page =

Customer Service

Please contact us at the following locations.

1 - 8 Midori-cho, Fukuyama-shi, Hiroshima, 720 - 8647, Japan Phone (084) 926 - 8142

When exported from Japan, this manual dose not require application to the Ministry of Economy, Trade and Industry for service transaction permission.

Specifications subject to change without notice.