

# CARBON NEUTRAL SOLUTIONS

*e-Factory*

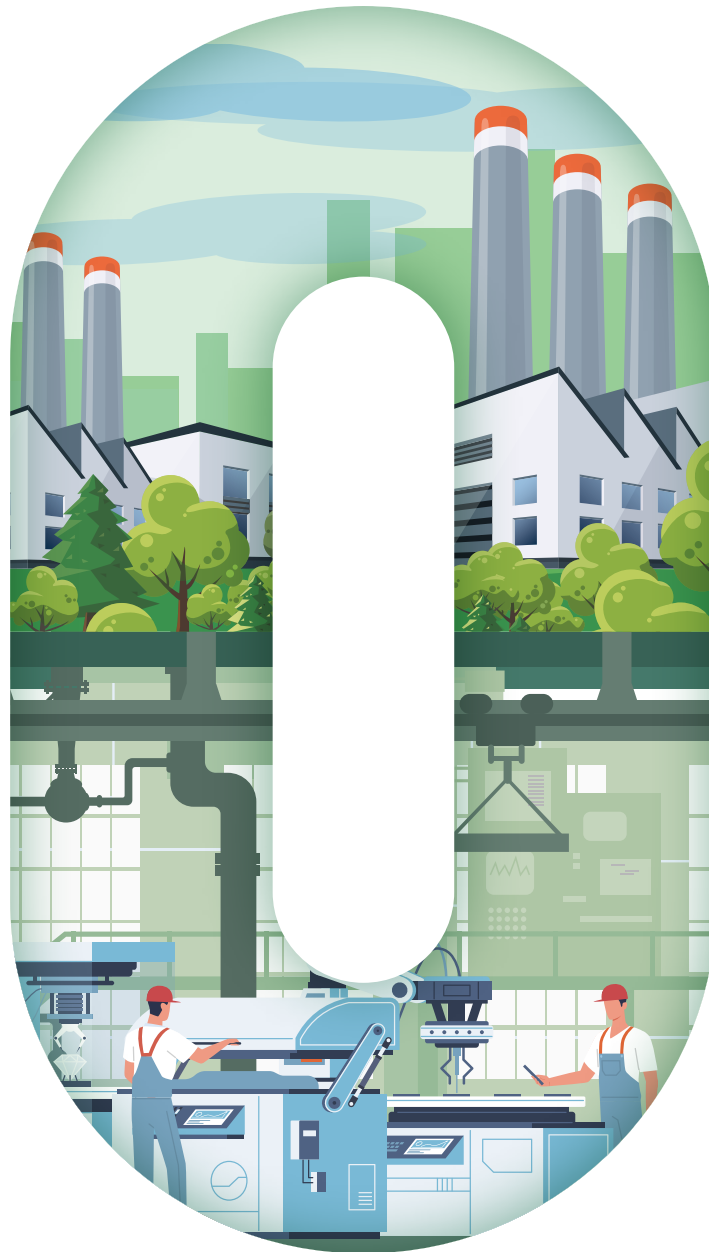

**Toward Manufacturing in a Decarbonized Society**

# GLOBAL IMPACT OF MITSUBISHI ELECTRIC



Through Mitsubishi Electric's vision, "Changes for the Better" are possible for a brighter future.

## *Changes for the Better*

"Changes for the Better" represents the Mitsubishi Electric Group's attitude to "always strive to achieve something better", as we continue to change and grow. Each one of us shares a strong will and passion to continuously aim for change, reinforcing our commitment to creating "an even better tomorrow".

Mitsubishi Electric is involved in many areas including the following:

### **Energy and Electric Systems**

A wide range of power and electrical products from generators to large-scale displays.

### **Electronic Devices**

A wide portfolio of cutting-edge semiconductor devices for systems and products.

### **Home Appliance**

Dependable consumer products like air conditioners and home entertainment systems.

### **Information and Communication Systems**

Commercial and consumer-centric equipment, products and systems.

### **Industrial Automation Systems**

Maximizing productivity and efficiency with cutting-edge automation technology.

Our advances in AI and IoT are adding new value to society in diverse areas from automation to information systems. The creation of game-changing solutions is helping to transform the world, which is why we are honored to be recognized in the 2019 "Forbes Digital 100" as one of world's most influential digital corporations.



FA-IT Integrated Solution



The “e-F@ctory” FA-IT integrated solution proposes ways of utilizing FA and IT technologies that reduce the total cost of development, production, and maintenance activities, continuously support customer kaizen activities, and promote monozukuri that is one step ahead.

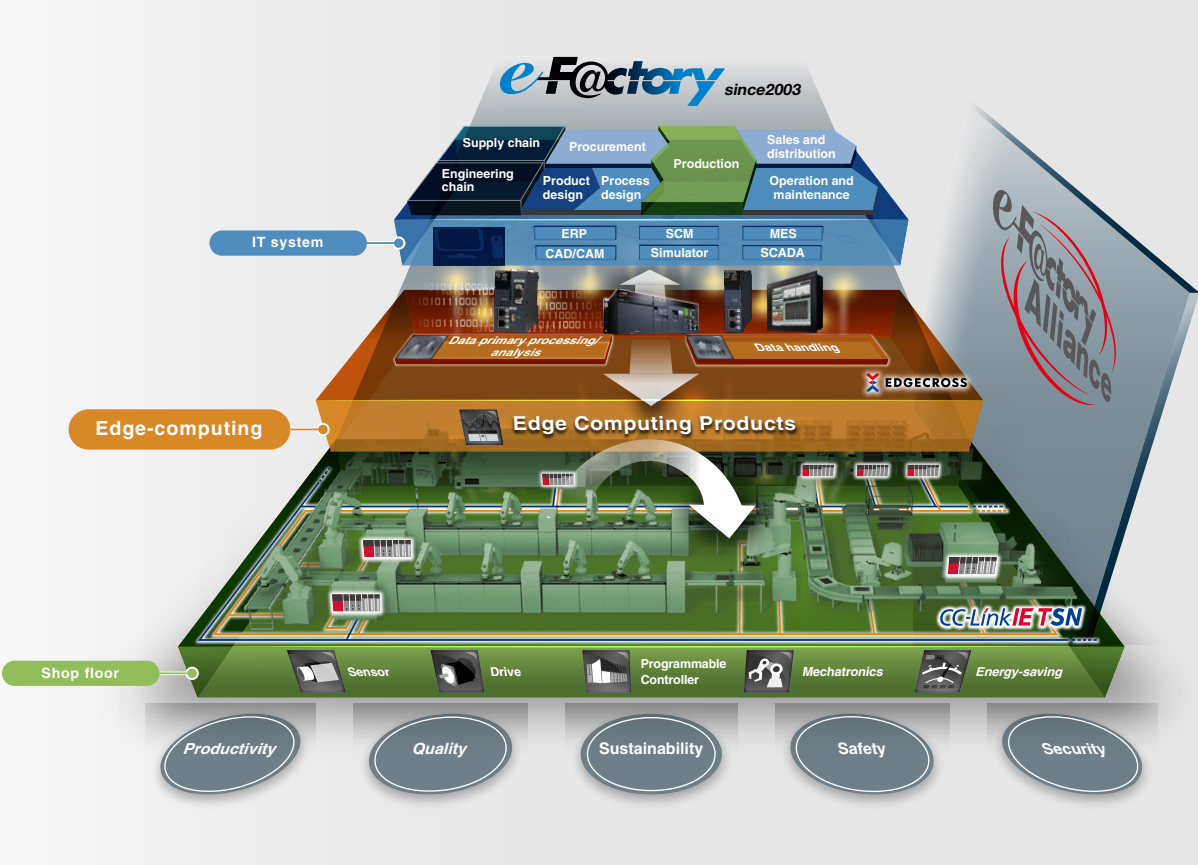

# INDEX

Carbon Neutral Solutions .....04

Problem Solving .....08

Products and Solutions .....14

# Aiming for a decarbonized society

## Introduction of renewable energy

By voluntarily introducing equipment to create renewable energy, such as solar power, as well as purchasing renewable energy, manufacturers will replace the CO<sub>2</sub> we emit with renewable energy and contribute to CO<sub>2</sub> reduction.

It is also crucial to use renewable energy without waste by optimizing power interchange and storage battery operation between sites.

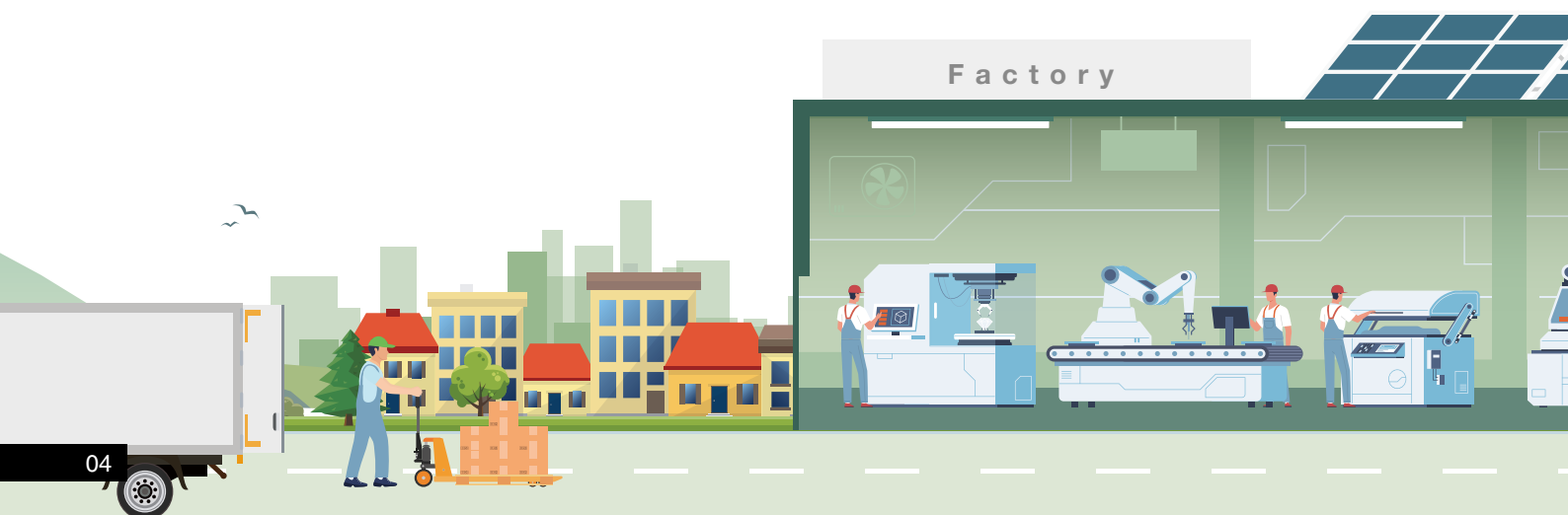
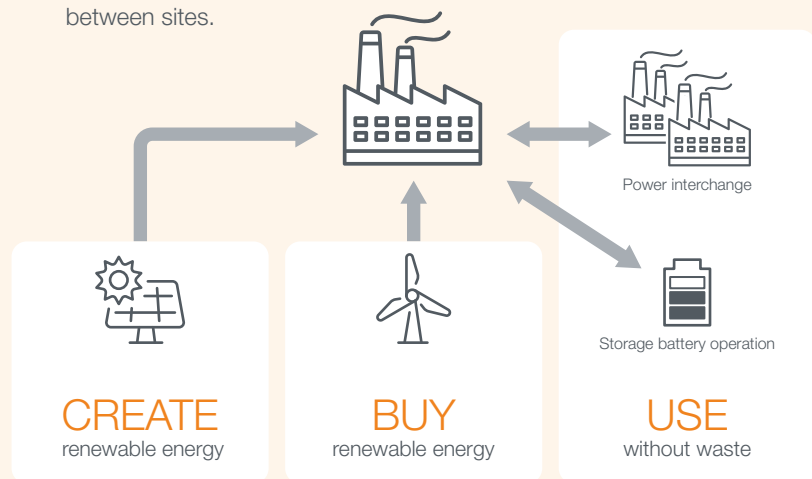



As a leading manufacturer, Mitsubishi Electric considers contributing to carbon neutrality our major mission. In addition to FA equipment and power distribution control equipment, we support our customers' sustainable business activities by utilizing IoT platforms as well as applications for visualization, analysis, and diagnosis.

## Achieving carbon neutrality (Net-zero CO<sub>2</sub> emissions)

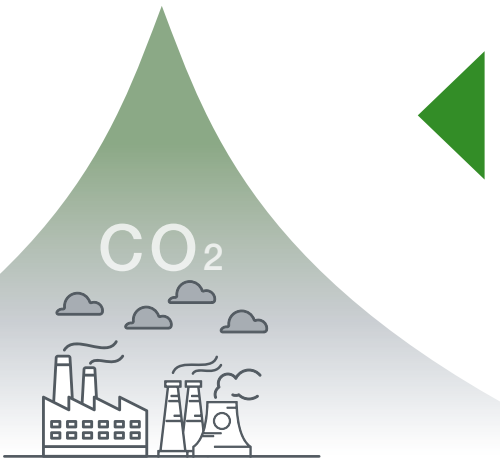

### Promotion of energy saving

We will reduce energy consumption and CO<sub>2</sub> emissions by introducing high-efficiency equipment and improving its operation in order to maximize energy efficiency.

In addition, reducing energy consumption can help cover the increased costs of purchasing relatively expensive renewable energy.

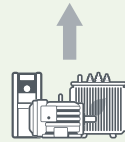
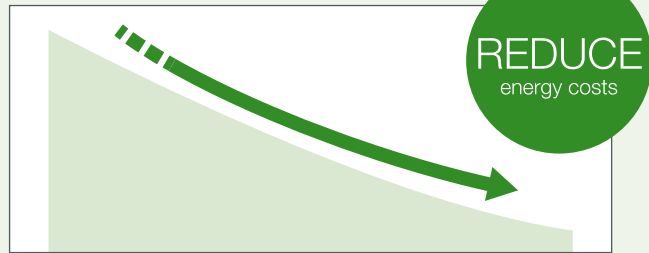

Introduction of high-efficiency equipment



Operational improvements

In this catalog, we propose solutions to reduce both CO<sub>2</sub> emissions and energy costs by promoting energy saving.





## Mitsubishi Electric Carbon Neutral Solutions

Mitsubishi Electric provides carbon neutral solutions by not only offering equipment that efficiently uses energy (our high-efficiency equipment product lineup), but also by supporting continuous improvement activities through data management (data collection, visualization, analysis, and diagnosis).

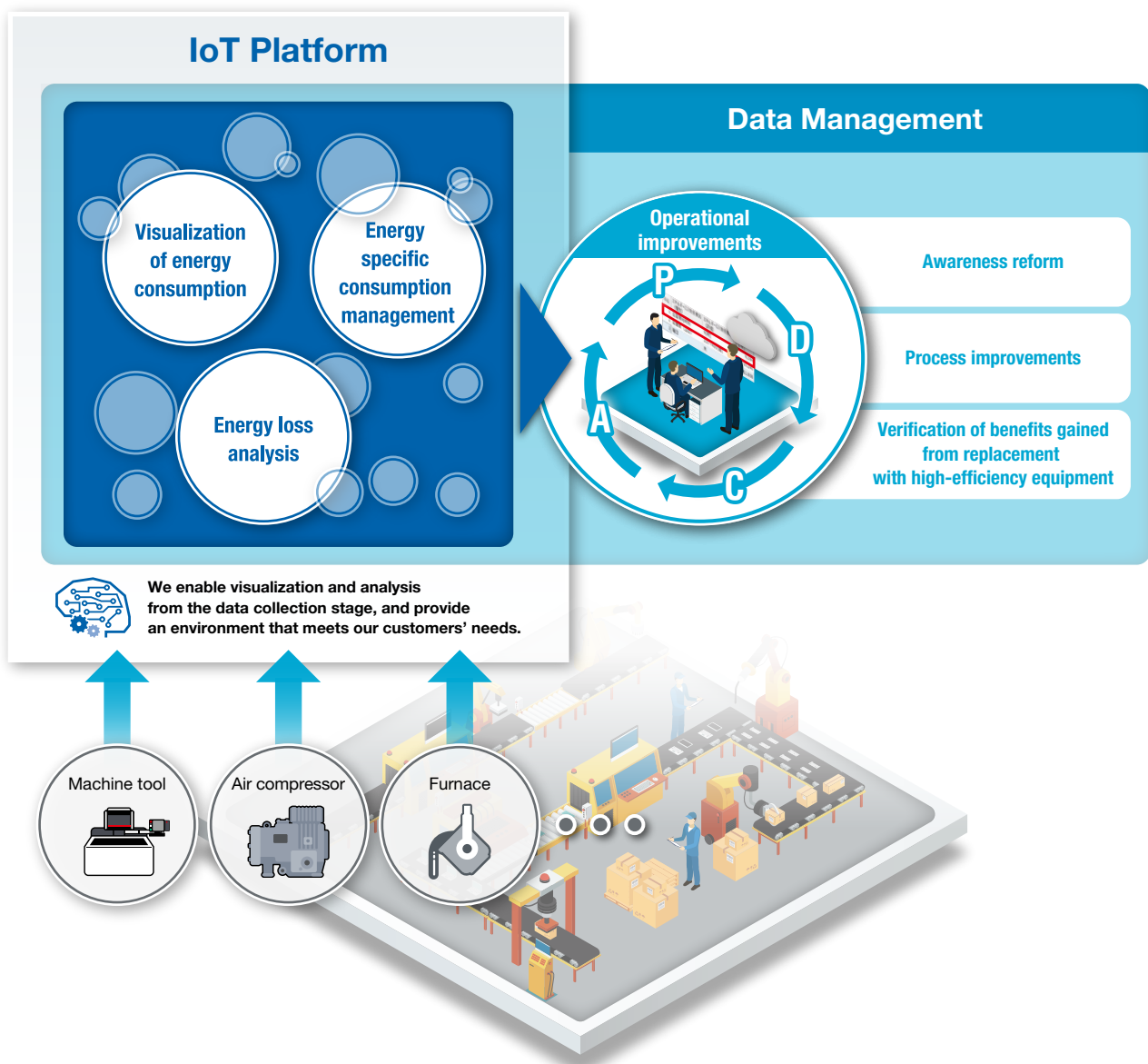

**Data Management** is indispensable for continuous reduction of CO<sub>2</sub> emissions.



## Operational improvements through data management contribute to the continuous reduction of CO<sub>2</sub> emissions.

Mitsubishi Electric provides a platform to collect and analyze all information related to energy and production.

Through the visualization, analysis, and diagnosis of the collected data, we support further operational improvements on our customers' production shop floors.

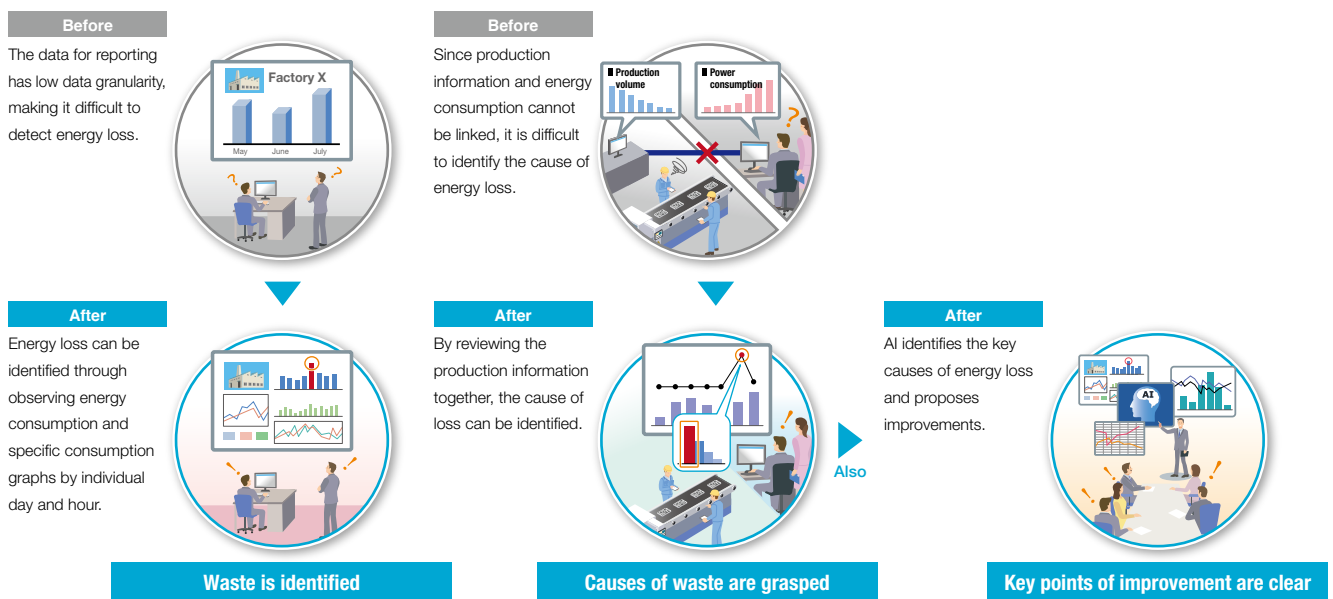

### CASE INDEX

CASE <b>1</b>	<p><b>Visualization</b> ▶ Buildings and Utility Equipment</p> <p>To automatically collect and manage CO<sub>2</sub> emissions from electricity, gas, and heavy oil</p> <p style="text-align: right;">P.08</p>	CASE <b>4</b>	<p><b>Visualization</b> <b>Analysis</b> <b>Diagnosis</b> ▶ Production Lines and Equipment</p> <p>To analyze the energy loss of production facilities and reduce CO<sub>2</sub> emissions</p> <p style="text-align: right;">P.11</p>
CASE <b>2</b>	<p><b>Visualization</b> <b>Analysis</b> ▶ Buildings and Utility Equipment</p> <p>To reform employee awareness of energy saving by disclosing energy information internally</p> <p style="text-align: right;">P.09</p>	CASE <b>5</b>	<p><b>Visualization</b> <b>Analysis</b> ▶ Entire Factory</p> <p>To reduce CO<sub>2</sub> emissions throughout the company and aim to increase corporate value</p> <p style="text-align: right;">P.12</p>
CASE <b>3</b>	<p><b>Visualization</b> ▶ Production Lines and Equipment</p> <p>To grasp wasted energy consumption</p> <p style="text-align: right;">P.10</p>	CASE <b>6</b>	<p><b>Improvement</b> ▶ Buildings</p> <p>To eliminate temperature unevenness and achieve energy saving at the same time</p> <p style="text-align: right;">P.13</p>

CASE 1

To automatically collect and manage CO<sub>2</sub> emissions from electricity, gas, and heavy oil



The higher-ups are saying “Strengthen management to reduce CO<sub>2</sub> emissions!” but where should we begin?

Solution

- Measures the amount of electricity, gas, and heavy oil used in the factory with various measuring instruments
- Measured data is automatically collected by a special-purpose data collection server, and CO<sub>2</sub> emissions are checked on a special-purpose screen on a web browser

EcoWebServerIII, an Energy-saving Data Collection Server, provides a solution for CO<sub>2</sub> emissions management

Electrical equipments, such as switchboards and switchboards and low-voltage distribution boards, as well as gas and heavy oil consumed in boilers, etc., are measured.

The energy data collected by EcoWebServerIII is used in calculations with CO<sub>2</sub> conversion factors to manage CO<sub>2</sub> emissions.

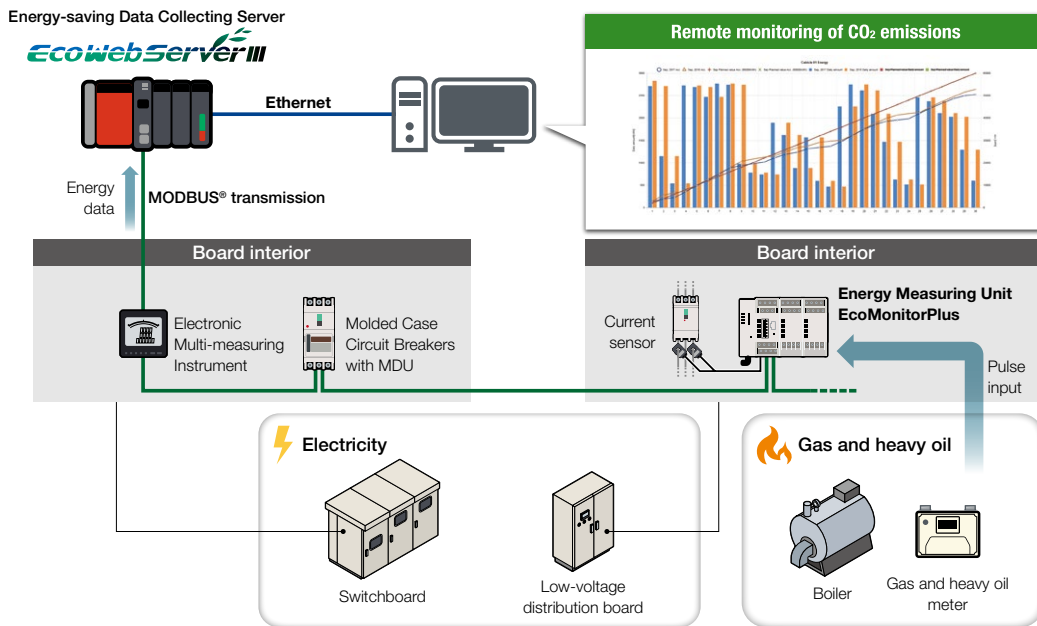

Benefits

- Energy management is centralized by measuring electricity with measuring instruments suited to the site and collecting the amount of gas, heavy oil, etc. consumed
- By automating data collection and CO<sub>2</sub> conversion, the amount of labor time required to aggregate energy and CO<sub>2</sub> emissions is reduced



Product and Solution Introduction

▶ Molded Case Circuit Breakers with MDU P. 14

▶ Energy-saving Data Collecting Server EcoWebServerIII P. 21

▶ Energy Measuring Unit EcoMonitor Series P. 15



Visualization

Analysis

Diagnosis

Improvement

Buildings and Utility Equipment

CASE 2

## To reform employee awareness of energy saving by disclosing energy information internally



In order to reduce CO<sub>2</sub> emissions, we would like all employees to have a higher awareness of energy saving. Is there a good way of doing this?

### Solution

- Review energy data and CO<sub>2</sub> emissions in an Energy Saving Software
- Easily create reporting materials for CO<sub>2</sub> emissions reduction activities using a dashboard screen

### EcoAdviser, an Energy Saving Support Software, provides a solution for energy data utilization

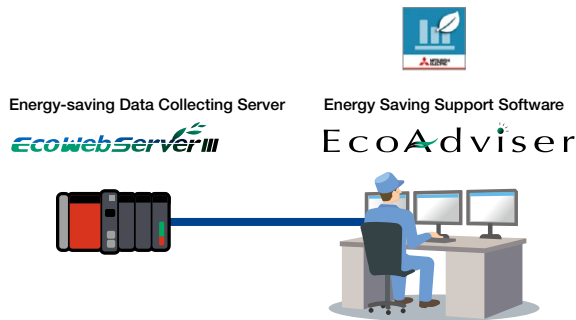

Reports that were previously created by data input and aggregation in Excel® are processed and pasted by the dashboard

▶ Aggregation in Excel®    ▶ EcoAdviser

Alleviates the burden of data aggregation and graph creation

**CO<sub>2</sub> emissions of entire factory and individual building**

Business operators and managers

**CO<sub>2</sub> emissions by individual department, line and product type**

Production shop floor

### Benefits

- Effectively supports employees' awareness of CO<sub>2</sub> emissions reduction and energy saving by preparing the dashboard with consideration to the people viewing it
- Reduces labor time for preparing materials such as internal reports on the results of CO<sub>2</sub> emissions reduction



### Product and Solution Introduction

▶ Energy-saving Data Collecting Server  
**EcoWebServerIII**

P. 21

▶ Energy Saving Support Software  
**EcoAdviser**

P. 22

CASE 3

To grasp wasted energy consumption



Even if we know how much our energy consumption is, we don't know whether energy is being consumed correctly according to fluctuations in production volume.

Solution

- By attaching an energy measuring module to a vacant slot of an existing programmable controller, energy data can be collected in addition to production data
- Free sample projects of the programmable controller and display device enable users to easily check production volume, electrical energy, and specific consumption

e-F@ctory Starter Package provides a solution for energy specific consumption management by individual process

Specific consumption management

This function calculates the intensity from the power consumption and number of production, and identifies improvements such as wasted power consumption of equipment.

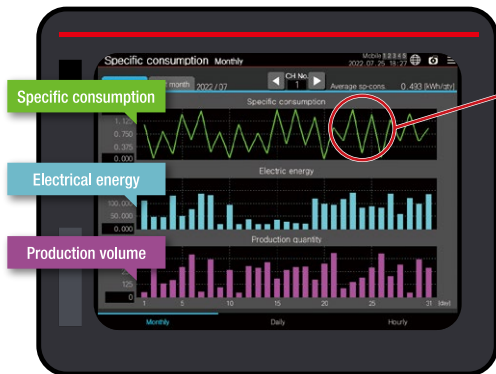

Can detect worsening of specific consumption in a glance  
(Example: Electrical energy is almost constant even though production volume is low)

Can identify areas for improvement

Reduce time spent on improvement activities

GOT2000

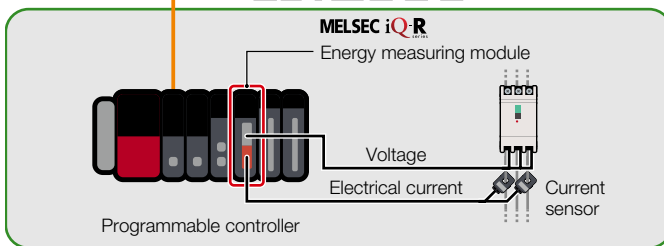

Benefits

- The module is attached to an empty slot of the programmable controller and can perform measurements with a small footprint and minimal installation work
- Enables management of energy specific consumption, thus contributing to improvement activities on the production shop floor



Product and Solution Introduction

▶ MELSEC iQ-R Series Energy Measuring Module	P. 15	▶ GOT2000 Series	P. 18
▶ MELSEC iQ-R/ iQ-F Series	P. 16	▶ e-F@ctory Starter Package	P. 19



Visualization

Analysis

Diagnosis

Improvement

Production Lines and Equipment

CASE 4

## To analyze the energy loss of production facilities and reduce CO<sub>2</sub> emissions



We want to reduce the amount of CO<sub>2</sub> emitted during production, but we don't even have time to check the data in the first place, so we don't know where the waste is.

### Solution

- AI automatically extracts energy loss for each device process and its associated causes
- Improvement activities are implemented based on diagnosis results of the automatically extracted loss factors

### EcoAdviser's AI function provides a solution for CO<sub>2</sub> emissions loss analysis and diagnosis

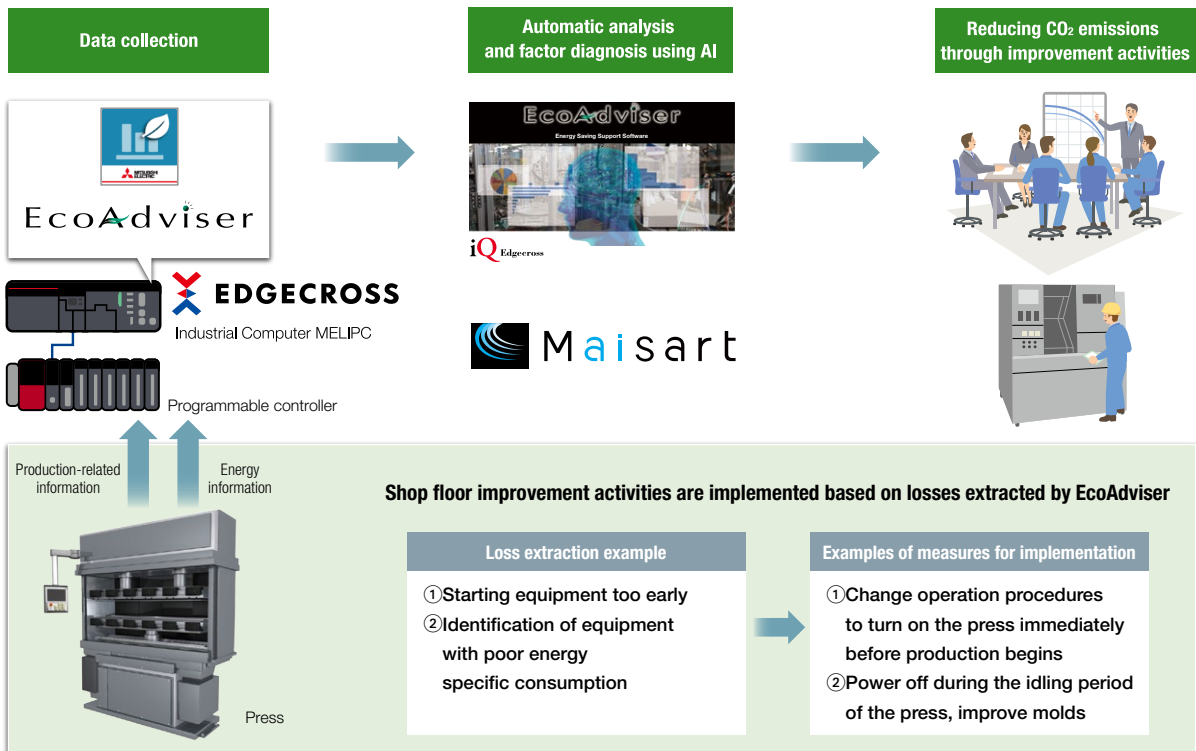

### Benefits

- Through automatic analysis, AI finds the waste hidden in production equipment difficult for humans to detect
- AI identifies loss factors then implements appropriate countermeasures, thus reducing labor time conventionally required for such tasks



### Product and Solution Introduction

▶ Industrial Computer MELIPC Series P. 20

▶ Open Platform Edgexross P. 30

▶ Energy Saving Support Software EcoAdviser P. 22

Visualization

Analysis

Diagnosis

Improvement

Entire Factory

CASE 5

## To reduce CO<sub>2</sub> emissions throughout the company and aim to increase corporate value



We want to reduce CO<sub>2</sub> emissions by checking information on energy waste at each site in real time, then implementing the necessary countermeasures

We want to identify the causes of energy loss on each production shop floor and use that information for improvement activities



### Solution

- Use cloud-based SCADA to perform batch monitoring of energy information and production information collected from each site

### Solution

- At each site, customers monitor and analyze various data on SCADA to identify causes of energy loss

### GENESIS64™ provides a solution for advanced monitoring and analysis

Centralized management of information from all sites

Occupancy rate of each site, energy consumption, etc.

Locations with high CO<sub>2</sub> emissions can be easily identified from AssetWorX's tree structure

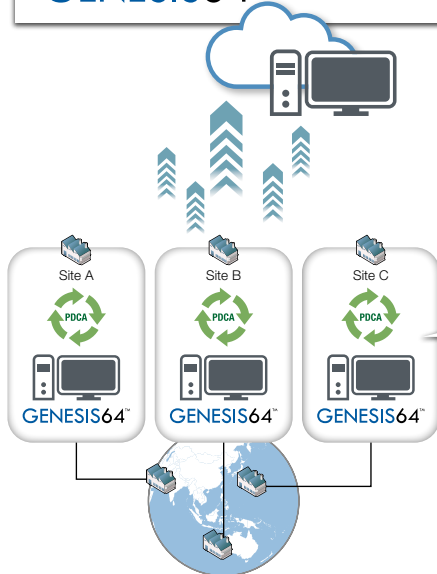

Feedback to each site

Analysis of energy loss factors at each site

GraphWorX, Energy AnalytiX, etc.

Identify factors on a Pareto chart

Improvement activities

### Benefits

- Monitor the energy information of each site, analyze the energy loss of each line throughout the company, and support improvement activities in factories



Product and Solution Introduction

▶ SCADA GENESIS64™

P. 24

Visualization

Analysis

Diagnosis

Improvement

Buildings

CASE 6

## To eliminate temperature unevenness and achieve energy saving at the same time

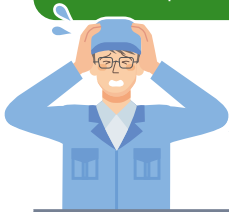

The building is large that the air conditioning isn't evenly distributed (Some areas are hot while some are cold). We want to save more energy, but we can't sacrifice comfort.

### Solution

- An air conditioner and Air Conducting Fan are used in combination to firmly circulate cold and warm air even in large spaces
- Achieving energy saving while maintaining comfort by increasing heating and cooling efficiency

### Circulation effect improves indoor temperature distribution

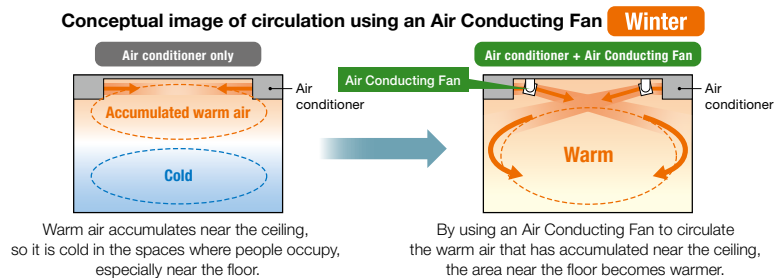

### Even if the setting temperature of the air conditioner is changed, it is possible to save energy and electricity effortlessly while maintaining comfort

#### Simulation of benefits\*1\*3 **Summer**

Temperature (comfort) simulation

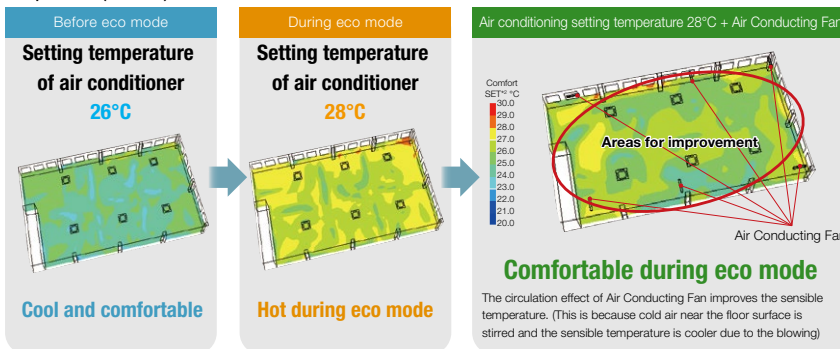

Energy-saving and cost-saving benefits

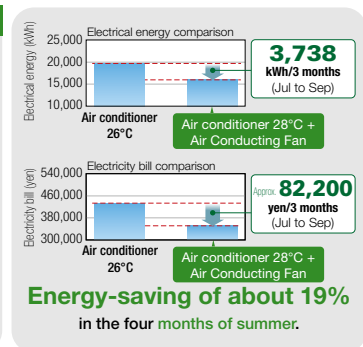

\*1 Simulation results are displayed using a general-purpose simulator.

\*2 SET (Standard Effective Temperature) is used. A temperature at which a person feels it is the same temperature as an environment with 50% relative humidity without airflow based on the air temperature, humidity, airflow, radiant heat, and clothing level.

Calculation conditions: Sedentary and office work/ clothing level: [Winter] Men, long-sleeved shirt + jacket + pants [Summer] Men, short-sleeved shirt + pants

\*3 This simulation is the case in Japan.

### Benefits

- Even in large spaces, air conditioning is distributed to every corner and the temperature environment is improved
- Reduce electricity bills with more conservative air conditioning temperatures while maintaining comfort



Product and Solution Introduction

▶ Air Conducting Fan

P. 28

## Installation example of energy measuring equipment

We have a lineup of measuring instruments according to the measurement location and application, allowing us to build the right measurement system for each customer.

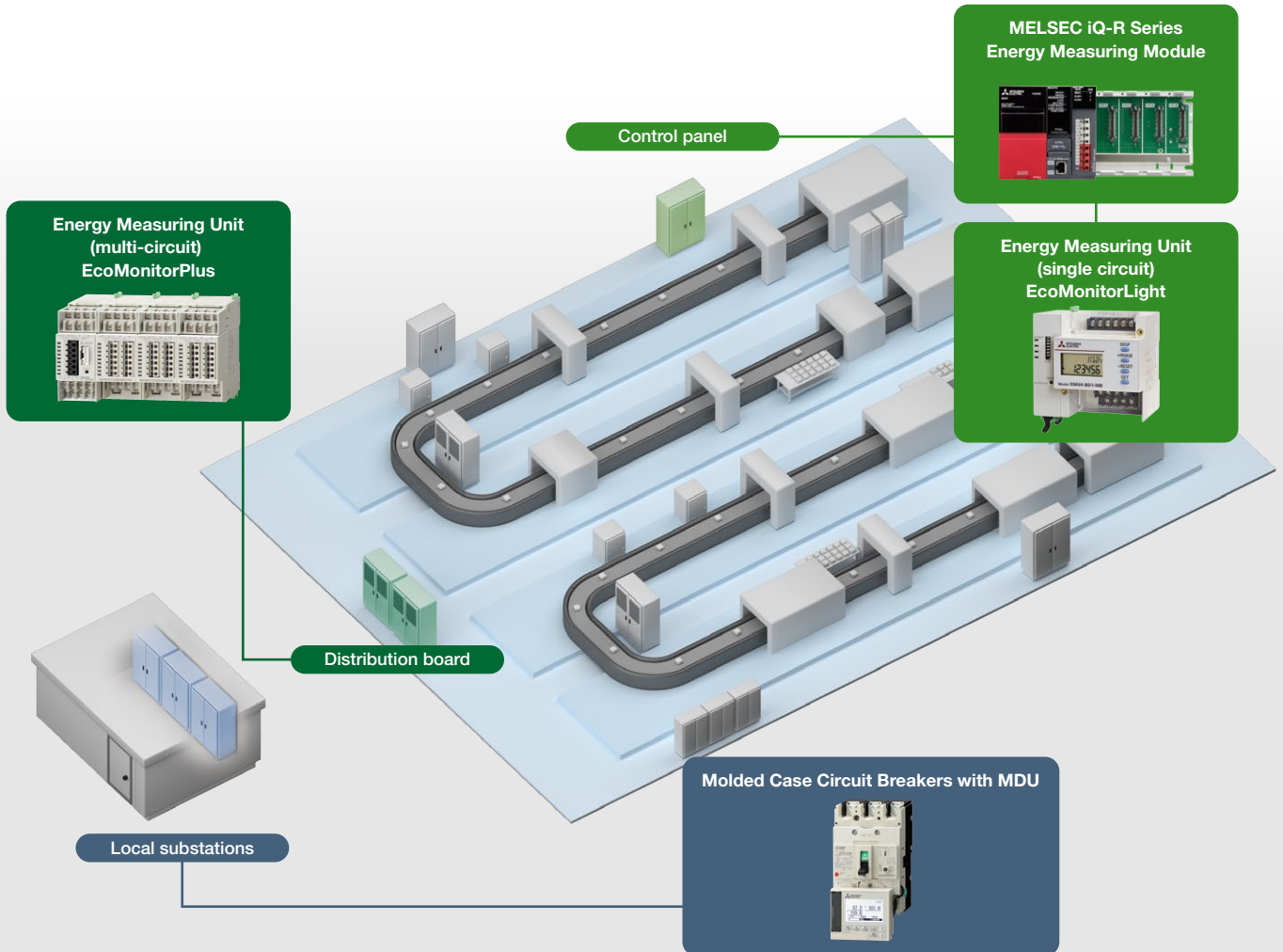

### Molded Case Circuit Breakers with MDU

A breaker that integrates a circuit breaker and a measurement display module and is also equipped with a communication function. The breaker has a built-in measurement function, VT, and CT to support energy measurement in a small footprint while saving on installation work and wiring.



## Energy Measuring Unit EcoMonitor Series

### EcoMonitorLight:

A compact single-circuit measurement device that can measure, display, set, and communicate energy all in one unit.

### EcoMonitorPlus:

An energy measuring unit that can be used in combination to expand circuits and communications. It can measure electrical energy, analog and pulse inputs, and leakages.



EcoMonitor Light

EcoMonitor Plus

### CO<sub>2</sub> conversion value display function

The computing function of the measurement terminal can calculate CO<sub>2</sub> emissions from the electrical energy.

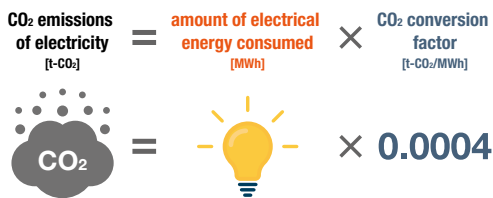

### Utilizes pulse input function to capture elements other than electricity

It is possible to obtain the elements (production volume) necessary for calculating energy other than electricity, such as gas and heavy oil, and the energy (specific consumption) required to produce one product.

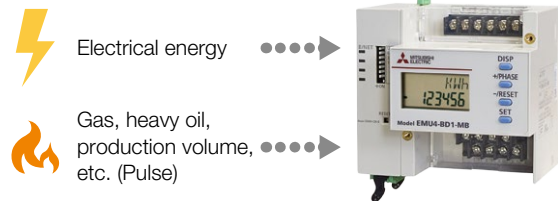

## MELSEC iQ-R Series Energy Measuring Module

Managing both energy amount and production data (production volume, non-defective volume, etc.) of the facility realizes specific energy consumption management according to model and process. By visualizing the points where specific energy consumption are deteriorating, problems at production site can be detected in real time, allowing operation improvement.

The energy consumption during production and non-production can be collected by turning on the measurement flag during production using the periodic electrical energy measurement function. Monitoring wasteful standby energy during non-production helps to realize energy saving.



### Detailed energy measurement by individual production line/process

#### Automotive manufacturing line

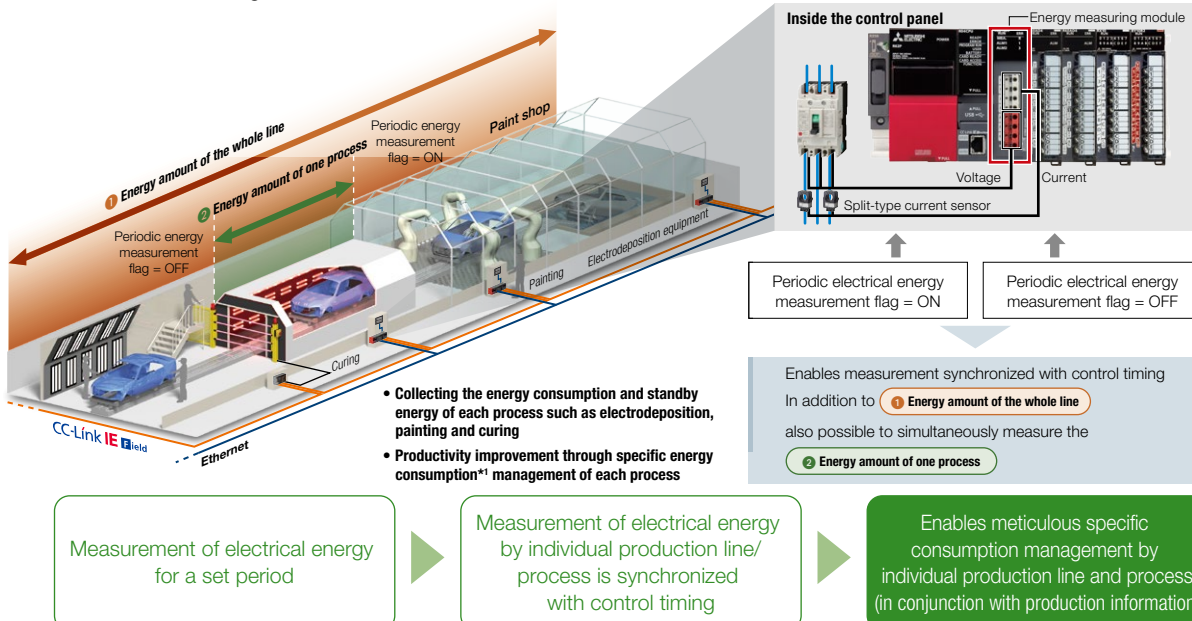

\*1 The specific energy consumption is a numerical value displayed by "dividing energy consumption by production volume," which is one type of index that measures energy productivity.



MELSEC iQ-R Series/ MELSEC iQ-F Series



MELSEC iQ-R series

MELSEC iQ-F series

A manufacturing plant is seldom stopped or taken offline and continuously produces the desired product or component. However, the control system occasionally requires maintenance; for example, at the time of a faulty product or system upgrade for manufacturing a new or updated component. At that time, thanks to the extensive maintenance functions embedded in the hardware and software, the user can trust the control system to handle transition into/out of the maintenance period for both preventive and post maintenance.

Based on the concept of “Easy, Convenient, and Excellent Cost Performance,” the MELSEC iQ-F Series contributes to customers’ operations with functions that are enhanced by IoT and maintenance functions that are useful for early recovery in the event of trouble.

From stand-alone use to system proposals including networks, we strongly support our customers’ “one-step-ahead manufacturing.”

CPU module



Device data transferring without programming with simple CPU communication function

- The programmable controller CPU module allows device data sharing by parameter registration with Mitsubishi Electric programmable controllers and third-party programmable controllers (simple CPU communication function)\*1
- Data collection is easier without changing programs of the existing programmable controllers.

\*1 For the list of connectable devices, please see the link below.  
<https://www.MitsubishiElectric.com/fa/ref/ref.html>

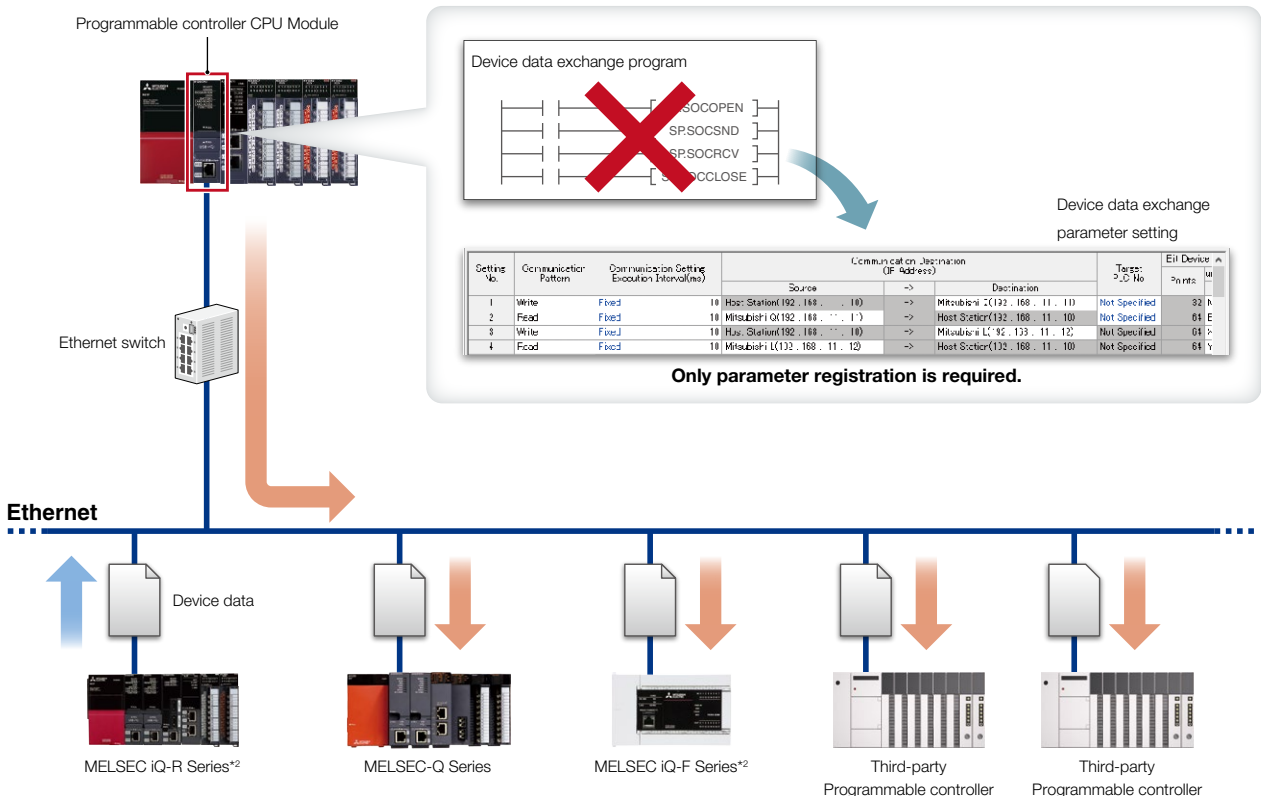

\*2 Supported by the embedded Ethernet port only.



## ■ OPC UA Module

iQ-R iQ-F

### An OPC UA server module makes it easy to build reliable systems

- Enables data exchange between multi-vendor products and across different operating systems, enabling secure and reliable data communication between manufacturing and host IT systems

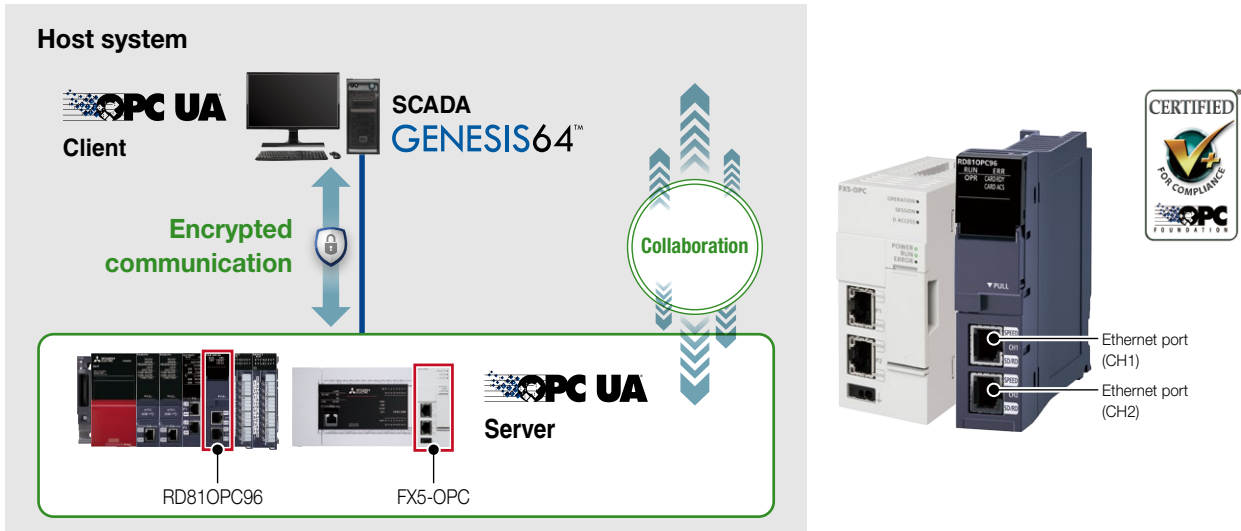

OPC Unified Architecture (UA):  
Platform independent service-oriented communication standard developed by the U.S. OPC Foundation

## ■ CPU module

iQ-R iQ-F

### Efficiently analyze equipment operation status and cause of problems

- Data can be collected at specified intervals (maximum speed of 1 ms) or at any time, and collected data can be saved as CSV files
- CSV files can be utilized to create various materials tailored to the specific purpose, such as daily reports, form creation, and reports.

#### ■ General data collection using computers and external connection devices (100ms)

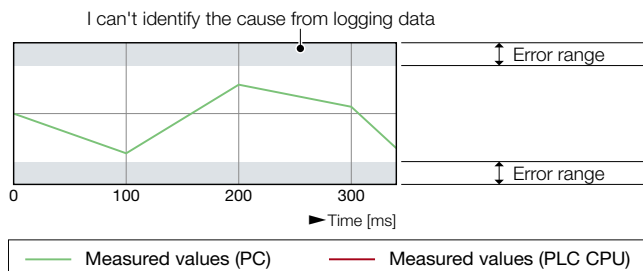

#### ■ Data collection with a CPU module (sequence scan synchronization: Max. speed of 1ms) Collecting data in milliseconds

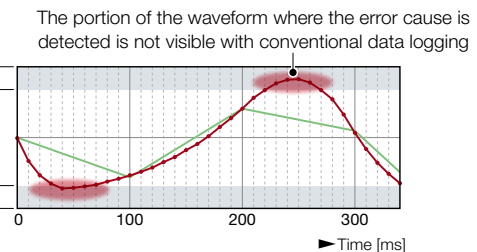

## ■ CPU module

iQ-R iQ-F

### Efficient diagnostics with extensive event logging

- Logging of program change events, errors and when the power is turned off
- Event logging displayed in list form
- Quickly detect problems due to operating mistakes by multiple users

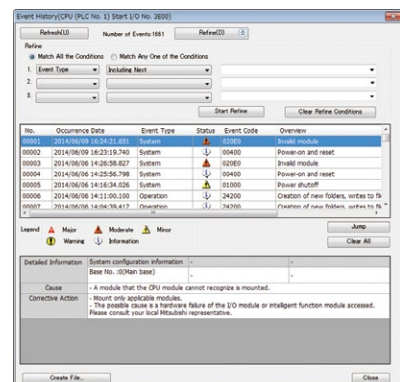

## GOT2000 Series

GOT stands for Graphic Operation Terminal. Switches and lamps had been conventionally attached to an operation panel as hardware. However, by using the screen design software, those can be created, and displayed and operated on the monitor screen of the GOT, the touch-panel HMI.



### Drive Control Interaction **GT27** **GT25** **GT23** **GT21** **GS21** **GT SoftGOT2000**



The GOT2000 provides advanced functionality and improves connectivity with Mitsubishi drive control equipment (servo, inverter, robot). It provides some functions such as parameter setting on the GOT screen.

The GOT Drive enhanced functionality is designed to eliminate need for additional hardware, software and suit customers' applications to speed up system startup, improve maintenance and troubleshooting. GOT screens (sample screens) of various interactive functions are available.

\* Depending on the GOT model, some equipment is not supported or there are function limitations.



### GT SoftGOT2000



GT SoftGOT2000 is the HMI software that runs on computers and panel computers, and has the same functions as the GOT2000 Series HMI.

Up to four channels of industrial devices can be monitored on a single module of GT SoftGOT2000 by using the multi-channel connection. Edgecross integration also makes it easy to visualize data collected and processed by Edgecross.

\* Supports Ethernet connection, OPC UA server connection, and multichannel connection only when connecting to a microcomputer.

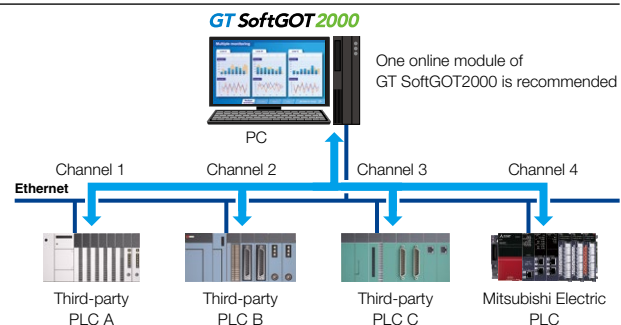

### GOT Mobile function **GT27**\*1 **GT25**\*1 **GT23** **GT21** **GS21** **GT SoftGOT2000**\*2



Use a web browser on tablets to check the equipment status from a remote location.

Multiple\*1\*2 information devices (clients) can simultaneously access GOT so that you can view and operate a different screen on each device.

#### Simultaneous monitoring on multiple\*1\*2 information devices

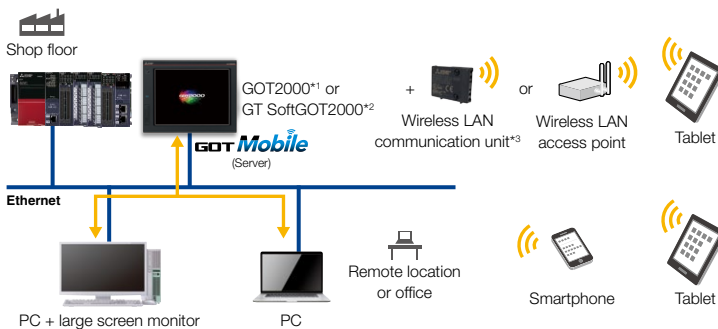

Check the status of the worksite using a web browser.



Outside of the clean room



From a remote location

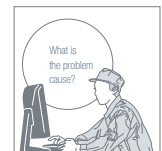

From your office

Other usage

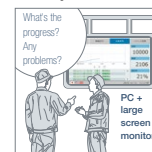

On a large screen



Simultaneous confirmation by multiple people



Monitor production with one PC

\*1 If the GOT Mobile server is GOT2000 (GT27, GT25), up to five information devices can monitor a single GOT simultaneously.

A separate GOT Mobile function license (GT25-WEBSKEY-□) for GOT2000 is required.

\*2 If the GOT Mobile server is GT SoftGOT2000, up to 15 information devices can monitor a single GT SoftGOT2000 module simultaneously.

A separate GOT Mobile function license (SGT2K-WEBSKEY-□) for GT SoftGOT2000 is required.

\*3 The wireless LAN communication unit cannot be used with GT2505, GT25 handy, or GT SoftGOT2000. A separate access point is required.

#### Safety Precautions

When using the remote control function, ensure the safety of the field site by being prepared to handle unexpected situations such as communication delays and interruptions.

## e-F@ctory Starter Package

The e-F@ctory starter package includes sample projects for the MELSEC iQ-R/iQ-F Series programmable controller and the GOT2000 Series human-machine interface. Programs for visualization and simple analysis are provided in sample project format, realizing IoT infrastructure on the shop floor just with basic settings such as device assignment and parameter registration. The starter package can help solve issues including consideration time and budget required for IoT system construction.



**e-F@ctory** Starter Package



**GX Works3 sample project for the MELSEC iQ-R/iQ-F Series**

**GX Works3 sample project for the GOT2000 Series**

**Instruction manual**

## Specific consumption control

iQ-R

This function calculates the intensity from the power consumption and number of production, and identifies improvements such as wasted power consumption of equipment.

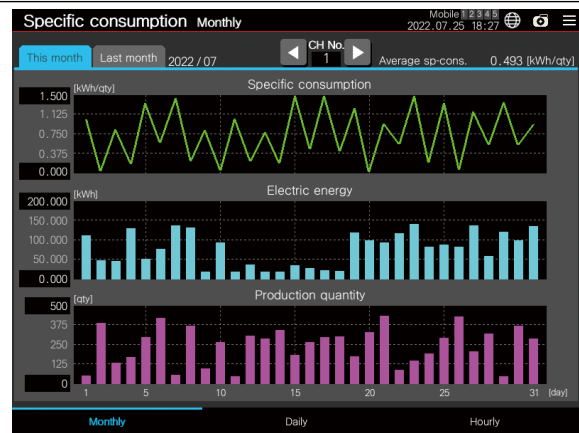

## Operational status monitor

iQ-R

This function visualizes the operation status (operation, stop, non-operation) of the equipment.

The data is displayed in a time-series graph, which enables real time monitoring of the equipment status.

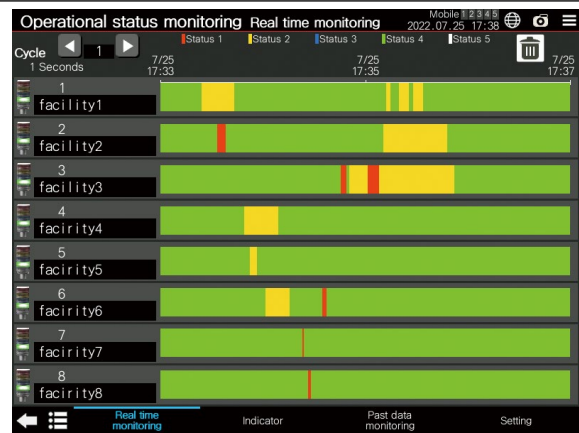

## Loss time analysis

iQ-R

This function analyzes the loss time due to top 16 losses or 7 losses, which reduce the production efficiency.

The rates of the non-operation time for each non-operation factor of the equipment are measured and displayed in a graph.

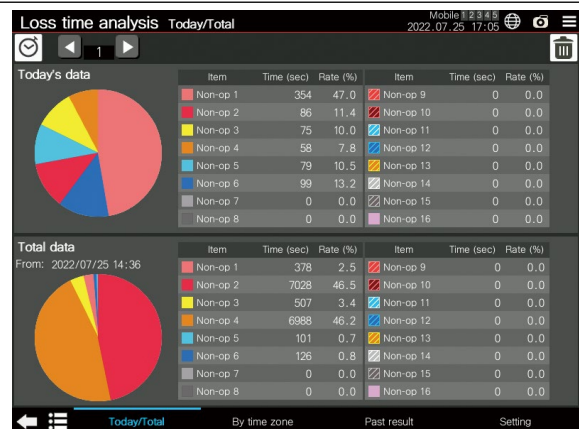

## Industrial Computer MELIPC Series

Mitsubishi Electric's industrial-use PC MELIPC Series makes it possible to build systems with edge computing utilizing IoT at a high degree of freedom due to its robust features specifically for FA use and adoption of general-purpose applications. The lineup consists of four product types to suit various data utilization scenarios depending on the application; from a high-end model supporting a high-performance processor and CC-Link IE field network capable of high-speed communication to a simple and compact lowrange model.



# MELIPC

### Pre-installed with Edgexcross – an open software platform suited to data utilization



Edgexcross\*1, a software platform in the edge computing domain, is preinstalled, therefore through combination with Edgexcross-compatible software,

it supports preventive maintenance and building of systems for quality improvement, etc. by utilizing shop floor data.

\*1 An open software platform provided by the Edgexcross Consortium, a general incorporated association.  
<https://www.edgexcross.org/en/solution/feature.html>

### MI5000

#### One unit can process production information and control equipment in real-time

By operating VxWorks®, a real-time OS, in addition to Windows®, device control and information processing functions are consolidated into one unit, thus contributing to reduced system build costs and space-saving. Moreover, control and production information of equipment connected via CC-Link IE field network are communicated at a maximum speed of 1ms, realizing high-precision device control and high-speed collection of production information.

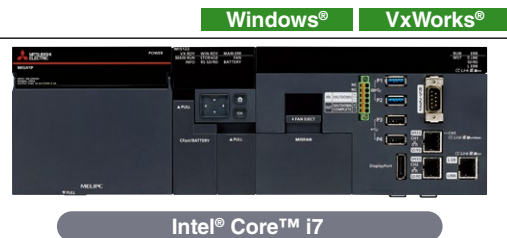

### MI3000

#### Panel computers equipped with integrated high resolution touch screens

Large screen and high resolution LCD panel is equipped as standard for data display and touch operation. Light-touch operation is realized with a PCAP touch panel that is widely used for smartphones and tablet devices. The touch panel with high transmittance offers clear and high visibility display. In addition, GT SoftGOT2000 is preinstalled\*2 to easily achieve monitoring equivalent to the GOT2000 Series.

\*2 Does not require a separately-sold license key for GT SoftGOT2000 (for USB port).



### MI2000

#### Realizing optimal IoT for the production shop floor by expanding various systems

Intel® Core™ i3



Intel® Core™ i3 is adopted as the CPU, and performs not only data collection, but also simple analysis, diagnosis, and monitoring of collected data to contribute to quality improvement. It also features a 2.5" HDD/SSD slot\*3 and a PCI Express®/PCI slot\*4 to accumulate large amounts of data and expand functionality.

\*3 2.5" HDD/SSD slots are available on MI2000 only.

\*4 MI3000 is PCI Express® only.

### MI1000

#### Links with existing equipment to realize low-cost IoT integration on the production shop floor

Intel® ATOM™



The energy saving Intel® Atom™ E3826 is adopted and enables computer functions in a compact size of 26 mm in height. It is space-saving and can easily be expanded to existing facilities, contributing to IoT support for customer facilities.

## Energy-saving Data Collecting Server EcoWebServerIII

EcoWebServerIII is a "simple, convenient, and compact" data collection server that collects and stores data from measurement equipment with communication functions, as well as visualization in graph format on a web browser. One EcoWebServerIII can perform both demand management and energy consumption management.

In addition, by data input/output with a MELSEC programmable controller, a separate file transfer server and mail server, this product is equipped with functions that realize automatic transfer of measurement data (CSV format), mail notification, and more.



# EcoWebServerIII

### Web server function

The collected data can be transmitted to the intranet via Ethernet, then current values and graphs of the measurement data can be checked on a web browser. Because it is a standardized packaged product, there is no need to build in a screen, therefore engineering labor time can be greatly reduced.

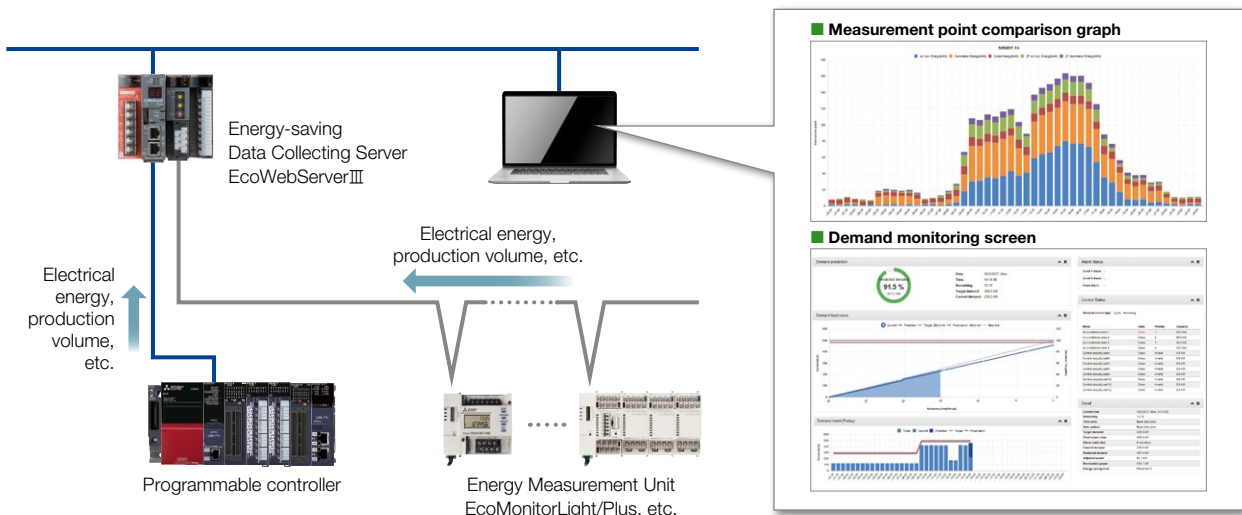

### Easy setting function

All users need to do is register which elements to collect with which measuring instrument, then energy data will be collected and graphed.

Even if the number of measurement points or names change due to expansion, updating, layout change, etc. of equipment, it is possible to change the settings by following simple steps as long as the user has a computer, configuration software, and the product itself.

#### Register measurement terminal

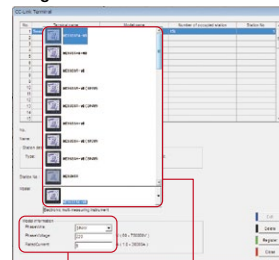

Select model information    Select terminal to be used

#### Register measurement point

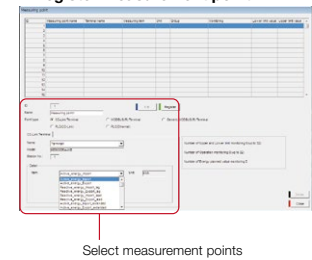



Select measurement points

### Management of CO<sub>2</sub> emissions

**EcoWebServerIII**    **EcoAdviser**

CO<sub>2</sub> measurement data can be calculated by multiplying the collected electrical energy data by CO<sub>2</sub> conversion factor.

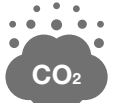
$$\text{CO}_2 \text{ emissions of electricity [t-CO}_2\text{]} = \text{amount of electrical energy consumed [MWh]} \times \text{CO}_2 \text{ conversion factor [t-CO}_2\text{/MWh]}$$

 =  × 0.0004

### Specific consumption management function

**EcoWebServerIII**    **EcoAdviser**

The energy (specific consumption) required to produce one product can be calculated from the data collected on electrical energy and production volume.



## Energy Saving Support Software EcoAdviser

EcoAdviser can create graph dashboards based on energy data collected from EcoWebServerIII and Edgexcross. It can also calculate CO<sub>2</sub> emissions and specific consumption based on energy data.

The AI diagnostic version is equipped with Mitsubishi Electric's AI technology Maisart, which supports energy saving activities through automatic analysis of energy loss, factor diagnosis, and calculation of countermeasure effects.

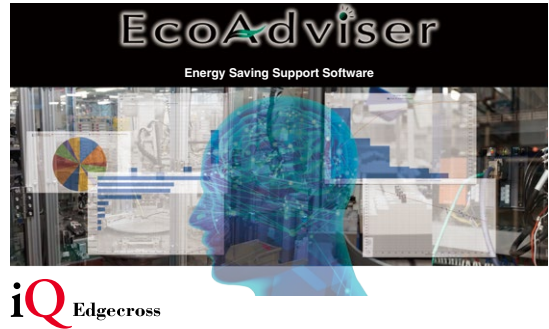

### Graphing function

With its built-in graphing function, EcoAdviser can create graphs according to the contents users want to analyze. **Common EcoAdviser features**

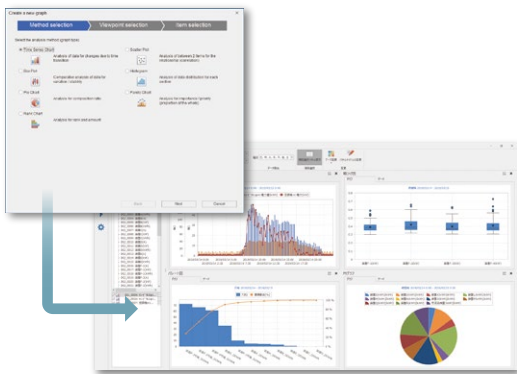

#### Available graphs (7 types)

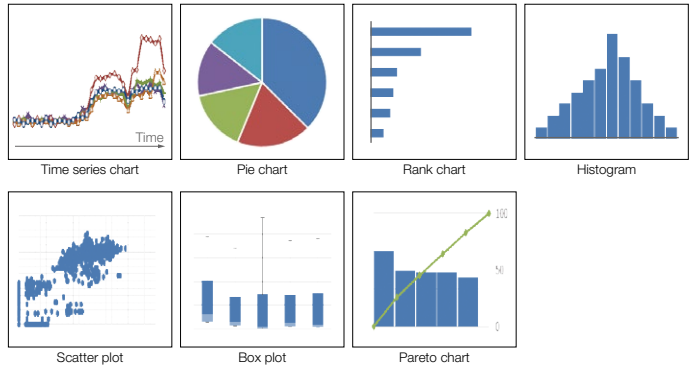

### Management of CO<sub>2</sub> emissions

CO<sub>2</sub> measurement data can be calculated by multiplying the collected electrical energy data by CO<sub>2</sub> conversion factor.

$$\text{CO}_2 \text{ emissions of electricity [t-CO}_2\text{]} = \text{amount of electrical energy consumed [MWh]} \times \text{CO}_2 \text{ conversion factor [t-CO}_2\text{/MWh]}$$

$$\text{CO}_2 = \text{Lightbulb} \times 0.0004$$

### Specific consumption management function

The energy (specific consumption) required to produce one product can be calculated from the data collected on electrical energy and production volume.

In addition, it is possible to register specific consumptions by hour, and even if a wide variety of products are produced on the same line, the specific consumption for each model type can be calculated.

### Visualization of CO<sub>2</sub> emissions and raising employee awareness (dashboard function)

EcoAdviser enables analysis and visualization of CO<sub>2</sub> emissions and energy consumption.

#### Benefits

- Saves labor required to prepare reports via the conventional method of aggregation in Excel®
- Educational benefits such as raising awareness of initiatives at the workplace level through visualization

**NEW**

Specialized consultants assist users with the creation of dashboards to offer services that support the effective utilization of measurement data and promote activities.

#### Recommended for the below needs

- Want to display CO<sub>2</sub> emissions and energy consumption and use it for educational activities and internal materials, but can't properly visualize the screen that would be most appropriate
- Want to display and use the screen effectively, but can't devote time to creating it







## Automatic analysis function to reduce energy loss in production equipment

Mitsubishi Electric's unique know-how can automatically extract energy losses from production equipment in accordance with the five major perspectives of energy saving.

AI diagnosis edition

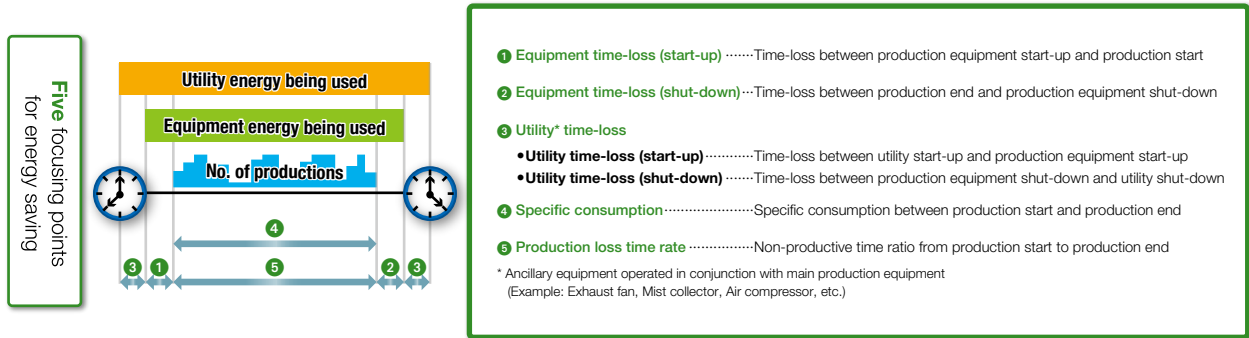

## Energy-losses identification, Factor diagnosis function, countermeasure effect verification function

### Losses identification screen

plot	Date	1 Equipment time-loss (start-up)		3-1 Utility time-loss (start-up)		3-2 Utility time-loss (shut-down)		4) Specific consumption kWh/個	5) Production loss time rate %
		(1)Equipment time-loss (start-up) [Minutes]	(2)Equipment time-loss (shut-down) [Minutes]	(3-1)Utility time-loss (start-up) [Minutes]	(3-2)Utility time-loss (shut-down) [Minutes]	(3-1)Utility time-loss (start-up) [Minutes]	(3-2)Utility time-loss (shut-down) [Minutes]		
	3/22/2020								
	3/23/2020	10	2	42	313	12	76	0.31818	41
	3/24/2020	18	4	53	794	58	568	0.22494	16
	3/25/2020	8	13	52	683	2	229	0.27543	24
	3/26/2020	10	13	58	568			0.22241	22
	3/27/2020	22	2	52	683			0.23048	19
	3/28/2020								
	3/29/2020								
	3/30/2020	15	3					0.19284	12

### Factor diagnosis screen

Energy-loss factor diagnosis

Diagnosis period: 3/1/2020 - 4/30/2020  
Equipment name: Line 2 of printed board manufa  
Energy saving points: (1)Equipment time-loss (start-up)

Rank	Energy-loss factor (type)	Energy-loss factor (detail)	Expected improved result(\$/Year)	Does this information help you?
1	Manufacturing starting time	9[Time]	7	<input type="radio"/> Yes <input type="radio"/> No
2	Production volume	339-410	12	<input type="radio"/> Yes <input type="radio"/> No
3	Day of the week	Thursday	14	<input type="radio"/> Yes <input type="radio"/> No
4	Production volume (the prev...)	220-440	8	<input type="radio"/> Yes <input type="radio"/> No
5	Equipment start-up time	4[Time]	6	<input type="radio"/> Yes <input type="radio"/> No

Apply evaluation

● Improvement advice  
● Evaluation of diagnostic results  
Reflects user's evaluations in subsequent diagnostic results

### Effect verification screen

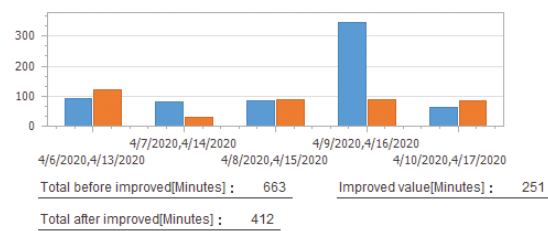

Effects of power consumption improvements

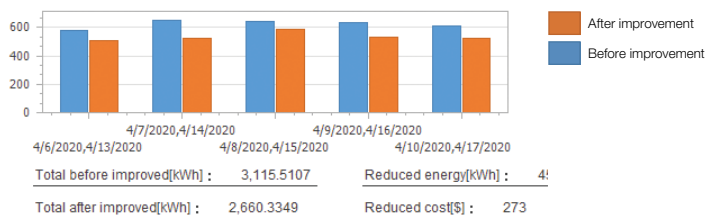

Effects of improvements from five focusing points for energy saving

## Automatic extraction function for energy loss during standby and breaks

The AI analysis function makes it possible to automatically extract electrical energy used during standby and breaks by individual day based on the data related to electrical energy consumed by utilities other than production facilities.

## What is Mitsubishi Electric AI technology, Maisart?

An abbreviation of "Mitsubishi Electric's AI creates the State-of-the-ART in technology," "Maisart" is Mitsubishi Electric's AI technology brand, and it embodies the concept of making everything smart by leveraging our unique AI technology.



## SCADA GENESIS64™

This cutting-edge software delivers real-time visualization, mobility, analytics, and connectivity to deliver a contextualized view of enterprise operations for manufacturing, industrial automation, and smart buildings customers.



iQ Edgecross

GENESIS64™

### Energy AnalytiX®

Energy AnalytiX® provides real-time data collection and visualization of energy consumption such as electric, gas, and other utilities. It enables the calculation of specific CO<sub>2</sub> emissions data and other energy metrics at any level of your organizational hierarchy, making it easy to uncover energy efficiency offenders and reduce overall energy costs.

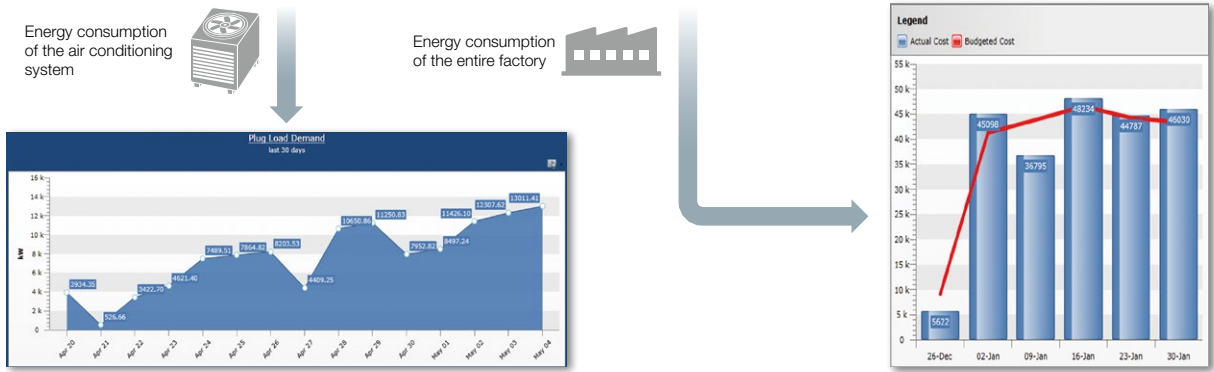
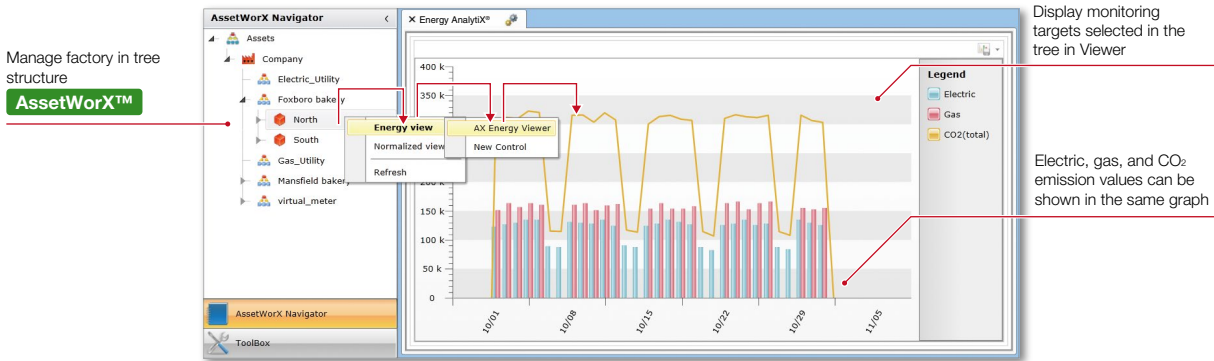





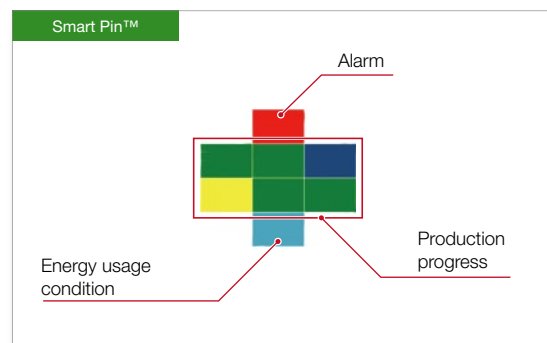

### EarthWorX™

EarthWorX™, a geographic information system (GIS) mapping module, provides visualization for widely dispersed assets. Create a geographical overview to monitor multiple locations while maintaining the ability to locate and drill into specific assets. Smart Pin™ enables the status of many assets to be easily understood at a glance. Users can integrate with Google Maps™, Bing® Maps, and Esri™ to include additional GIS mapping features and data layers.



## High-efficiency equipment lineup achieving energy saving in factories

Mitsubishi Electric is rolling out various high-efficiency equipment related to manufacturing in order to realize energy saving at its factories.

Inverter FREQROL Series	MELSERVO-J5 Series
 <p><b>FR-F800/F700PJ</b> Energy-saving with an inverter Compatible with IE4 high-efficiency IPM motor drive</p>	 <p><b>Rotary servo motor HK Series</b> Increased motor efficiency due to high power density design</p>
 <p><b>FR-E800</b> Compatible with IE5 global PM motor EM-A drive</p>	 <p><b>Simple Converter MR-CM Drive Unit (Converter Separate Type) MR-J5D-G4</b> Effective utilization of line power through common busbar connections</p>
 <p><b>FR-D700-G</b> Mitsubishi Electric's S-PM geared motor proposes stable speed control and energy-saving via sensor-free control</p>	 <p><b>Multi-axis Servo Amplifier MR-J5W</b> Multi-axis unit achieves energy saving, miniaturization, and cost reduction of equipment</p>

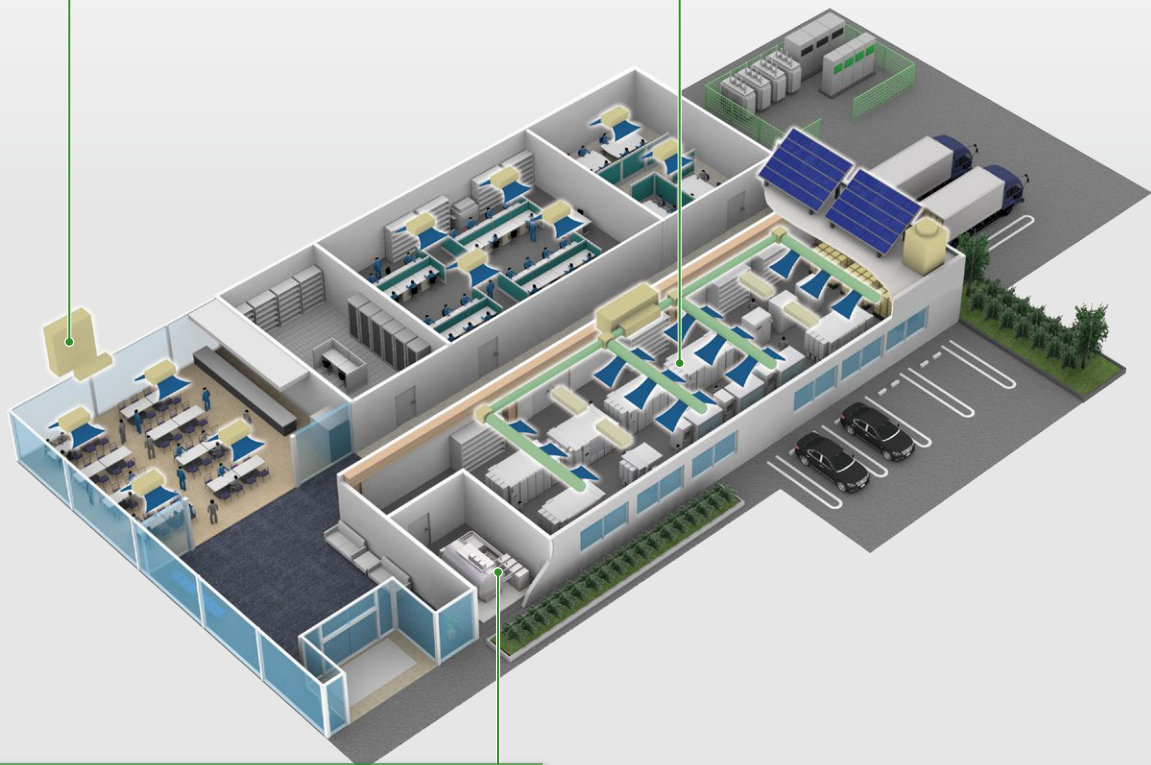

 <p><b>Top Runner Motor SF-PR</b> Compatible with premium efficiency IE3 Reduces loss by <b>40 to 50%</b> * Comparison with our standard efficiency motor (Super Line series SF-JR type) * Emissions are reduced by 20 to 30% relative to our high-efficiency motors (Super Line Eco Series SF-HR type)</p>
 <p><b>Synchronous Reluctance Motor SynRM</b> <span style="border: 1px solid red; padding: 2px;">Coming soon</span> Exceeds current Top Runner motor (SF-PR) <b>Achieves IE5 efficiency class</b> Reduces loss by <b>20 to 30%</b> * Inverter drive only, efficiency reference value: IEC/TS 60034-30-2</p>

## Inverter FREQROL Series

Supports the drive of IE5 global PM motor EM-A and contributes to energy saving on customers' production shop floors.



### Improved energy saving by drive with induction motors and PM motors

#### General-purpose motor (SF-PR)

Mitsubishi Electric's high-performance energy-saving motor, SF-PR, which complies with Japan's Top Runner standards (equivalent to IE3), can reduce running costs by reducing electricity through energy-saving operation. Since the motor constant, etc. are built-in, energy-saving operation can be performed just by setting the parameters.

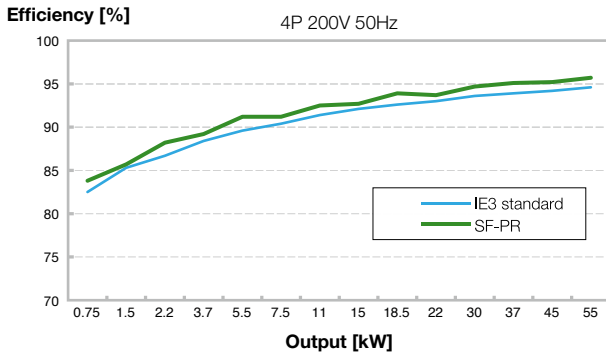

#### PM motor

The PM motor achieves even higher efficiency as compared to the general-purpose motor.

The setting for driving PM motors is enabled just by setting parameters.

#### Why is a PM motor so efficient?

- No current flows to the rotor (secondary side), and no secondary copper loss is generated.
- Magnetic flux is generated with permanent magnets, and less motor current is required.

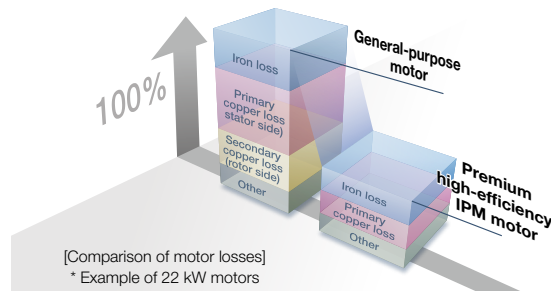

## AC Servo System MELSERVO-J5 Series

MELSERVO-J5 Series compatible with CC-Link IE TSN.

The highly responsive servo amplifier with a speed-frequency response of 3.5 kHz contributes to shortening the takt time of production equipment. The rotary servo motor is equipped with a high-resolution encoder (67,108,864 pulses per revolution) to reduce torque fluctuations and achieve stable control.

By constructing a drive system using the industry's highest performance level servo amplifier and servo motor, the takt time and operating time of the equipment are shortened, and energy saving is achieved.



### Common busbar connection achieving energy-saving, space-saving, and wiring-saving

- Simple Converter MR-CM
- Multi-axis servo amplifiers

Utilizing a common bus connection conserves energy through the efficient use of regenerative power. Wiring can be simplified and installation space can be saved by reducing the number of molded-case circuit breakers and magnetic contactors. The MR-CM simple converter can connect to up to six compatible servo amplifiers having a total capacity of 3 kW or lower.

Wiring for the bus and the control circuit power supply can be simplified by using daisy chain power connectors for passing wiring.

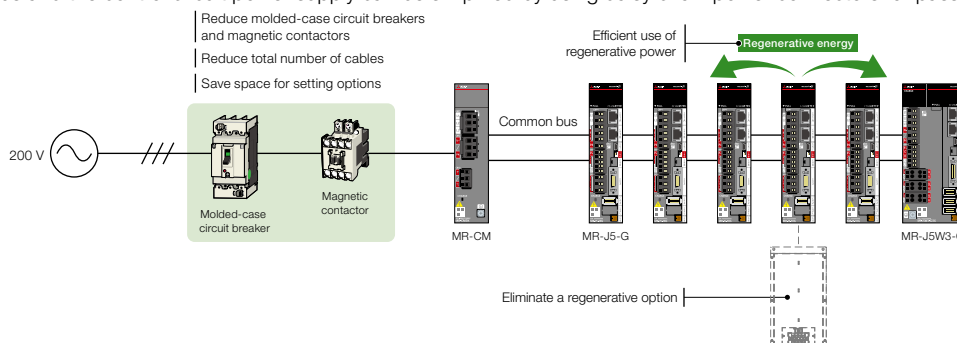

## High Performance Energy-saving Motor – SuperLine Premium Series SF-PR Type

The SuperLine Premium Series SF-PR Type has an original metal frame allowing it to achieve one of the highest efficiency performances in the industry and meet the Top Runner standard of Japan's Act on the Rational Use of Energy.



### Supports IE3 with even higher premium efficiency

Reduces loss by 50% compared to Mitsubishi Electric's standard efficiency motor (SF-JR type IE1 standard) and 20 – 30% compared to our high-efficiency motor (SF-HR type). SF-PR also supports IE3, which is an even higher premium efficiency, thus enabling even higher energy saving during operation.

\* Excludes some models

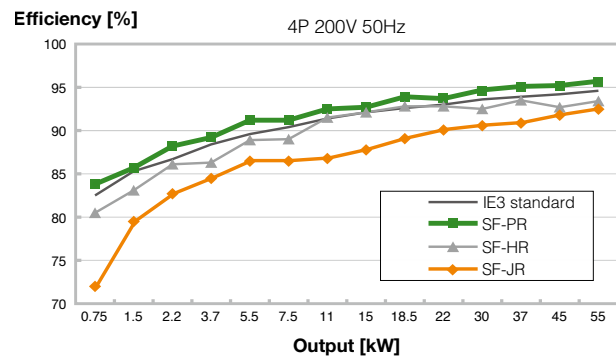



## Air Conducting Fan

Air Conducting Fan helps to improve the indoor environment with a spacious airflow. In combination with an air conditioner, Air Conducting Fan works to improve indoor temperature distribution and raise air conditioning efficiency. It adopts a twin nozzle structure, minimizes airflow attenuation, and achieves airflow over long distances reliable even in large spaces.



### Air Conducting Fan assisted air conditioning

By using an air conditioner and Air Conducting Fan in combination, cool air is distributed throughout an indoor space when cooling, and warm air that rises is blown downward during heating, thus it improves indoor temperature distribution through circulation. It is possible to maintain comfort while increasing air conditioning efficiency and enabling adjustment of air conditioning temperature settings, thus effortlessly saving energy and electricity.

#### Conceptual image of circulation using an Air Conducting Fan

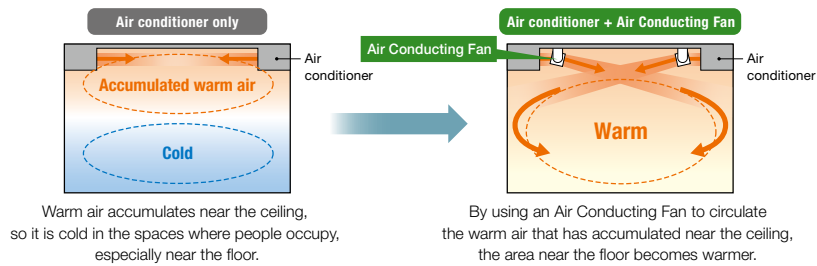

### Air Conducting Fan can be used for these applications as well

#### Ventilation assistance

By using in combination with High Pressure Fan, Air Conducting Fan can efficiently discharge summer heat.

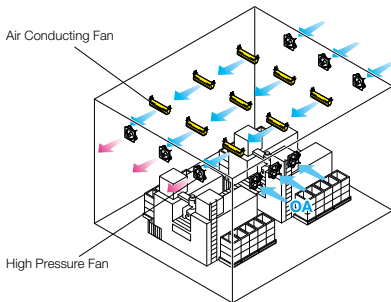

#### Anti-condensation measure

It prevents condensation and mold by creating airflow in the ceiling of showcases used in supermarkets, etc.



#### Cool breeze sensation

By enabling airflow in gymnasiums, etc., it is possible to create a cool breeze sensation at low cost.

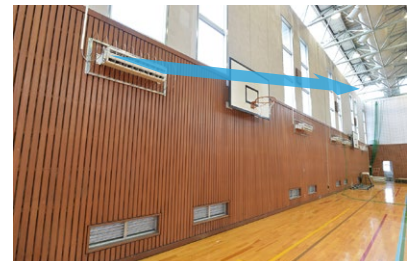

\*The installation in these pictures are cases in Japan.



## Open Integrated Network CC-Link IE TSN

CC-Link IE TSN supports TCP/IP communications and applies it to industrial architectures through its support of TSN enabling real-time communications. With its flexible system architecture and extensive setup and troubleshooting features make CC-Link IE TSN ideal for building an IIoT infrastructure across the entire manufacturing enterprise.



- What is Time-Sensitive Networking (TSN)?  
TSN is the IEEE-defined standard technology that enables deterministic messaging on standard Ethernet. The technology ensures deterministic communications by utilizing the time synchronization method (IEEE 802.1AS) and time-sharing method (IEEE 802.1Qbv). With the addition of these standards to Ethernet technology, real-time control communication and non-real time information communication can be mixed, which is not possible with conventional Ethernet communications.

TSN technology enables the transfer of deterministic communication even when delivering the information communication data of IT systems on the same network. By increasing network bandwidth and giving priority to CC-Link IE TSN communications and TCP/IP communications, devices that use general Ethernet communications can be connected to the same network without affecting real-time control communication performance.



### Time series analysis using high-accuracy time synchronization

Achieves high-accuracy time synchronization with a synchronization accuracy of  $\pm 1\mu\text{s}$  or less and retains timestamp information in each connected station at increments of 1 ms. Error history can be displayed in time series, therefore enabling users to accurately analyze what happened and the cause of the problem from the exact time an error occurs.

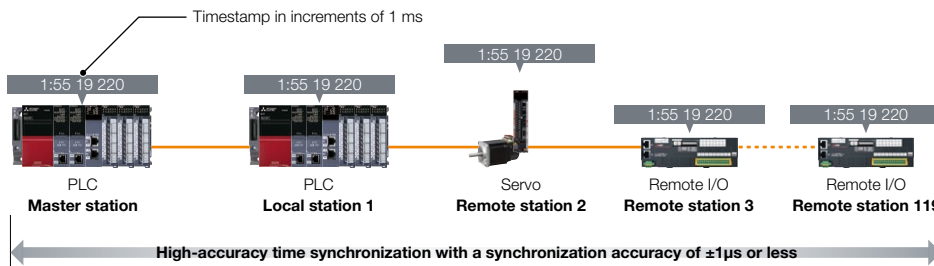

### Easy replacement of slave devices through automatic parameter distribution [Reducing start-up time]

When power is turned on or there is contingency, the master device automatically distributes parameters saved on the CPU unit to slave devices. As such, even when a slave device is replaced, there's no need to separately write parameters to it; making for smooth replacement.

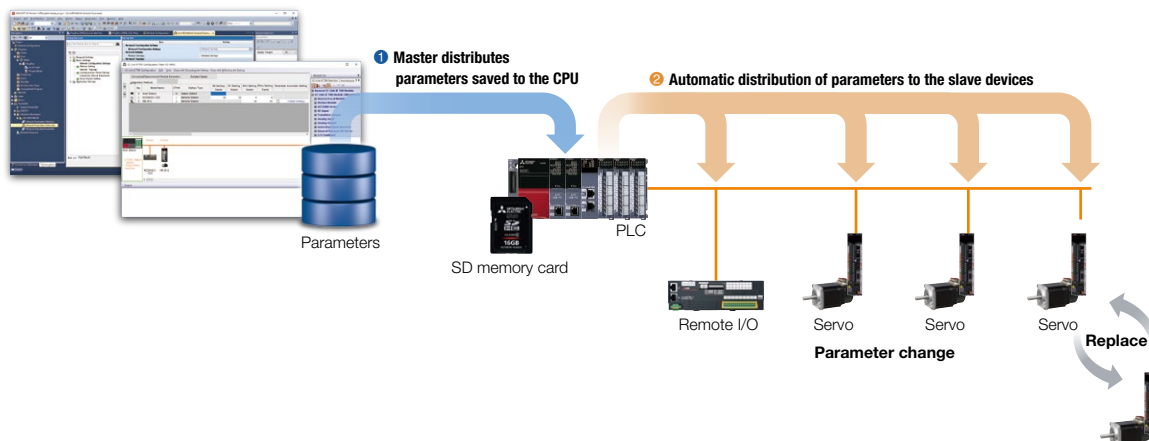

## Open Platform Edgexross

In the manufacturing industry, IoT adaptation is accelerated to enhance competitiveness and create new value. Following the trend, Edgexross Consortium aims to create new added value based on the edge computing layer beyond the borders of companies and industries, contributing to IoT adoption in the manufacturing industry.



### Creating new value with a focus on the edge computing domain

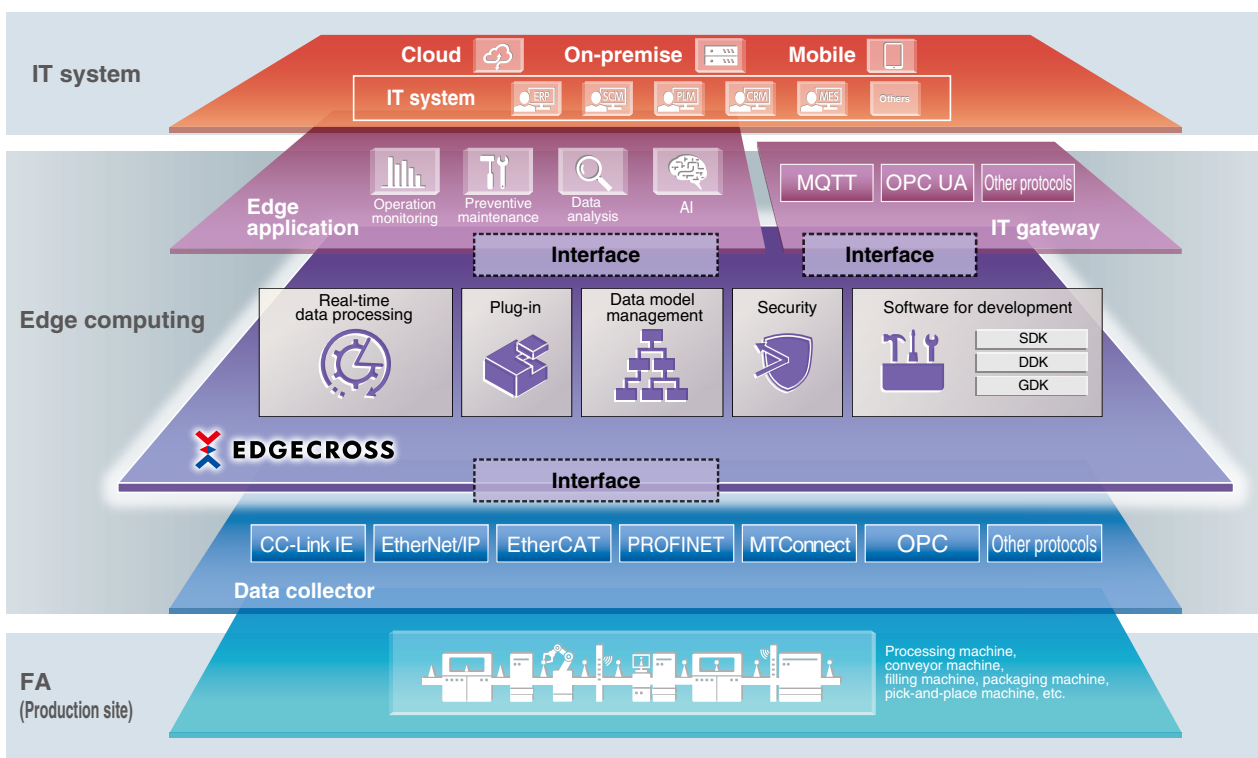

### Contact us

Edgexross Consortium Secretarial office  
**Info@edgexross.org**

Room 301-2, Main Bldg., Kikai Shinko Kaikan Bldg., 3-chome 5-8 Shibakoen, Minato-ku, Tokyo, Japan 105-0011

**Edgexross Consortium**  
<https://www.edgexross.org/en/>

## Mitsubishi Electric AI technologies Maisart

Support the realization of our customers' non-stop factories.

AI is made compact, reducing computing load and enabling the integration of artificial intelligence on the shop floor.

Our FA knowledge supports the application of AI technologies to customers' systems.

Our edge-computing products simplify data collection and support the construction of AI systems.

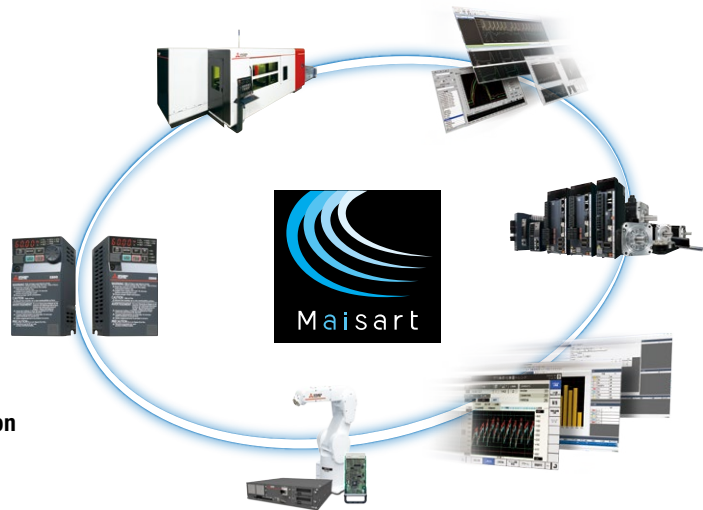

## Features

### Deep Learning

Compared to conventional methods, our compact algorithms reduce deep learning branches by 1/30- 1/100.

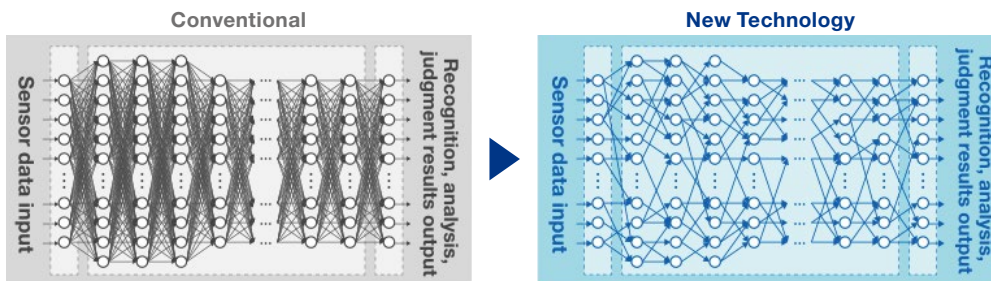

### Reinforcement Learning

Reduces the number of pre-learning trials approximately 1/50 compared to conventional methods by estimating the degree of success through improving learning efficiency using equipment domain knowledge.

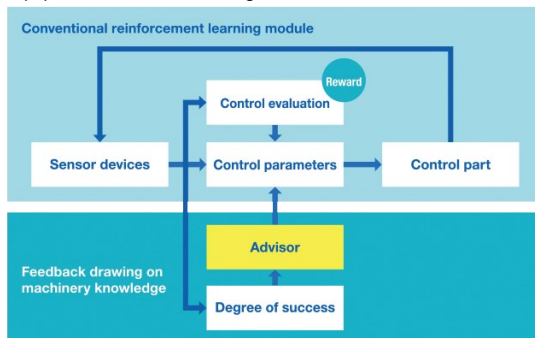

### Big Data Analytics

Reduces the number of operations necessary to detect abnormal signs by 1/40 through streamlining time series data analysis using equipment domain knowledge.

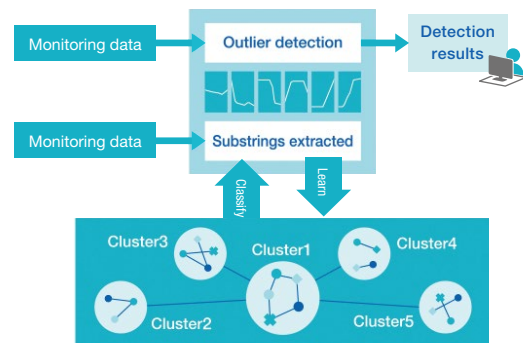

"Maisart" is the name of Mitsubishi Electric's AI technology brand and stands for Mitsubishi Electric's AI creates the State-of-the-ART in technology, with the idea of making everything intelligent (smart) by leveraging original AI technologies.







Edgecross is a registered trademark of the Edgecross Consortium.  
GENESIS64, Hyper Historian, IoTWorX, KPIWorX, MobileHMI, WebHMI and their respective modules, Make the Invisible Visible, and ICONICS company logo, are trademarks of ICONICS, Inc.  
Microsoft, Excel are registered trademarks of Microsoft Corporation in the United States and other countries.  
OPC is a trademark of OPC Foundation.  
OPC UA logo and OPC CERTIFIED logo are registered trademarks of OPC Foundation.  
PCI Express is a registered trademark of PCI-SIG.  
SD/SDHC logo is a trademark of SD-3C, LLC.  
VxWorks is a registered trademarks of Wind River Systems, Inc. in the United States and other countries.  
All other company names and product names used in this document are trademarks or registered trademarks of their respective companies.

#### Precautions before use

This publication explains the typical features and functions of the products herein and does not provide restrictions or other information related to usage and module combinations. Before using the products, always read the product user manuals. Mitsubishi Electric will not be held liable for damage caused by factors found not to be the cause of Mitsubishi Electric; opportunity loss or lost profits caused by faults in Mitsubishi Electric products; damage, secondary damage, or accident compensation, whether foreseeable or not, caused by special factors; damage to products other than Mitsubishi Electric products; or any other duties.

#### For safe use

- To use the products given in this publication properly, always read the relevant manuals before beginning operation.
- The products have been manufactured as general-purpose parts for general industries, and are not designed or manufactured to be incorporated in a device or system used in purposes related to human life.
- Before using the products for special purposes such as nuclear power, electric power, aerospace, medicine or passenger-carrying vehicles, consult with Mitsubishi Electric.
- The products have been manufactured under strict quality control. However, when installing the products where major accidents or losses could occur if the products fail, install appropriate backup or fail-safe functions in the system.

# YOUR SOLUTION PARTNER

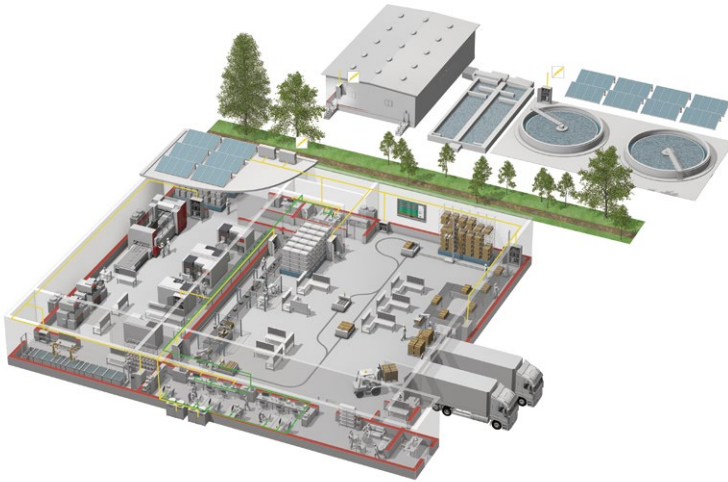

Mitsubishi Electric offers a wide range of automation equipment from PLCs and HMIs to CNC and EDM machines.

## A NAME TO TRUST

Since its beginnings in 1870, some 45 companies use the Mitsubishi name, covering a spectrum of finance, commerce and industry.

The Mitsubishi brand name is recognized around the world as a symbol of premium quality.

Mitsubishi Electric Corporation, established in 1921, is active in space development, transportation, semi-conductors, energy systems, communications and information processing, audio visual equipment and home electronics, building and energy management and automation systems, and has 183 factories, laboratories and offices worldwide in over 140 countries.

This is why you can rely on Mitsubishi Electric automation solution - because we know first hand about the need for reliable, efficient, easy-to-use automation and control in our own factories.

As one of the world's leading companies with a global turnover of over 4 trillion Yen (over \$40 billion), employing over 146,000 people, Mitsubishi Electric has the resource and the commitment to deliver the ultimate in service and support as well as the best products.



Low-voltage Power Distribution Products



Transformers, Med-voltage Distribution Products



Power Monitoring and Energy Saving Products



Power (UPS) and Environmental Products



Compact and Modular Controllers



Servos, Motors and Inverters



Visualization: HMIs



Edge Computing Products



Numerical Control (NC)



Collaborative and Industrial Robots

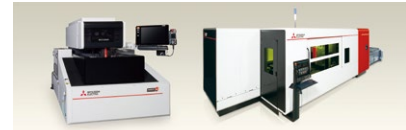

Processing machines: EDM, Lasers

\* Not all products are available in all countries.

# Global Partner. Local Friend.

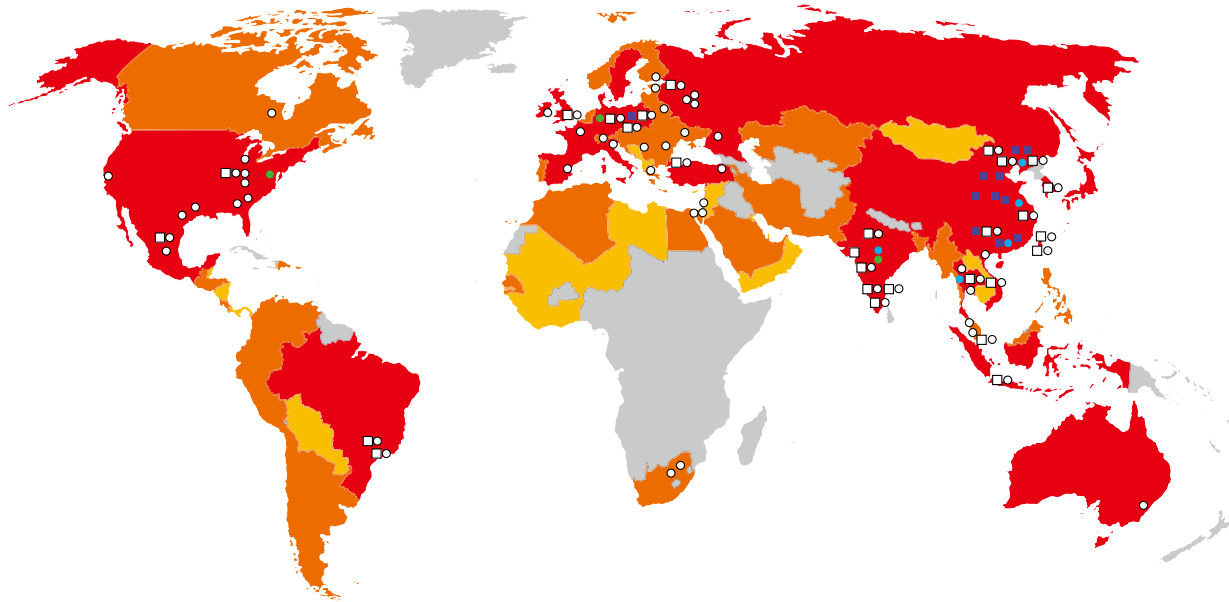

- Sales office
- FA center
- FA center satellite
- Production center
- R&D center

Note: This is a map of our global sales and support coverage. It does not reflect any national borders.

- A region where there are direct Mitsubishi Electric FA offices (main/local and satellite).
- A region covered by primary sales partners (distributors) who have local sales offices.
- A region covered by our extended sales network which may or may not have local offices.

Country/ Region	Sales office	Tel/ Fax			Tel/ Fax
USA	MITSUBISHI ELECTRIC AUTOMATION, INC. 500 Corporate Woods Parkway, Vernon Hills, IL 60061, U.S.A.	Tel : +1-847-478-2100 Fax : +1-847-478-2253	Singapore	MITSUBISHI ELECTRIC ASIA PTE. LTD. 307, Alexandra Road, Mitsubishi Electric Building, Singapore 159943	Tel : +65-6473-2308 Fax : +65-6476-7439
Mexico	MITSUBISHI ELECTRIC AUTOMATION, INC. Mexico Branch Mariano Escobedo #69, Col. Zona Industrial, Tlalnepanitla Edo, C.P.54030, Mexico	Tel : +52-55-3067-7511	Thailand	MITSUBISHI ELECTRIC FACTORY AUTOMATION (THAILAND) CO., LTD. 12th Floor, SV.City Building, Office Tower 1, No. 896/19 and 20 Rama 3 Road, Kwaeng Bangpongpan, Khet Yannawa, Bangkok 10120, Thailand	Tel : +66-2682-6522 Fax : +66-2682-6020
Brazil	MITSUBISHI ELECTRIC DO BRASIL COMÉRCIO E SERVIÇOS LTDA. Avenida Adelino Cardana, 293, 21 andar, Bethaville, Barueri SP, Brazil	Tel : +55-11-4689-3000 Fax : +55-11-4689-3016	Vietnam	MITSUBISHI ELECTRIC VIETNAM COMPANY LIMITED Hanoi Branch 6-Floor, Detech Tower, 8 Ton That Thuyet Street, My Dinh 2 Ward, Nam Tu Liem District, Hanoi, Vietnam	Tel : +84-4-3937-8075 Fax : +84-4-3937-8076
Germany	MITSUBISHI ELECTRIC EUROPE B.V. German Branch Mitsubishi-Electric-Platz 1, 40882 Ratingen, Germany	Tel : +49-2102-486-0 Fax : +49-2102-486-1120	Indonesia	PT. MITSUBISHI ELECTRIC INDONESIA Gedung Jaya 8th Floor, JL. MH. Thamrin No.12, Jakarta Pusat 10340, Indonesia	Tel : +62-21-3192-6461 Fax : +62-21-3192-3942
China	MITSUBISHI ELECTRIC AUTOMATION (CHINA) LTD. No.1386 Hongqiao Road, Mitsubishi Electric Automation Center, Shanghai, China	Tel : +86-21-2322-3030 Fax : +86-21-2322-3000	India	MITSUBISHI ELECTRIC INDIA PVT. LTD. Pune Branch Emerald House, EL -3, J Block, M.I.D.C Bhosari, Pune - 411026, Maharashtra, India	Tel : +91-20-2710-2000 Fax : +91-20-2710-2100
Taiwan	SETSUYO ENTERPRISE CO., LTD. 6F, No.105, Wugong 3rd Road, Wugu District, New Taipei City 24889, Taiwan, R.O.C.	Tel : +886-2-2299-2499 Fax : +886-2-2299-2509	Australia	MITSUBISHI ELECTRIC AUSTRALIA PTY. LTD. 348 Victoria Road, P.O. Box 11, Rydalmere, N.S.W 2116, Australia	Tel : +61-2-9684-7777 Fax : +61-2-9684-7245
Korea	MITSUBISHI ELECTRIC AUTOMATION KOREA CO., LTD. 7F-9F, Gangseo Hangang Xi-tower A, 401, Yangcheon-ro, Gangseo-Gu, Seoul 157-801, Korea	Tel : +82-2-3660-9629/ 9606/9607 Fax : +82-2-3664-0475			

## MITSUBISHI ELECTRIC CORPORATION

HEAD OFFICE: TOKYO BLDG., 2-7-3, MARUNOUCHI, CHIYODA-KU, TOKYO 100-8310, JAPAN  
<https://www.MitsubishiElectric.com/fa/>