

APPLICATION NOTE

Document NO. AN-900-043-A

Date : 30th Sep. 2010

Rev. date : 7th Feb. 2011

Prepared : H.Sakairi

K.Mori

Confirmed : T.Okawa

(Taking charge of Silicon RF by
MIYOSHI Electronics)

SUBJECT: RD04HMS2 single-stage amplifier with f=890-950MHz evaluation board

Features:

- The evaluation board for RD04HMS2
- Frequency: 890-950MHz
- Typical input power: 0.2W
- Typical output power: 5.0W
- Quiescent Current: 100mA
- Operating Current: 0.8A
- Surface-mounted RF power amplifier structure

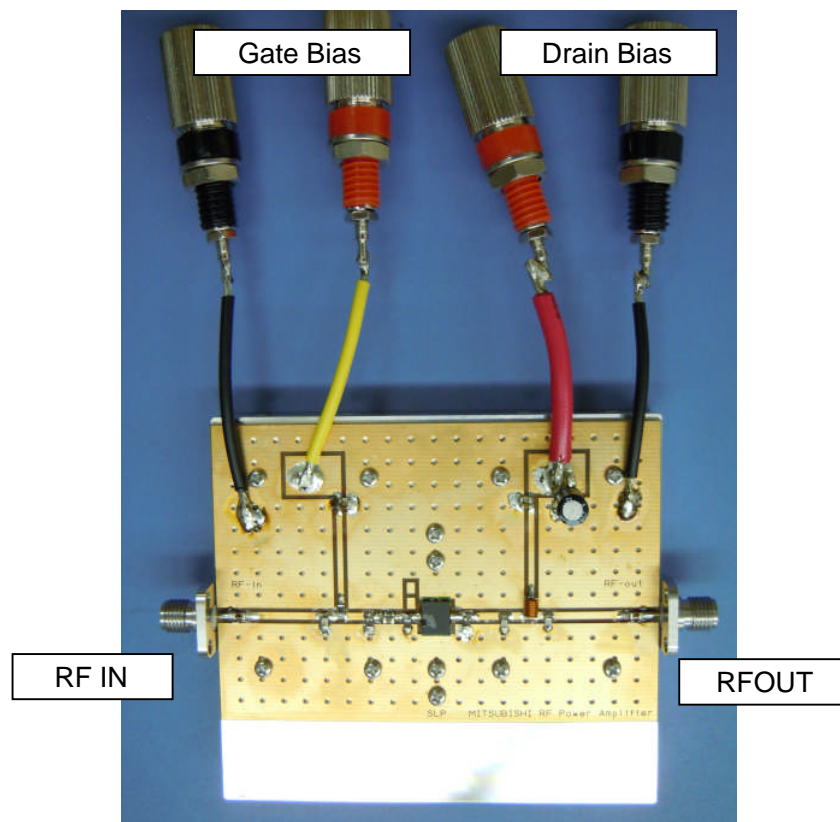

PCB L=80mm W=55mm

Contents

	Page
1. Equivalent Circuitry -----	3
2. PCB Layout -----	4
3. Component List and Standard Deliverable -----	5
4. Thermal Design of Heat Sink -----	6
5. Typical RF Characteristics -----	7
5-1. Frequency vs. (Vds=12.5V) -----	7
5-2. RF Power vs. (Vds=12.5V) -----	8
5-3. Drain Quiescent Current vs. (Vds=12.5V) -----	12
5-4. DC Power Supply vs. (Idq=0.1A) -----	14

1. Equivalent Circuitry

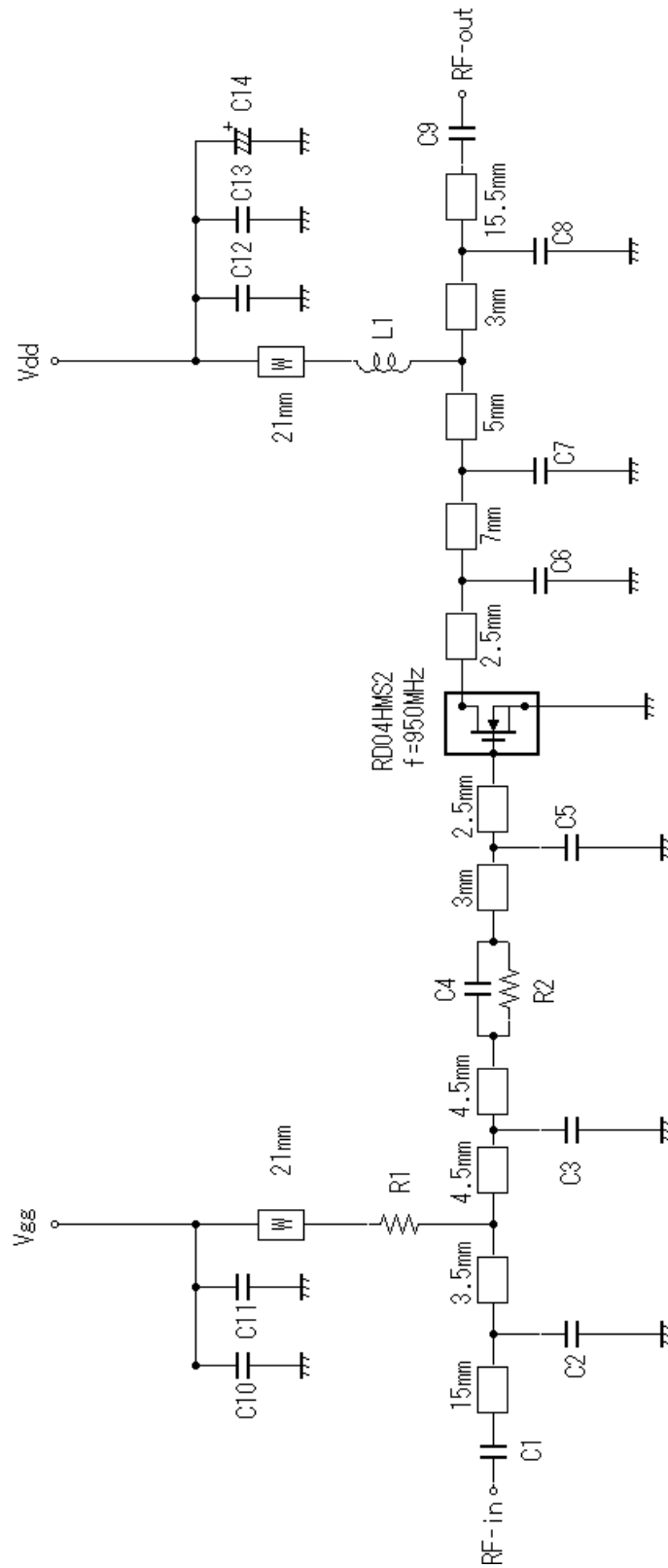

Note: Board material - Glass-Epoxy Substrate
 Micro strip line width=1.3mm/500HM, er:4.8, t=0.8mm
 W: Line width=1.0mm

2. PCB Layout

BOARD OUTLINE: 80.0*55.0(mm)

MATERIAL : FR-4<R1705>

THICKNESS : 0.8(mm)

TOP VIEW

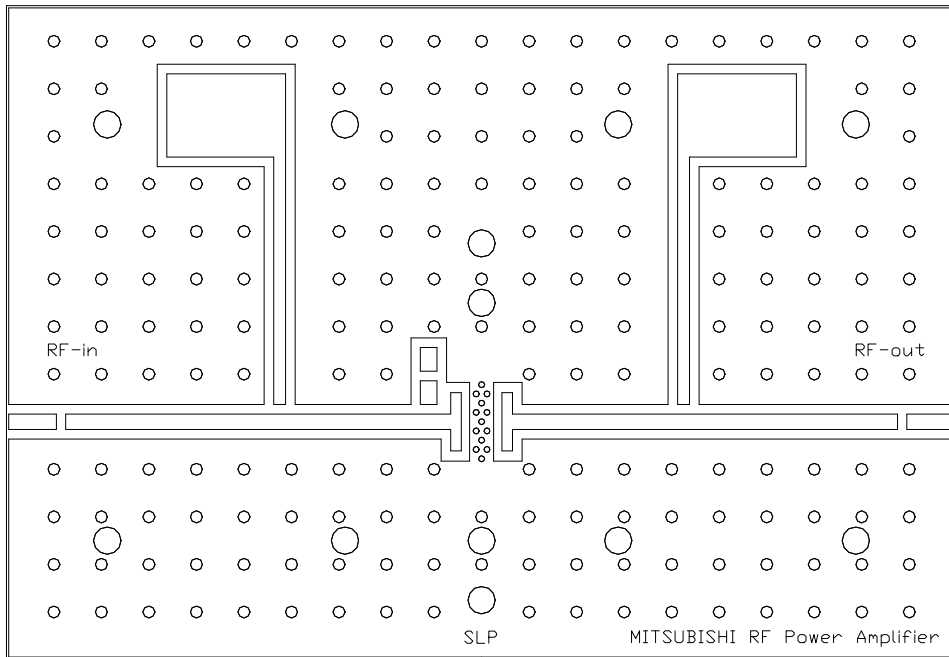

TOP VIEW (Parts mounting)

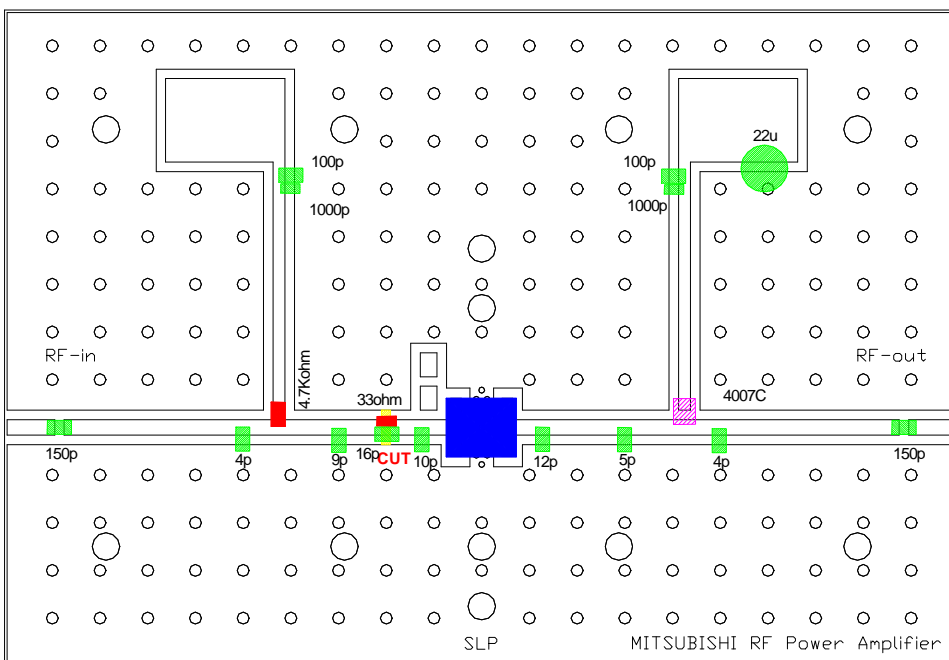

3. Component List

- Component List

No.	Description	P/N	Qty	Manufacturer
Tr	MOSFET	RD04HMS2	1	Mitsubishi Electric Corporation
C 1	150 pF 2012 50V	GRM2162C1H151JA01D	1	MURATA MANUFACTURING CO.
C 2	4 pF 2012 50V	GRM2162C1H4R0CDZ01D	1	MURATA MANUFACTURING CO.
C 3	9 pF 2012 50V	GRM2162C1H9R0DZ01D	1	MURATA MANUFACTURING CO.
C 4	16 pF 2012 50V	GRM2162C1H160JZ01D	1	MURATA MANUFACTURING CO.
C 5	10 pF 2012 50V	GRM2162C1H100JZ01D	1	MURATA MANUFACTURING CO.
C 6	12 pF 2012 50V	GRM2162C1H120JZ01D	1	MURATA MANUFACTURING CO.
C 7	5 pF 2012 50V	GRM2162C1H5R0CD01D	1	MURATA MANUFACTURING CO.
C 8	4 pF 2012 50V	GRM2162C1H4R0CD01D	1	MURATA MANUFACTURING CO.
C 9	150 pF 2012 50V	GRM2162C1H151JA01D	1	MURATA MANUFACTURING CO.
C 10	100 pF 2012 50V	GRM2162C1H101JA01D	1	MURATA MANUFACTURING CO.
C 11	1000 pF 1608 50V	GRM188R11H102KA01E	1	MURATA MANUFACTURING CO.
C 12	100 pF 2012 50V	GRM2162C1H101JA01D	1	MURATA MANUFACTURING CO.
C 13	1000 pF 1608 50V	GRM188R11H102KA01E	1	MURATA MANUFACTURING CO.
C 14	22 uF 50V	H1002	1	NICHICON CORPORATION
L 1	37 nH * Diameter: Wire=0.4mm Inside=1.6mm T/N of coils=7		1	YC CORPORATION Co.,Ltd.
R 1	4.7k ohm 2012	RPC10T472J	1	TAIYOSHA ELECTRIC CO.
R 2	33 ohm 1608	RPC05N330J	1	TAIYOSHA ELECTRIC CO.
Pb	PCB	MS3A0166	1	Homebuilt
Rc	SMA female connector	HRM-300-118S	2	HIROSE ELECTRIC CO.,LTD
Bc 1	Bias connector red color	TM-605R	2	MSK Corporation
Bc 2	Bias connector black color	TM-605B	2	MSK Corporation
Pe	Aluminum pedestal		1	Homebuilt
	Conducting wire		4	Homebuilt
	Screw M2		16	-

* Inductor of Rolling Coil measurement condition : f=100MHz

- Standard Deliverable

TYPE1	Evaluation Board assembled with all the component
TYPE2	PCB (raw board)

4. Thermal Design of Heat Sink

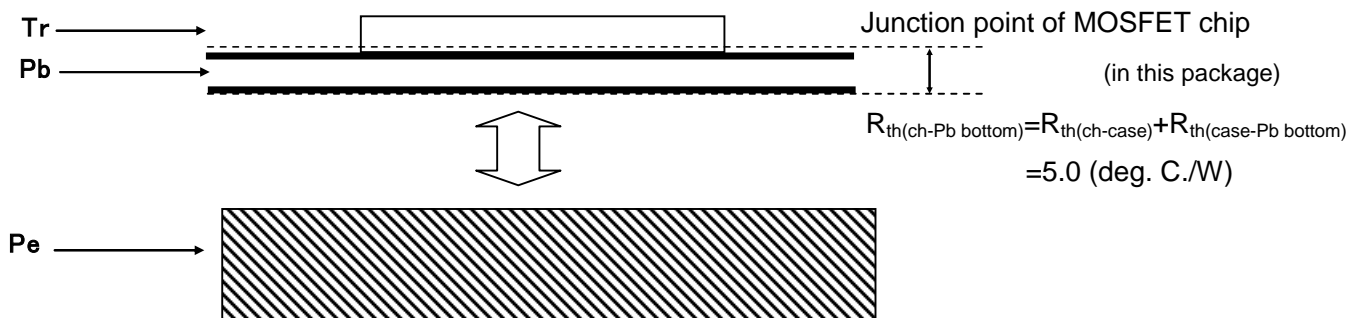

$$T_{ch(\delta)} = (P_{out}/\text{Efficiency} - P_{out} + P_{in}) \times R_{th(ch-Pb\ bottom)} = (4W/50\% - 4W + 0.2) \times 5.0 = 21 \text{ (deg. C.)}$$

Also, operating T_j (" $T_{j(op)}$ ") = 120 (deg. C.), in case of RD series that $T_{ch(max)} = 150$ (deg. C.)

Therefore $T_{Pb\ bottom-air}$ as delta temperature between Pb bottom and the ambient 60 deg. C.

$$T_{Pb\ bottom-air} = "T_{j(op)}" - T_{ch(\delta)} - T_{a(60\text{deg.C.})} = 120 - 21 - 60 = 39 \text{ (deg. C.)}$$

In terms of long-term reliability, " $T_{j(op)}$ " has to be kept less than 120 deg. C. i.e. $T_{Pb\ bottom-air}$ has to be less than 39 deg. C..

The thermal resistance of the heat sink to border it:

$$R_{th(Pb\ bottom-air)} = T_{Pb\ bottom-air} / (P_{out}/\text{Efficiency} - P_{out} + P_{in}) = 39 / (4W/50\% - 4W + 0.2) = 9.3 \text{ (deg. C./W)}$$

Therefore

it is preferable that the thermal resistance of the heat sink is much smaller than 9.3 deg. C./W.

5. Typical Performance

5-1. Frequency vs.

OUTPUT POWER, POWER GAIN, DRAIN EFFICIENCY, DRAIN CURRENT and INPUT RETURN LOSS

(Vds=12.5V)

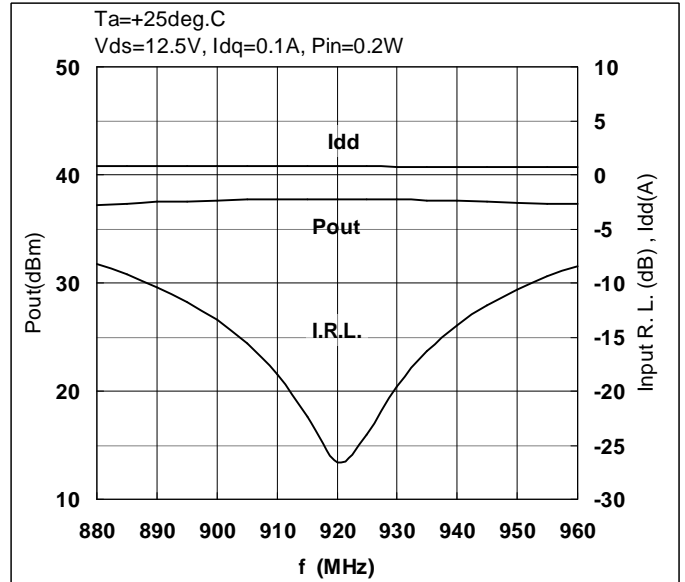
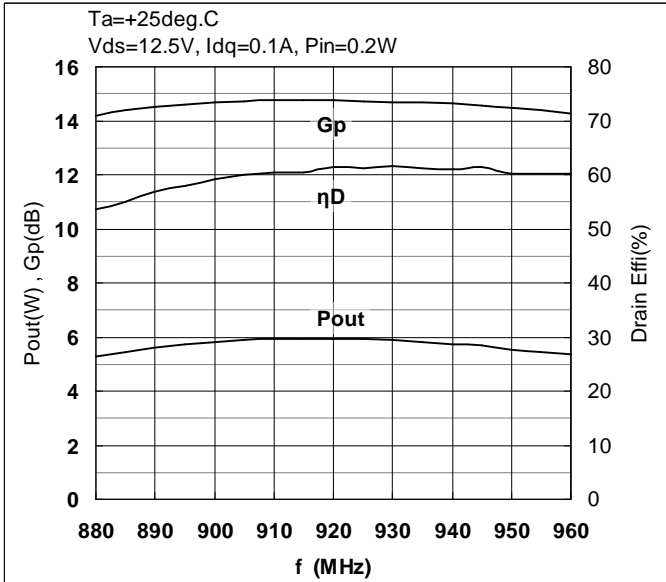

Ta=+25deg. C., Vds=12.5V, Idq=0.1A, Pin=0.2W

Freq. (MHz)	Vgg (V)	Pin		Pout		Gp (dB)	ID(RF) (A)	ηadd (%)	ηD (%)	I.R.L. (dB)
		(dBm)	(W)	(dBm)	(W)					
880	2.65	23.0	0.2	37.2	5.3	14.2	0.79	51.5	53.5	-8.3
885	2.65	23.0	0.2	37.4	5.4	14.4	0.79	53.1	55.2	-9.2
890	2.65	23.0	0.2	37.5	5.6	14.5	0.79	54.8	56.8	-10.4
895	2.65	23.0	0.2	37.6	5.7	14.6	0.79	56.0	58.0	-11.7
900	2.65	23.0	0.2	37.7	5.8	14.7	0.79	57.2	59.2	-13.4
905	2.65	23.0	0.2	37.7	5.9	14.7	0.79	58.0	60.1	-15.5
910	2.65	23.0	0.2	37.8	6.0	14.8	0.79	58.4	60.5	-18.4
915	2.65	23.0	0.2	37.8	6.0	14.8	0.79	58.5	60.5	-22.4
920	2.65	23.0	0.2	37.7	5.9	14.8	0.78	59.3	61.3	-26.6
925	2.65	23.0	0.2	37.7	5.9	14.7	0.78	59.2	61.2	-24.0
930	2.65	23.0	0.2	37.7	5.9	14.7	0.76	59.6	61.7	-19.5
935	2.65	23.0	0.2	37.7	5.8	14.7	0.76	59.1	61.2	-16.3
940	2.65	23.0	0.2	37.6	5.7	14.6	0.75	59.0	61.1	-13.9
945	2.65	23.0	0.2	37.5	5.7	14.5	0.74	59.4	61.5	-12.1
950	2.65	23.0	0.2	37.4	5.5	14.5	0.74	58.0	60.1	-10.6
955	2.65	23.0	0.2	37.4	5.5	14.4	0.73	58.0	60.2	-9.4
960	2.65	23.0	0.2	37.3	5.4	14.3	0.71	58.0	60.3	-8.4

5-2. RF Power vs.

INPUT POWER (Vds=12.5V)

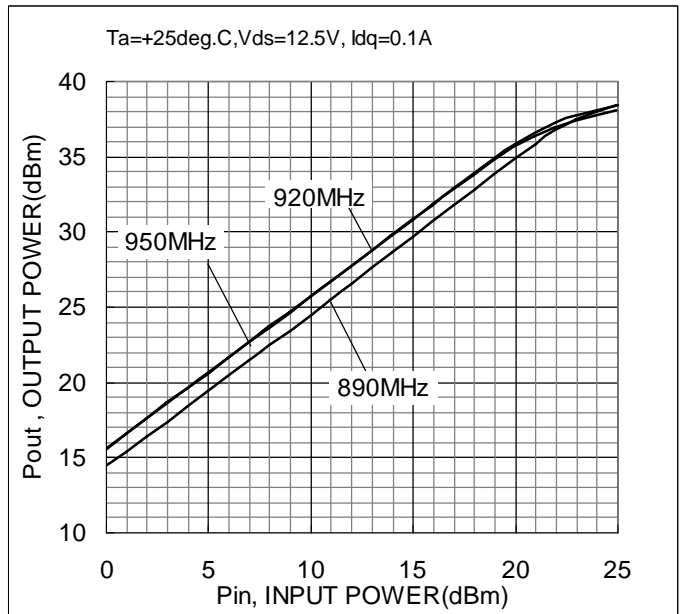
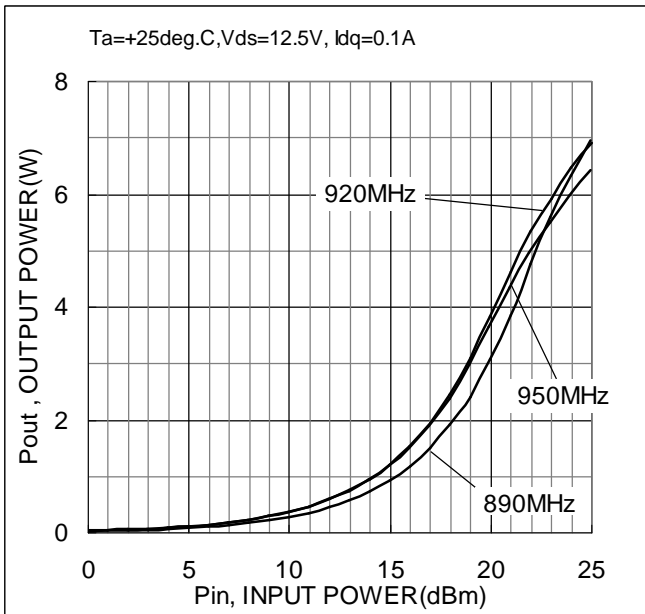

POWER GAIN (Vds=12.5V)

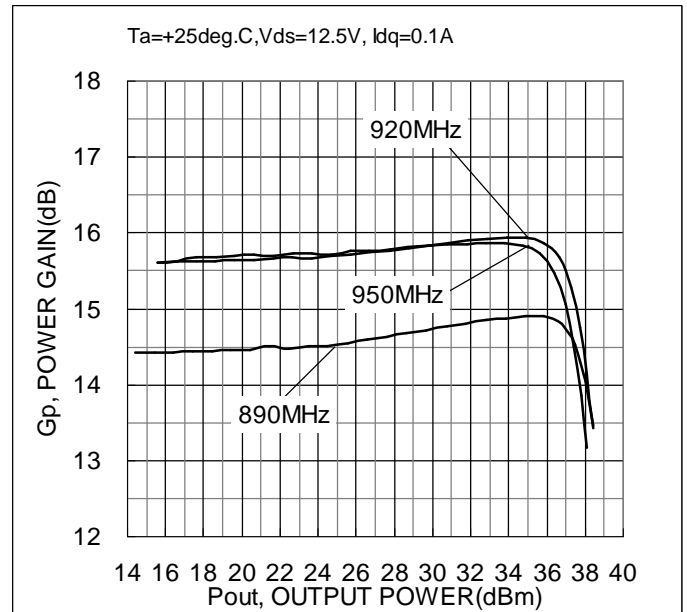
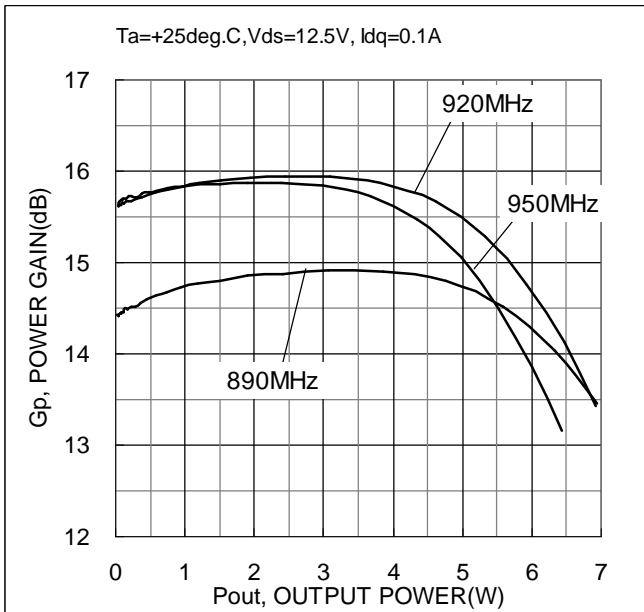

DRAIN EFFICIENCY (Vds=12.5V)

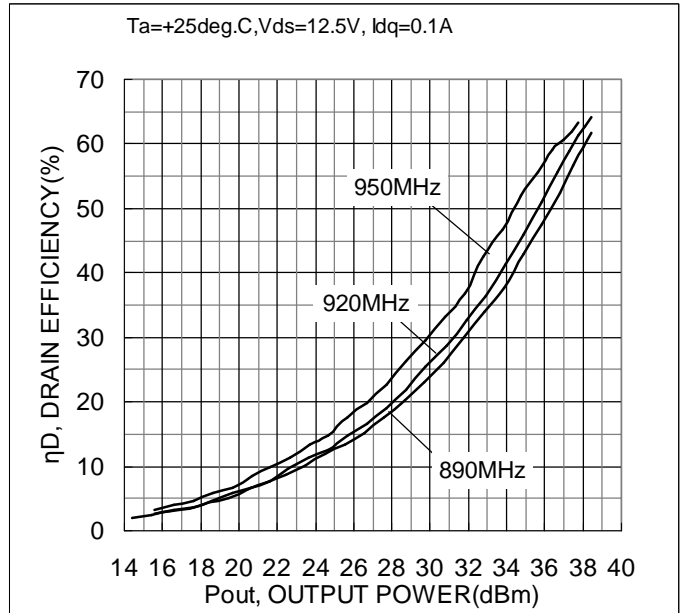
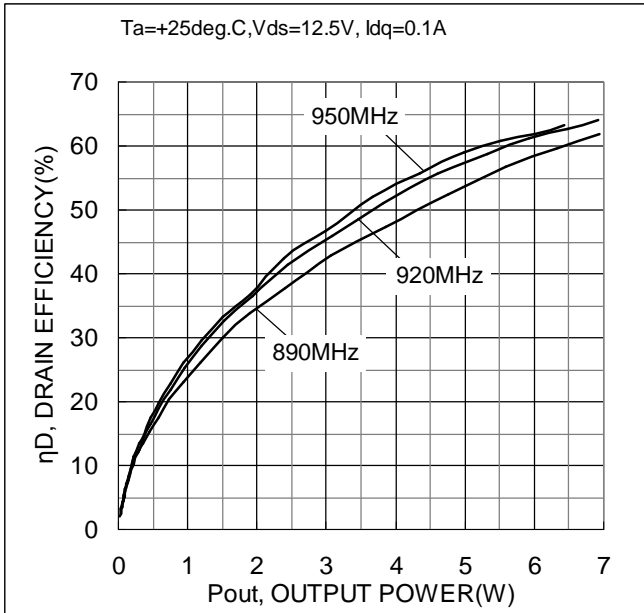

DRAIN CURRENT (Vds=12.5V)

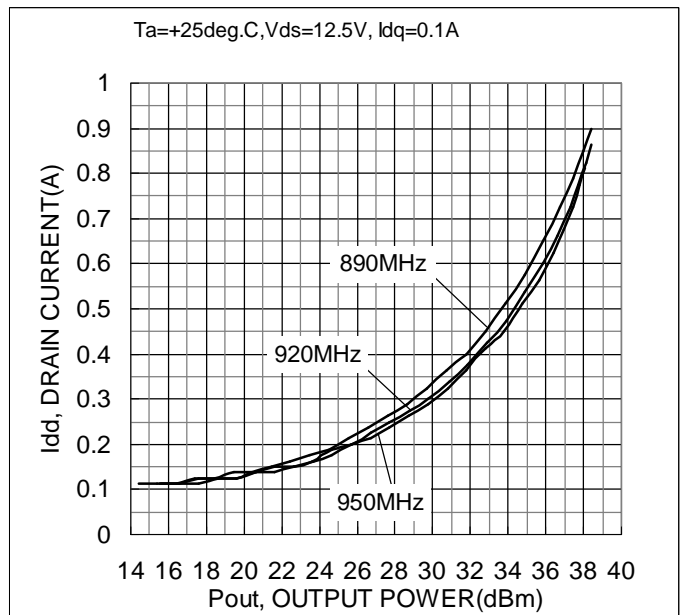
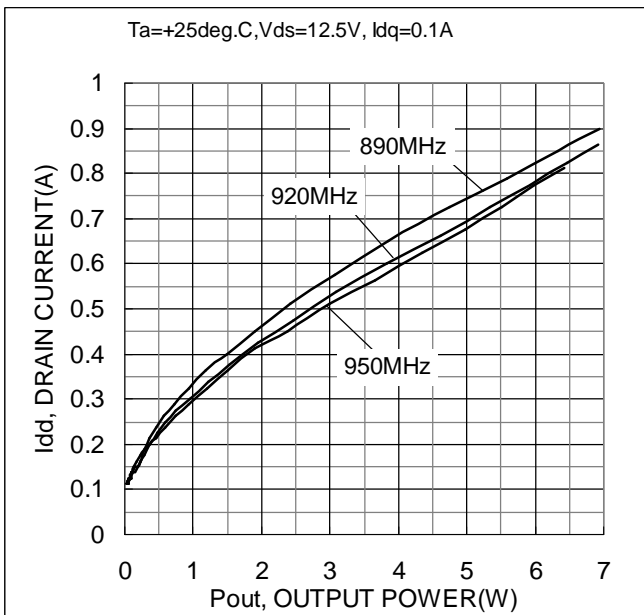

INPUT RETURN LOSS (Vds=12.5V)

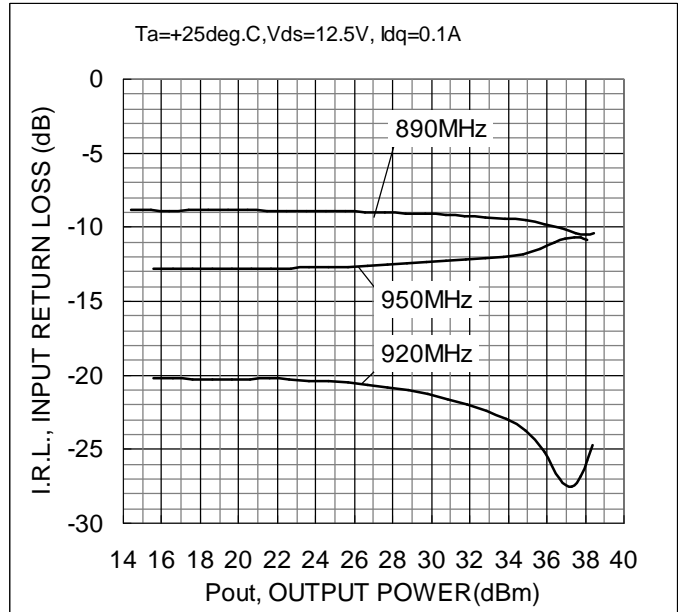
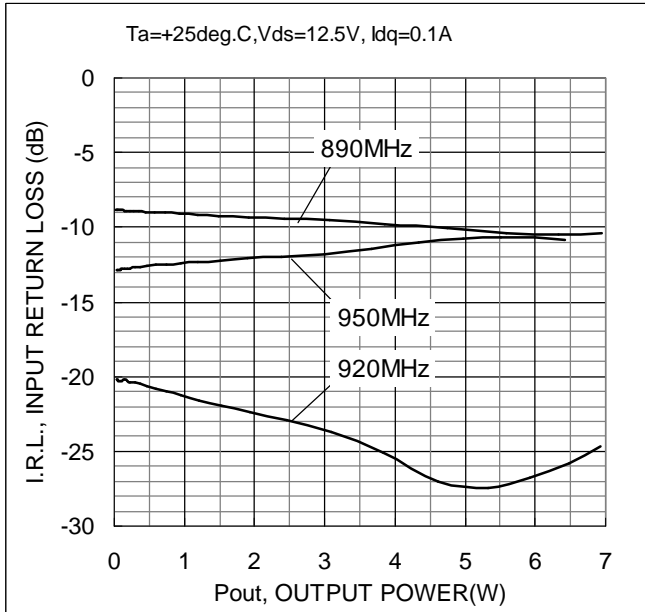

Ta=+25deg. C., Vds=12.5V, Idq=0.1A

890MHz	V _{gg} (V)	P _{in} (dBm)	P _{in} (W)	P _{out} (dBm)	P _{out} (W)	G _p (dB)	I _D (RF) (A)	η _{add} (%)	η _D (%)	I.R.L. (dB)
	2.65	0.0	0.00	14.4	0.0	14.4	0.11	1.9	1.9	-8.9
	2.65	1.0	0.00	15.4	0.0	14.4	0.11	2.4	2.5	-8.9
	2.65	2.0	0.00	16.4	0.0	14.4	0.11	3.0	3.1	-8.9
	2.65	3.0	0.00	17.4	0.1	14.4	0.13	3.4	3.5	-8.9
	2.65	4.0	0.00	18.4	0.1	14.4	0.13	4.3	4.5	-8.9
	2.65	5.0	0.00	19.4	0.1	14.5	0.14	4.9	5.1	-8.9
	2.65	6.0	0.00	20.5	0.1	14.5	0.14	6.2	6.4	-8.9
	2.65	7.0	0.00	21.5	0.1	14.5	0.15	7.2	7.5	-8.9
	2.65	8.0	0.01	22.5	0.2	14.5	0.16	8.3	8.6	-8.9
	2.65	9.0	0.01	23.5	0.2	14.5	0.18	9.8	10.2	-8.9
	2.65	10.0	0.01	24.5	0.3	14.5	0.19	11.6	12.0	-8.9
	2.65	11.0	0.01	25.5	0.4	14.6	0.21	12.9	13.4	-8.9
	2.65	12.0	0.02	26.6	0.5	14.6	0.24	14.7	15.2	-9.0
	2.65	13.0	0.02	27.6	0.6	14.6	0.26	16.9	17.5	-9.0
	2.65	14.0	0.02	28.6	0.7	14.7	0.29	19.6	20.3	-9.1
	2.65	15.0	0.03	29.7	0.9	14.7	0.33	22.2	23.0	-9.1
	2.65	16.0	0.04	30.7	1.2	14.8	0.36	25.3	26.1	-9.2
	2.65	16.9	0.05	31.8	1.5	14.8	0.40	28.9	29.9	-9.2
	2.65	18.0	0.06	32.8	1.9	14.9	0.45	32.8	34.0	-9.3
	2.65	19.0	0.08	33.8	2.4	14.9	0.51	36.4	37.7	-9.4
	2.65	20.0	0.10	34.9	3.1	14.9	0.58	41.4	42.8	-9.6
	2.65	21.0	0.12	35.9	3.9	14.9	0.65	45.9	47.4	-9.8
	2.65	22.0	0.16	36.8	4.8	14.8	0.73	50.7	52.5	-10.1
	2.65	23.0	0.20	37.5	5.6	14.5	0.79	54.7	56.7	-10.4
	2.65	24.0	0.25	38.0	6.3	14.0	0.85	57.2	59.5	-10.5
	2.65	25.0	0.31	38.4	7.0	13.5	0.90	59.0	61.8	-10.4

RD04HMS2 single-stage amplifier with f=890-950MHz evaluation board

- AN-900-043-A-

920MHz	V _{gg}	Pin		P _{out}		G _p	ID(RF)	η _{add}	η _D	I.R.L.
	(V)	(dBm)	(W)	(dBm)	(W)	(dB)	(A)	(%)	(%)	(dB)
	2.65	0.0	0.00	15.6	0.0	15.6	0.11	2.5	2.6	-20.2
	2.65	1.0	0.00	16.6	0.0	15.6	0.11	3.1	3.2	-20.2
	2.65	2.0	0.00	17.6	0.1	15.6	0.13	3.6	3.7	-20.3
	2.65	3.0	0.00	18.6	0.1	15.6	0.13	4.5	4.6	-20.3
	2.65	4.0	0.00	19.6	0.1	15.7	0.13	5.7	5.9	-20.3
	2.65	5.0	0.00	20.6	0.1	15.6	0.14	6.5	6.7	-20.3
	2.65	6.0	0.00	21.6	0.1	15.7	0.15	7.6	7.8	-20.2
	2.65	7.0	0.00	22.6	0.2	15.7	0.15	9.5	9.8	-20.3
	2.65	8.0	0.01	23.6	0.2	15.7	0.16	11.0	11.3	-20.3
	2.65	9.0	0.01	24.7	0.3	15.7	0.19	12.1	12.4	-20.4
	2.65	10.0	0.01	25.7	0.4	15.7	0.20	14.4	14.8	-20.5
	2.65	11.0	0.01	26.7	0.5	15.7	0.23	16.2	16.6	-20.6
	2.65	12.0	0.02	27.7	0.6	15.8	0.25	18.4	18.9	-20.8
	2.65	13.0	0.02	28.8	0.8	15.8	0.28	21.3	21.9	-21.0
	2.65	14.0	0.02	29.8	1.0	15.8	0.30	24.7	25.4	-21.3
	2.65	15.0	0.03	30.8	1.2	15.9	0.34	28.0	28.7	-21.6
	2.65	16.0	0.04	31.9	1.5	15.9	0.38	31.8	32.7	-21.9
	2.65	16.9	0.05	32.9	1.9	15.9	0.43	35.5	36.5	-22.4
	2.65	18.0	0.06	33.9	2.5	15.9	0.48	40.3	41.3	-23.0
	2.65	19.0	0.08	34.9	3.1	15.9	0.54	44.8	46.0	-23.7
	2.65	20.0	0.10	35.8	3.8	15.9	0.60	49.7	51.0	-25.1
	2.65	21.0	0.12	36.6	4.6	15.7	0.66	54.2	55.7	-27.0
	2.65	22.0	0.16	37.3	5.3	15.3	0.73	57.1	58.9	-27.5
	2.65	23.0	0.20	37.7	5.9	14.8	0.78	59.2	61.2	-26.8
	2.65	24.0	0.25	38.1	6.5	14.1	0.83	60.3	62.8	-25.8
	2.65	25.0	0.31	38.4	6.9	13.4	0.86	61.2	64.1	-24.7

950MHz	V _{gg}	Pin		P _{out}		G _p	ID(RF)	η _{add}	η _D	I.R.L.
	(V)	(dBm)	(W)	(dBm)	(W)	(dB)	(A)	(%)	(%)	(dB)
	2.65	-0.1	0.00	15.6	0.0	15.6	0.11	2.5	2.5	-12.8
	2.65	0.9	0.00	16.6	0.0	15.6	0.11	3.1	3.2	-12.8
	2.65	1.9	0.00	17.6	0.1	15.7	0.11	4.0	4.1	-12.8
	2.65	2.9	0.00	18.6	0.1	15.7	0.13	4.5	4.7	-12.8
	2.65	3.9	0.00	19.6	0.1	15.7	0.13	5.7	5.9	-12.8
	2.65	5.0	0.00	20.7	0.1	15.7	0.14	6.6	6.7	-12.8
	2.65	5.9	0.00	21.6	0.1	15.7	0.14	8.2	8.5	-12.8
	2.65	6.9	0.00	22.7	0.2	15.7	0.15	9.6	9.8	-12.8
	2.65	7.9	0.01	23.7	0.2	15.7	0.16	11.1	11.4	-12.7
	2.65	8.9	0.01	24.7	0.3	15.7	0.18	13.0	13.4	-12.7
	2.65	9.9	0.01	25.7	0.4	15.8	0.20	14.5	14.9	-12.7
	2.65	10.9	0.01	26.7	0.5	15.8	0.21	17.1	17.5	-12.6
	2.65	11.9	0.02	27.7	0.6	15.8	0.24	19.4	19.9	-12.5
	2.65	12.9	0.02	28.7	0.7	15.8	0.26	22.2	22.8	-12.5
	2.65	13.9	0.02	29.8	0.9	15.8	0.29	25.5	26.2	-12.4
	2.65	14.9	0.03	30.8	1.2	15.9	0.33	28.8	29.5	-12.3
	2.65	15.9	0.04	31.8	1.5	15.9	0.36	32.3	33.2	-12.2
	2.65	16.9	0.05	32.8	1.9	15.9	0.41	35.9	36.8	-12.1
	2.65	17.9	0.06	33.8	2.4	15.9	0.45	41.4	42.4	-12.0
	2.65	18.9	0.08	34.8	3.0	15.8	0.51	45.4	46.7	-11.8
	2.65	19.9	0.10	35.6	3.7	15.7	0.56	50.7	52.1	-11.5
	2.65	20.9	0.12	36.4	4.3	15.5	0.63	54.0	55.6	-11.0
	2.65	21.9	0.16	37.0	5.0	15.1	0.68	57.1	59.0	-10.7
	2.65	22.9	0.20	37.4	5.5	14.5	0.73	58.6	60.8	-10.7
	2.65	23.9	0.25	37.8	6.0	13.9	0.78	59.4	61.9	-10.7
	2.65	24.9	0.31	38.1	6.4	13.2	0.81	60.2	63.2	-10.8

5-3. Drain Quiescent Current vs.

OUTPUT POWER and DRAIN EFFICIENCY (Vds=12.5V)

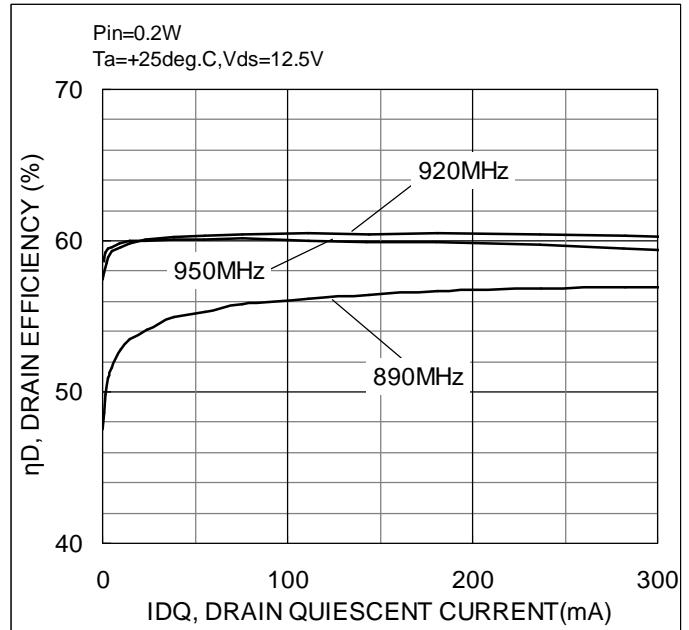
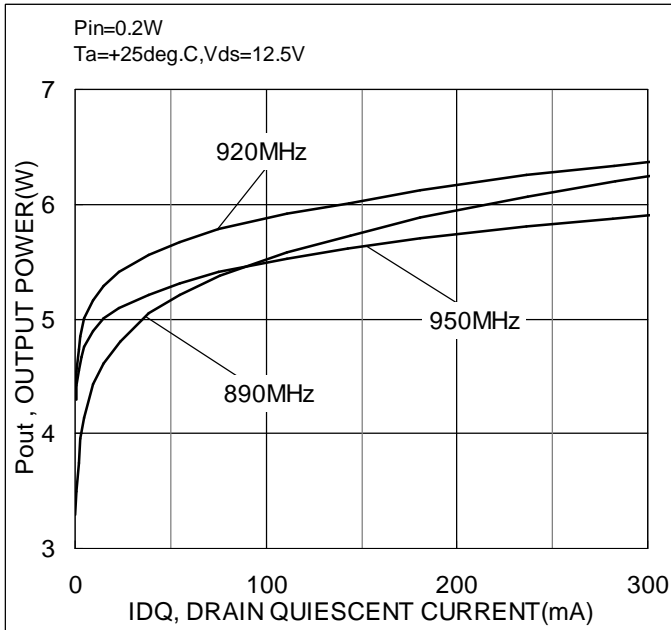

Ta=+25deg. C., Vds=12.5V, Pin=0.2W

890MHz	Vgg (V)	Idq (mA)	Pin (dBm)	Pin (W)	Pout (dBm)	Pout (W)	Idd (A)	η_D (%)	η_{add} (%)	Gain (dB)	I.R.L. (dB)
	2.10	0.3	23.0	0.2	35.2	3.3	0.55	47.5	44.6	12.2	-8.0
	2.15	0.8	23.0	0.2	35.4	3.5	0.58	48.7	45.9	12.4	-8.1
	2.21	1.7	23.0	0.2	35.7	3.7	0.60	49.8	47.2	12.7	-8.4
	2.25	3.0	23.0	0.2	36.0	4.0	0.62	50.9	48.3	13.0	-8.5
	2.30	4.8	23.0	0.2	36.2	4.1	0.64	51.6	49.1	13.2	-8.7
	2.36	9.5	23.0	0.2	36.5	4.4	0.67	52.8	50.5	13.5	-9.0
	2.40	15.0	23.0	0.2	36.6	4.6	0.69	53.5	51.2	13.6	-9.2
	2.45	23.5	23.0	0.2	36.8	4.8	0.71	54.1	51.8	13.8	-9.4
	2.51	38.7	23.0	0.2	37.0	5.0	0.74	54.9	52.7	14.0	-9.7
	2.55	55.0	23.0	0.2	37.2	5.2	0.75	55.3	53.2	14.2	-9.9
	2.60	75.6	23.0	0.2	37.3	5.4	0.77	55.8	53.7	14.3	-10.1
	2.66	111.3	23.0	0.2	37.5	5.6	0.80	56.1	54.1	14.5	-10.4
	2.70	144.1	23.0	0.2	37.6	5.7	0.81	56.4	54.4	14.6	-10.6
	2.75	181.1	23.0	0.2	37.7	5.9	0.83	56.7	54.7	14.7	-10.8
	2.81	236.9	23.0	0.2	37.8	6.1	0.86	56.8	54.9	14.8	-11.1
	2.85	282.8	23.0	0.2	37.9	6.2	0.87	56.9	55.1	14.9	-11.3
	2.90	331.5	23.0	0.2	38.0	6.3	0.89	57.0	55.2	15.0	-11.6

RD04HMS2 single-stage amplifier with f=890-950MHz evaluation board

- AN-900-043-A-

920MHz	V _{gg} (V)	I _{dq} (mA)	P _{in} (dBm) (W)		P _{out} (dBm) (W)		I _{dd} (A)	η _D (%)	η _{add} (%)	Gain (dB)	I.R.L. (dB)
	2.10	0.3	23.0	0.2	36.4	4.4	0.61	57.4	54.8	13.4	-18.3
	2.15	0.8	23.0	0.2	36.6	4.5	0.63	57.9	55.4	13.5	-18.9
	2.21	1.8	23.0	0.2	36.8	4.7	0.65	58.5	56.1	13.7	-19.7
	2.25	3.0	23.0	0.2	36.9	4.9	0.66	58.9	56.4	13.9	-20.3
	2.30	4.8	23.0	0.2	37.0	5.0	0.68	59.3	56.9	14.0	-20.9
	2.36	9.5	23.0	0.2	37.1	5.2	0.69	59.5	57.2	14.1	-21.8
	2.40	14.9	23.0	0.2	37.2	5.3	0.71	59.8	57.6	14.2	-22.5
	2.45	23.3	23.0	0.2	37.3	5.4	0.72	60.1	57.9	14.3	-23.2
	2.51	38.5	23.0	0.2	37.5	5.6	0.74	60.2	58.1	14.4	-24.2
	2.55	55.0	23.0	0.2	37.5	5.7	0.75	60.4	58.2	14.5	-25.0
	2.60	75.4	23.0	0.2	37.6	5.8	0.77	60.4	58.3	14.6	-25.7
	2.66	111.0	23.0	0.2	37.7	5.9	0.78	60.5	58.5	14.7	-26.5
	2.70	143.8	23.0	0.2	37.8	6.0	0.80	60.4	58.4	14.8	-27.0
	2.75	180.9	23.0	0.2	37.9	6.1	0.81	60.5	58.6	14.9	-27.4
	2.81	236.4	23.0	0.2	38.0	6.3	0.83	60.5	58.5	15.0	-27.4
	2.85	282.3	23.0	0.2	38.0	6.3	0.84	60.3	58.4	15.0	-27.2
	2.90	331.1	23.0	0.2	38.1	6.4	0.86	60.2	58.3	15.1	-26.8

950MHz	V _{gg} (V)	I _{dq} (mA)	P _{in} (dBm) (W)		P _{out} (dBm) (W)		I _{dd} (A)	η _D (%)	η _{add} (%)	Gain (dB)	I.R.L. (dB)
	2.10	0.4	23.0	0.2	36.3	4.3	0.59	58.6	55.9	13.3	-13.0
	2.15	0.9	23.0	0.2	36.5	4.4	0.60	58.9	56.2	13.4	-12.7
	2.21	1.7	23.0	0.2	36.6	4.5	0.61	59.2	56.7	13.6	-12.5
	2.25	3.0	23.0	0.2	36.7	4.7	0.63	59.5	57.0	13.7	-12.3
	2.30	4.7	23.0	0.2	36.8	4.8	0.64	59.6	57.1	13.8	-12.1
	2.36	9.4	23.0	0.2	36.9	4.9	0.66	59.8	57.3	13.9	-11.8
	2.40	14.9	23.0	0.2	37.0	5.0	0.67	60.0	57.6	14.0	-11.6
	2.45	23.3	23.0	0.2	37.1	5.1	0.68	60.0	57.7	14.1	-11.4
	2.51	38.5	23.0	0.2	37.2	5.2	0.69	60.1	57.8	14.2	-11.2
	2.55	54.9	23.0	0.2	37.3	5.3	0.71	60.1	57.8	14.3	-11.0
	2.60	75.3	23.0	0.2	37.3	5.4	0.72	60.1	57.9	14.3	-10.8
	2.66	111.1	23.0	0.2	37.4	5.5	0.74	60.0	57.9	14.4	-10.6
	2.70	142.7	23.0	0.2	37.5	5.6	0.75	59.9	57.8	14.5	-10.4
	2.75	180.5	23.0	0.2	37.6	5.7	0.76	59.9	57.8	14.5	-10.3
	2.81	236.5	23.0	0.2	37.6	5.8	0.78	59.7	57.7	14.6	-10.1
	2.85	282.0	23.0	0.2	37.7	5.9	0.79	59.5	57.5	14.7	-9.9
	2.90	330.7	23.0	0.2	37.8	6.0	0.81	59.2	57.2	14.7	-9.8

5-4. DC Power Supply vs.

OUTPUT POWER and DRAIN EFFICIENCY ($I_{dq}=0.1A$)

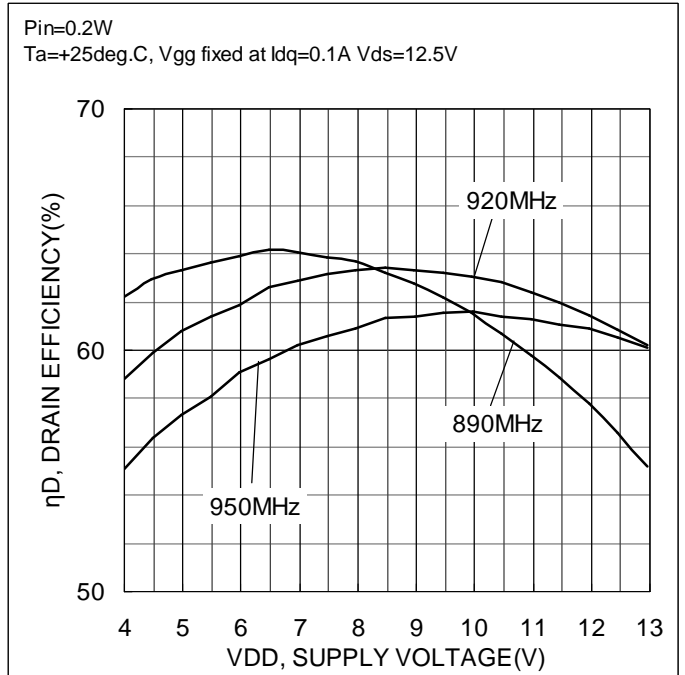
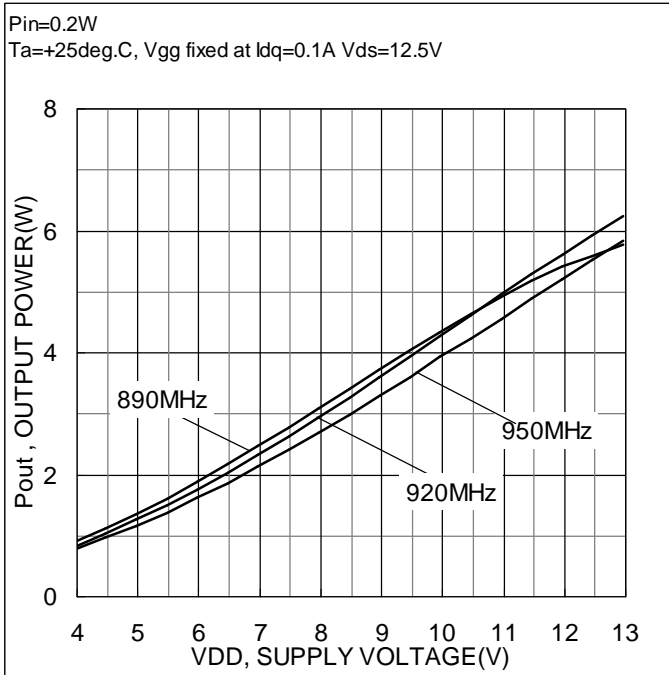

DRAIN CURRENT ($I_{dq}=0.1A$)

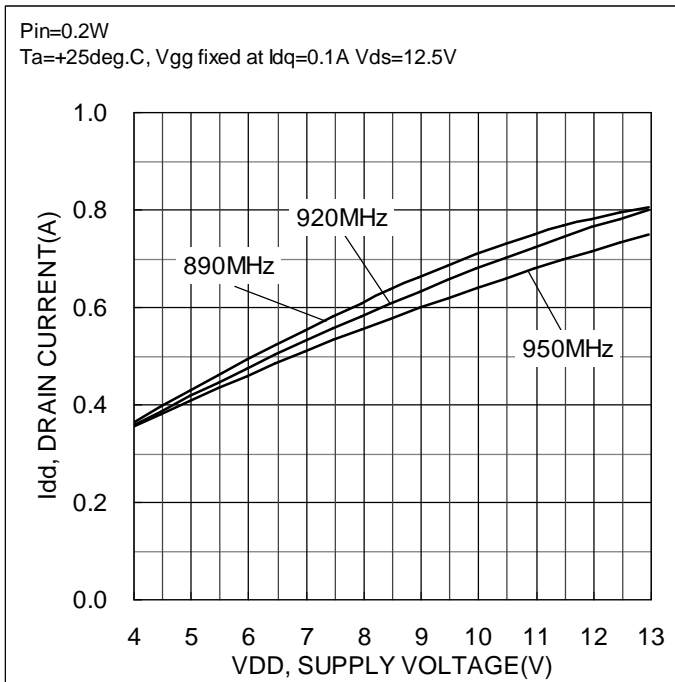

RD04HMS2 single-stage amplifier with f=890-950MHz evaluation board

- AN-900-043-A-

Ta=+25deg. C., Idq=0.1A

890MHz	Vgg	Vdd	Idq	Pin		Pout		Idd	η_D	η_{add}	Gain	I.R.L.
	(V)	(V)	(mA)	(dBm)	(W)	(dBm)	(W)	(A)	(%)	(%)	(dB)	(dB)
	2.66	4.0	0.07	23.0	0.2	29.5	0.9	0.36	62.2	48.4	6.5	-10.5
	2.66	4.5	0.07	23.0	0.2	30.5	1.1	0.40	62.9	51.7	7.5	-10.6
	2.66	5.0	0.08	23.0	0.2	31.3	1.4	0.43	63.3	54.0	8.3	-10.7
	2.66	5.5	0.08	23.0	0.2	32.1	1.6	0.46	63.6	55.7	9.1	-10.8
	2.66	6.0	0.08	23.0	0.2	32.7	1.9	0.49	63.9	57.1	9.7	-10.9
	2.66	6.5	0.08	23.0	0.2	33.4	2.2	0.52	64.2	58.3	10.4	-10.9
	2.66	7.0	0.08	23.0	0.2	33.9	2.5	0.55	64.1	58.9	10.9	-11.0
	2.66	7.5	0.08	23.0	0.2	34.4	2.8	0.58	63.8	59.2	11.4	-11.0
	2.66	8.0	0.09	23.0	0.2	34.9	3.1	0.61	63.7	59.6	11.9	-11.0
	2.66	8.5	0.09	23.0	0.2	35.3	3.4	0.64	63.2	59.5	12.3	-11.0
	2.66	9.0	0.09	23.0	0.2	35.7	3.7	0.66	62.8	59.4	12.7	-11.0
	2.66	9.5	0.09	23.0	0.2	36.1	4.0	0.69	62.2	59.1	13.1	-10.9
	2.66	10.0	0.09	23.0	0.2	36.4	4.3	0.71	61.6	58.7	13.4	-10.9
	2.66	10.5	0.10	23.0	0.2	36.7	4.6	0.73	60.7	58.1	13.7	-10.8
	2.66	11.0	0.10	23.0	0.2	36.9	4.9	0.75	59.8	57.3	13.9	-10.7
	2.66	11.5	0.10	23.0	0.2	37.1	5.2	0.77	58.9	56.6	14.1	-10.6
	2.66	12.0	0.10	23.0	0.2	37.3	5.4	0.78	57.8	55.7	14.3	-10.5
	2.66	12.5	0.11	23.0	0.2	37.5	5.6	0.80	56.6	54.5	14.5	-10.4
	2.66	13.0	0.11	23.0	0.2	37.6	5.8	0.81	55.2	53.3	14.6	-10.2

920MHz	Vgg	Vdd	Idq	Pin		Pout		Idd	η_D	η_{add}	Gain	I.R.L.
	(V)	(V)	(mA)	(dBm)	(W)	(dBm)	(W)	(A)	(%)	(%)	(dB)	(dB)
	2.66	4.0	0.07	23.0	0.2	29.2	0.8	0.36	58.8	44.8	6.2	-23.4
	2.66	4.5	0.07	23.0	0.2	30.2	1.0	0.39	59.9	48.4	7.2	-24.1
	2.66	5.0	0.08	23.0	0.2	31.0	1.3	0.42	60.8	51.2	8.0	-24.6
	2.66	5.5	0.08	23.0	0.2	31.8	1.5	0.45	61.4	53.2	8.8	-25.1
	2.66	6.0	0.08	23.0	0.2	32.4	1.8	0.47	61.9	54.9	9.5	-25.4
	2.66	6.5	0.08	23.0	0.2	33.1	2.0	0.50	62.6	56.5	10.1	-25.7
	2.66	7.0	0.08	23.0	0.2	33.7	2.3	0.53	62.9	57.5	10.7	-25.9
	2.66	7.5	0.08	23.0	0.2	34.2	2.6	0.56	63.2	58.3	11.2	-26.1
	2.66	8.0	0.09	23.0	0.2	34.7	2.9	0.58	63.3	59.0	11.7	-26.2
	2.66	8.5	0.09	23.0	0.2	35.1	3.3	0.61	63.4	59.5	12.1	-26.3
	2.66	9.0	0.09	23.0	0.2	35.6	3.6	0.63	63.3	59.8	12.5	-26.4
	2.66	9.5	0.09	23.0	0.2	35.9	3.9	0.66	63.2	60.0	12.9	-26.5
	2.66	10.0	0.09	23.0	0.2	36.3	4.3	0.68	63.1	60.1	13.3	-26.6
	2.66	10.5	0.10	23.0	0.2	36.6	4.6	0.70	62.8	60.1	13.6	-26.6
	2.66	11.0	0.10	23.0	0.2	36.9	4.9	0.72	62.4	59.9	13.9	-26.7
	2.66	11.5	0.10	23.0	0.2	37.2	5.3	0.74	62.0	59.6	14.2	-26.7
	2.66	12.0	0.10	23.0	0.2	37.5	5.6	0.76	61.4	59.2	14.5	-26.7
	2.66	12.5	0.11	23.0	0.2	37.7	5.9	0.78	60.9	58.8	14.7	-26.7
	2.66	13.0	0.11	23.0	0.2	38.0	6.2	0.80	60.2	58.3	14.9	-26.7

RD04HMS2 single-stage amplifier with f=890-950MHz evaluation board

- AN-900-043-A-

950MHz	V _{gg} (V)	V _{dd} (V)	I _{dq} (mA)	Pin (dBm) (W)		Pout (dBm) (W)		I _{dd} (A)	η _D (%)	η _{add} (%)	Gain (dB)	I.R.L. (dB)
	2.66	4.0	0.07	23.0	0.2	28.9	0.8	0.35	55.1	40.9	5.9	-11.0
	2.66	4.5	0.07	23.0	0.2	29.8	1.0	0.38	56.4	44.8	6.9	-10.9
	2.66	5.0	0.08	23.0	0.2	30.7	1.2	0.41	57.3	47.6	7.7	-10.8
	2.66	5.5	0.08	23.0	0.2	31.4	1.4	0.44	58.1	49.7	8.4	-10.7
	2.66	6.0	0.08	23.0	0.2	32.1	1.6	0.46	59.1	51.8	9.1	-10.6
	2.66	6.5	0.08	23.0	0.2	32.7	1.9	0.48	59.6	53.3	9.7	-10.6
	2.66	7.0	0.08	23.0	0.2	33.3	2.1	0.51	60.2	54.6	10.3	-10.5
	2.66	7.5	0.08	23.0	0.2	33.8	2.4	0.53	60.6	55.6	10.8	-10.5
	2.66	8.0	0.09	23.0	0.2	34.3	2.7	0.55	60.9	56.4	11.3	-10.5
	2.66	8.5	0.09	23.0	0.2	34.8	3.0	0.58	61.3	57.3	11.8	-10.4
	2.66	9.0	0.09	23.0	0.2	35.2	3.3	0.60	61.4	57.7	12.2	-10.4
	2.66	9.5	0.09	23.0	0.2	35.6	3.6	0.62	61.5	58.1	12.6	-10.4
	2.66	10.0	0.09	23.0	0.2	35.9	3.9	0.64	61.6	58.5	13.0	-10.4
	2.66	10.5	0.10	23.0	0.2	36.3	4.2	0.66	61.4	58.5	13.3	-10.5
	2.66	11.0	0.10	23.0	0.2	36.6	4.6	0.68	61.3	58.6	13.6	-10.5
	2.66	11.5	0.10	23.0	0.2	36.9	4.9	0.70	61.1	58.6	13.9	-10.5
	2.66	12.0	0.10	23.0	0.2	37.2	5.2	0.72	60.9	58.6	14.2	-10.6
	2.66	12.5	0.11	23.0	0.2	37.4	5.5	0.73	60.5	58.3	14.4	-10.7
	2.66	13.0	0.11	23.0	0.2	37.7	5.8	0.75	60.1	58.1	14.7	-10.7