

APPLICATION NOTE

Document NO. AN-UHF-114-A

Date : 30th Sep. 2010

Rev. date : 28th Feb. 2011

Prepared : H.Sakairi

K.Mori

Confirmed : T.Okawa

(Taking charge of Silicon RF by
MIYOSHI Electronics)

SUBJECT: RD04HMS2 single-stage amplifier with f=380-470MHz evaluation board

Features:

- The evaluation board for RD04HMS2
- Frequency: 380-470MHz
- Typical input power: 0.2W, Digital Modulation*
*Modulation: $\pi/4$ DPQSK, 18kbps, $\alpha=0.35$, Channel-Band-Width=18KHz, Channel-Spacing=25KHz
- Typical output power: 5.5W @ $V_{ds}=12.5V$, 3.3W @ $V_{ds}=9.1V$
- Typical adjacent channel power ratio: -42dBc
@output power=28dBm, Power gain=16dB, $V_{ds}=9.1V$
- Quiescent Current: 75mA
- Operating Current: 0.7A
- Surface-mounted RF power amplifier structure

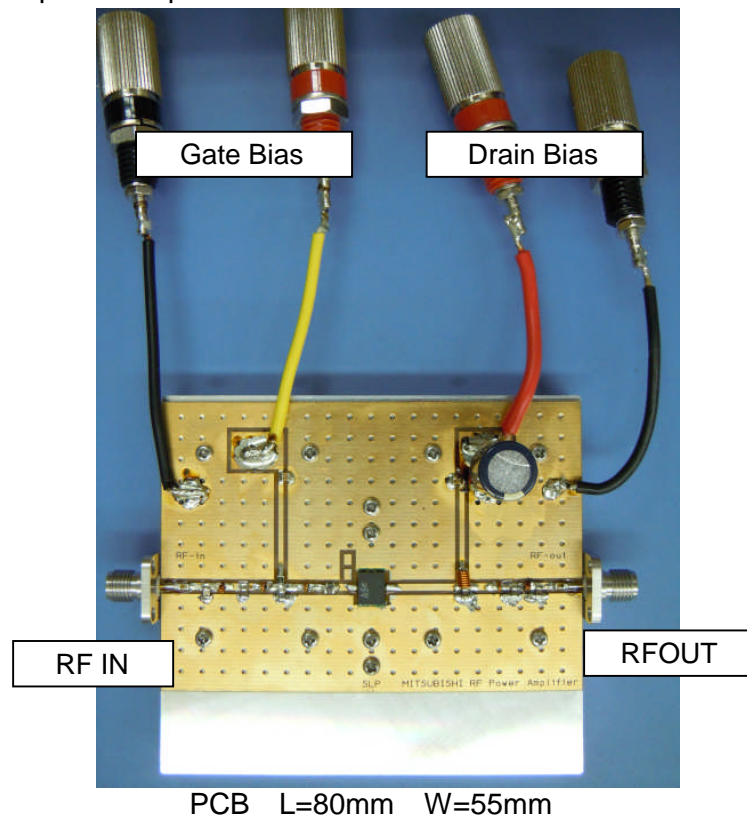

Contents

	Page
1. Equivalent Circuitry -----	3
2. PCB Layout -----	4
3. Component List and Standard Deliverable -----	5
4. Thermal Design of Heat Sink -----	6
5. Typical RF Characteristics -----	7
5-1. Frequency vs. (Vds=12.5V, Pin=23dBm) -----	7
5-2. RF Power vs. (Vds=12.5V) -----	8
5-3. Drain Quiescent Current vs. (Vds=12.5V, Pin=23dBm) -----	12
5-4. Drain Quiescent Current vs. (Vds=12.5V, Pin=11.5dBm) ---	14
5-5. Input Power vs. (Vds=12.5V, Idq=50/75/100/125/mA) -----	16
5-6. DC Power Supply vs. (Idq=0.075A, Pin=23dBm) -----	17
5-7. DC Power Supply vs. (Idq=0.075A, Pin=11.5dBm) -----	19
5-8. Frequency vs. (Vds=9.1V, Pin=23dBm) -----	21
5-9. RF Power vs. (Vds=9.1V) -----	22
5-10. Drain Quiescent Current vs. (Vds=9.1V, Pin=23dBm) -----	26
5-11. Drain Quiescent Current vs. (Vds=9.1V, Pin=11.5dBm) -----	28
5-12. Input Power vs. (Vds=9.1V, Idq=50/75/100/125/mA) -----	30

1. Equivalent Circuitry

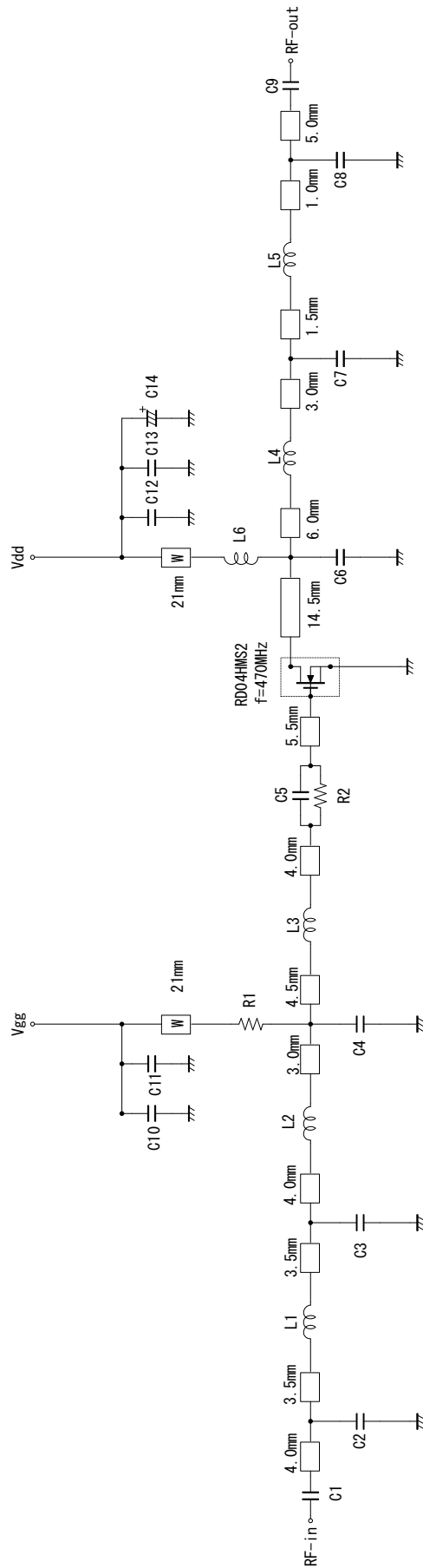

Note: Board material I - Glass-Epoxy Substrate
 Micro strip line width=1.3mm/500HM, er: 4.8, t=0.8mm
 W: line width=1.0mm

RD04HMS2 single-stage amplifier with f=380-470MHz evaluation board

- AN-UHF-114-A-

2. PCB Layout

BOARD OUTLINE: 80.0*55.0(mm)

MATERIAL : FR-4<R1705>

THICKNESS : 0.8(mm)

TOP VIEW

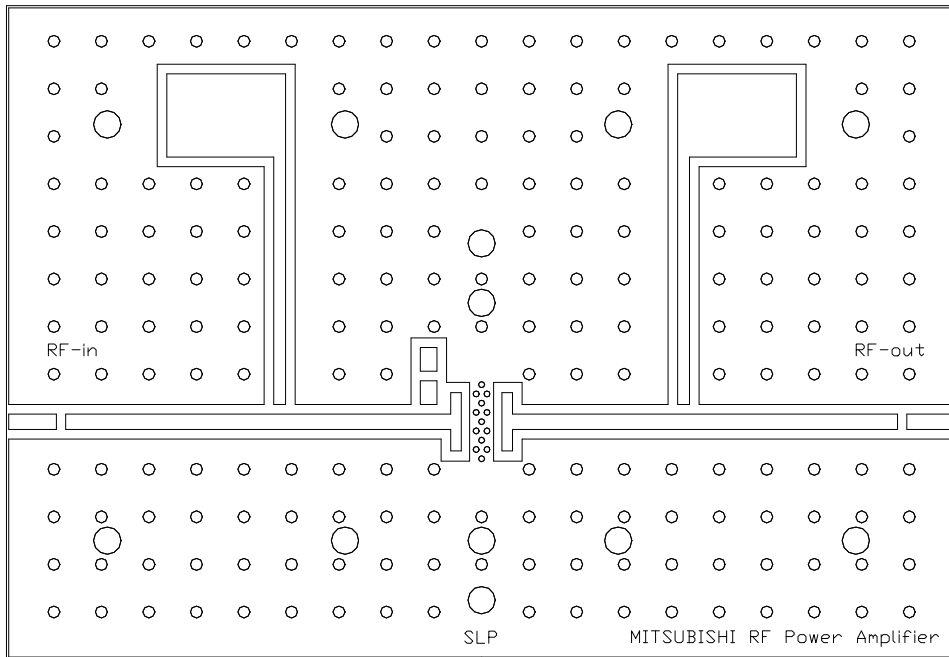

TOP VIEW (Parts mounting)

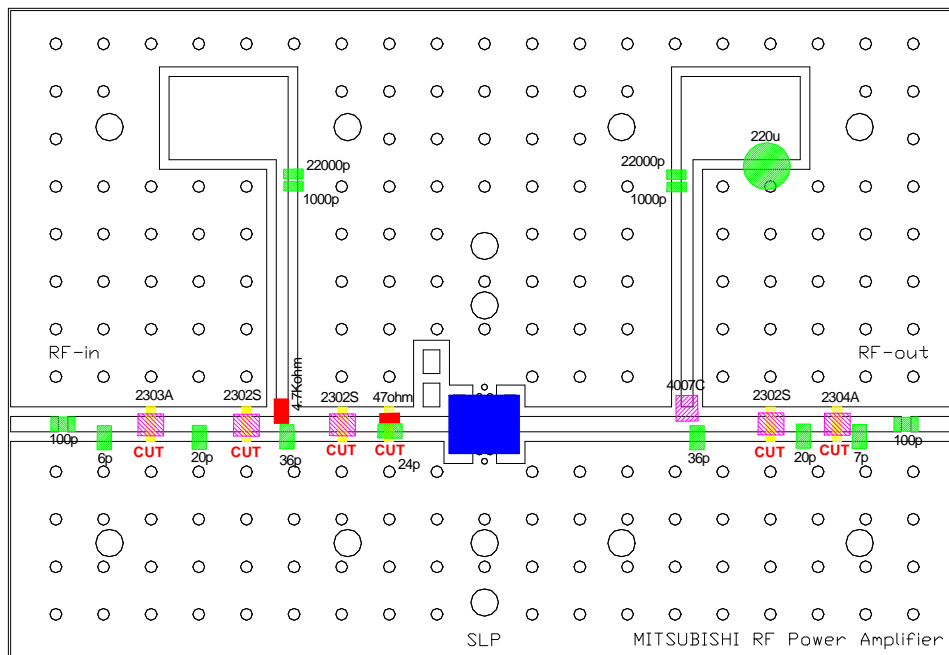

3. Component List and Standard Deliverable

- Component List

No.	Description	P/N	Qty	Manufacturer
Tr	MOSFET	RD04HMS2	1	Mitsubishi Electric Corporation
C 1	100 pF 2012 50V	GRM2162C1H101JA01D	1	MURATA MANUFACTURING CO.
C 2	6 pF 2012 50V	GRM2162C1H6R0JZ01D	1	MURATA MANUFACTURING CO.
C 3	20 pF 2012 50V	GRM2162C1H200JZ01D	1	MURATA MANUFACTURING CO.
C 4	36 pF 2012 50V	GRM2162C1H360JZ01D	1	MURATA MANUFACTURING CO.
C 5	24 pF 2012 50V	GRM2162C1H240JZ01D	1	MURATA MANUFACTURING CO.
C 6	36 pF 2012 50V	GRM2162C1H360JZ01D	1	MURATA MANUFACTURING CO.
C 7	20 pF 2012 50V	GRM2162C1H200JZ01D	1	MURATA MANUFACTURING CO.
C 8	7 pF 2012 50V	GRM2162C1H7R0JZ01D	1	MURATA MANUFACTURING CO.
C 9	100 pF 2012 50V	GRM2162C1H101JA01D	1	MURATA MANUFACTURING CO.
C 10	1000 pF 1608 50V	GRM188R11H102KA01E	1	MURATA MANUFACTURING CO.
C 11	22000 pF 1608 50V	GRM188R11H223KA01E	1	MURATA MANUFACTURING CO.
C 12	1000 pF 1608 50V	GRM188R11H102KA01E	1	MURATA MANUFACTURING CO.
C 13	22000 pF 1608 50V	GRM188R11H223KA01E	1	MURATA MANUFACTURING CO.
C 14	220 uF 35V	EEUF1V221	1	Panasonic Corporation
L 1	12 nH * Diameter: Wire=0.23mm Inside=1.1mm T/N of coils=3		1	YC CORPORATION Co.,Ltd.
L 2	8 nH * Diameter: Wire=0.23mm Inside=1.1mm T/N of coils=2		1	YC CORPORATION Co.,Ltd.
L 3	8 nH * Diameter: Wire=0.23mm Inside=1.1mm T/N of coils=2		1	YC CORPORATION Co.,Ltd.
L 4	8 nH * Diameter: Wire=0.23mm Inside=1.1mm T/N of coils=2		1	YC CORPORATION Co.,Ltd.
L 5	16 nH * Diameter: Wire=0.23mm Inside=1.1mm T/N of coils=4		1	YC CORPORATION Co.,Ltd.
L 6	37 nH * Diameter: Wire=0.4mm Inside=1.6mm T/N of coils=7		1	YC CORPORATION Co.,Ltd.
R 1	4.7K ohm 2012	RPC10T472J	1	TAIYOSHA ELECTRIC CO.
R 2	47 ohm 1608	RPC05N470J	1	TAIYOSHA ELECTRIC CO.
Pb	PCB	MS3A0166	1	Homebuilt
Rc	SMA female connector	HRM-300-118S	2	HIROSE ELECTRIC CO.,LTD
Bc 1	Bias connector red color	TM-605R	2	MSK Corporation
Bc 2	Bias connector black color	TM-605B	2	MSK Corporation
Pe	Aluminum pedestal		1	Homebuilt
	Conducting wire		4	Homebuilt
	Screw M2		16	-

* Inductor of Rolling Coil measurement condition : f=100MHz

- Standard Deliverable

TYPE1	Evaluation Board assembled with all the component
TYPE2	PCB (raw board)

4. Thermal Design of Heat Sink

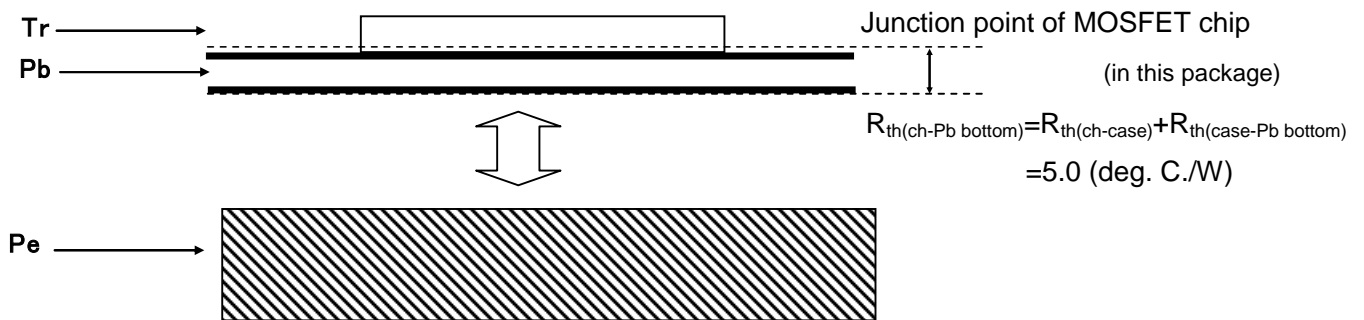

$$T_{ch(\Delta)} = (P_{out}/\text{Efficiency} - P_{out} + P_{in}) \times R_{th(ch-Pb\ bottom)} = (4W/50\% - 4W + 0.2) \times 5.0 = 21 \text{ (deg. C.)}$$

Also, operating T_j (" $T_{j(op)}$ ") = 120 (deg. C.), in case of RD series that $T_{ch(max)} = 150$ (deg. C.)

Therefore $T_{Pb\ bottom-air}$ as delta temperature between Pb bottom and the ambient 60 deg. C.

$$T_{Pb\ bottom-air} = "T_{j(op)}" - T_{ch(\Delta)} - T_{a(60\text{deg.C.})} = 120 - 21 - 60 = 39 \text{ (deg. C.)}$$

In terms of long-term reliability, " $T_{j(op)}$ " has to be kept less than 120 deg. C. i.e. $T_{Pb\ bottom-air}$ has to be less than 39 deg. C..

The thermal resistance of the heat sink to border it:

$$R_{th(Pb\ bottom-air)} = T_{Pb\ bottom-air} / (P_{out}/\text{Efficiency} - P_{out} + P_{in}) = 39 / (4W/50\% - 4W + 0.2) = 9.3 \text{ (deg. C./W)}$$

Therefore

it is preferable that the thermal resistance of the heat sink is much smaller than 9.3 deg. C./W.

5. Typical Performance

5-1. Frequency vs.

OUTPUT POWER, POWER GAIN, DRAIN EFFICIENCY, DRAIN CURRENT and INPUT RETURN LOSS

(Vds=12.5V, Pin=23dBm)

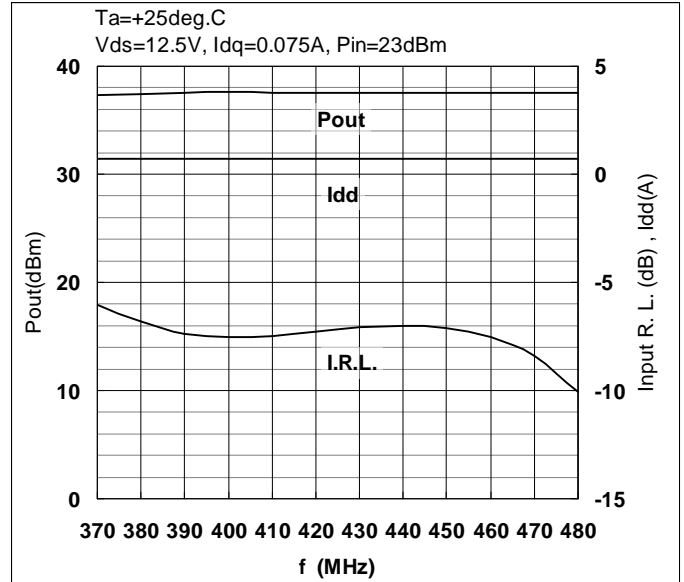
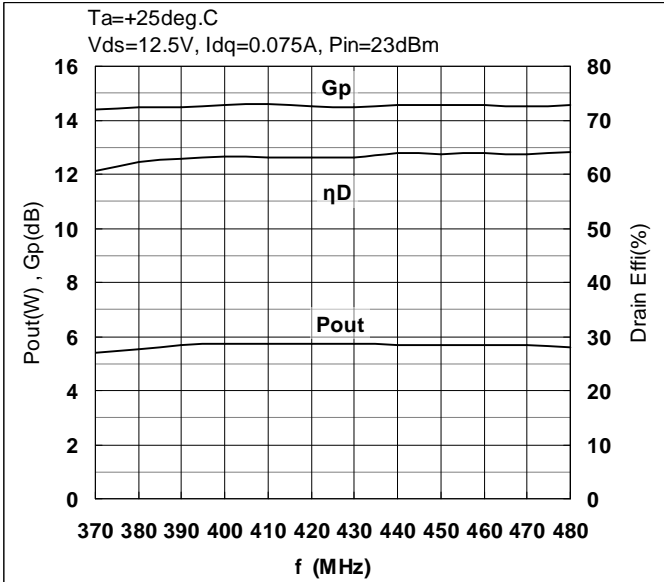

Ta=+25deg. C., Vds=12.5V, Idq=0.075A, Pin=23dBm

Freq. (MHz)	Vgg (V)	Pin (dBm)	Pin (W)	Pout (dBm)	Pout (W)	Gp (dB)	ID(RF) (A)	ηadd (%)	ηD (%)	I.R.L. (dB)
370	2.63	22.9	0.2	37.3	5.4	14.4	0.71	58.3	60.5	-6.0
380	2.63	23.0	0.2	37.4	5.5	14.5	0.71	60.0	62.2	-6.8
390	2.63	23.1	0.2	37.6	5.7	14.5	0.73	60.7	62.9	-7.4
400	2.63	23.0	0.2	37.6	5.7	14.5	0.73	61.0	63.2	-7.5
410	2.63	23.0	0.2	37.6	5.7	14.6	0.73	60.9	63.1	-7.5
420	2.63	23.0	0.2	37.6	5.7	14.5	0.73	60.8	63.1	-7.3
430	2.63	23.1	0.2	37.6	5.7	14.5	0.73	60.8	63.1	-7.1
440	2.63	23.0	0.2	37.6	5.7	14.5	0.71	61.6	63.8	-7.0
450	2.63	23.0	0.2	37.5	5.7	14.6	0.71	61.5	63.7	-7.1
460	2.63	23.0	0.2	37.6	5.7	14.5	0.71	61.6	63.8	-7.5
470	2.63	23.0	0.2	37.5	5.7	14.5	0.71	61.4	63.7	-8.4
480	2.63	22.9	0.2	37.5	5.6	14.5	0.70	61.9	64.1	-10.0

Note: Unless otherwise specified, input signal is setting modulation with the following condition.

Modulation; π/4DPQSK, 18kbps, α=0.35, Channel-Band-Width=18KHz, Channel-Spacing=25KHz

5-2. RF Power vs.

INPUT POWER (Vds=12.5V)

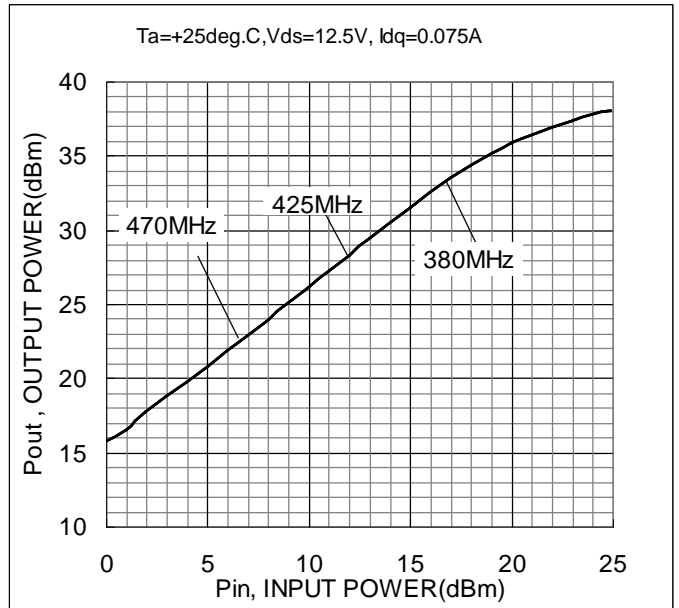
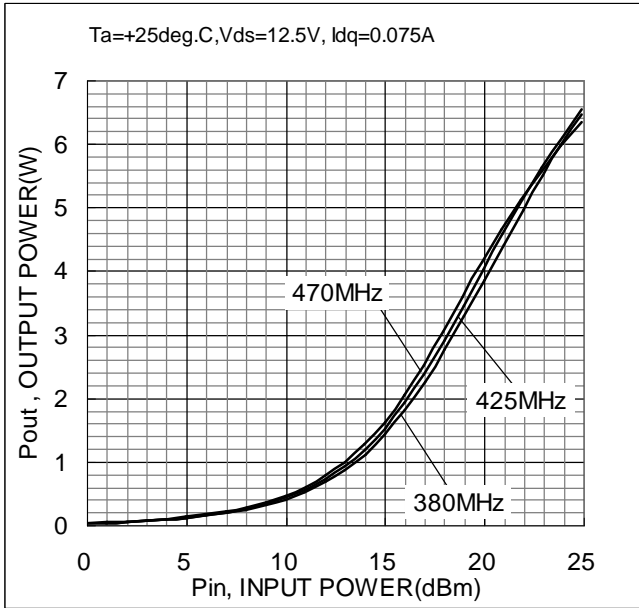

POWER GAIN and +/- ADJACENT CHANNEL POWER (Vds=12.5V)

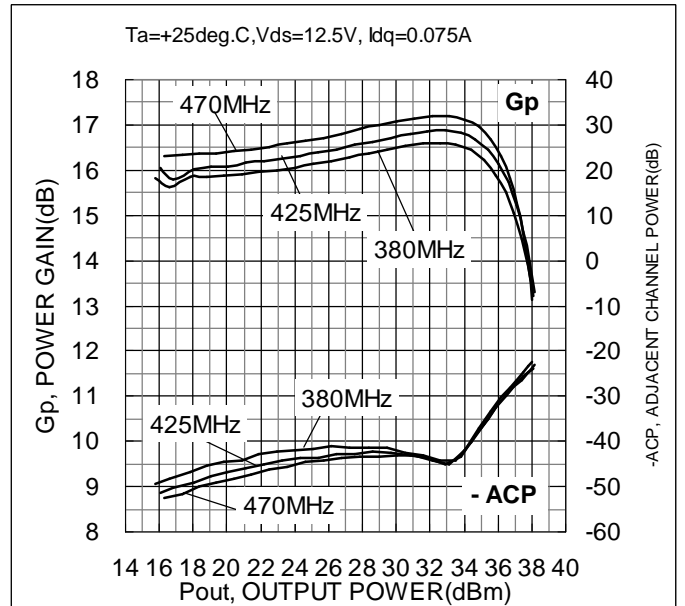
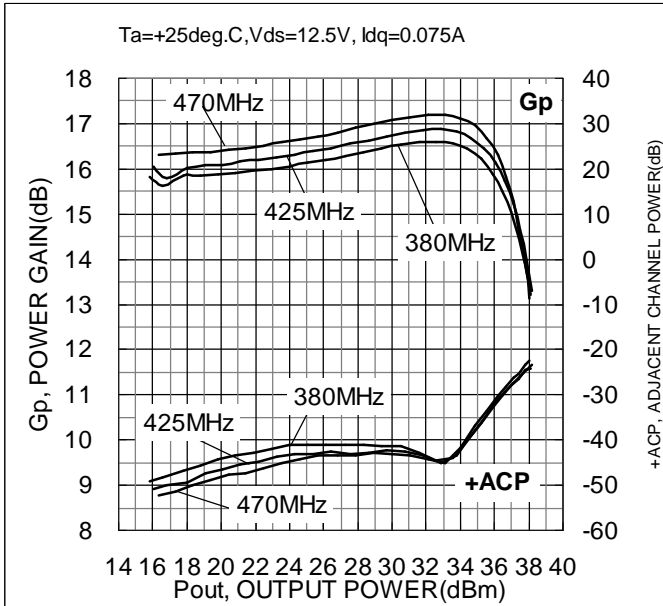

Note: Unless otherwise specified, input signal is setting modulation with the following condition.

Modulation; $\pi/4$ DPQSK, 18kbps, $\alpha=0.35$, Channel-Band-Width=18KHz, Channel-Spacing=25KHz

DRAIN EFFICIENCY (Vds=12.5V)

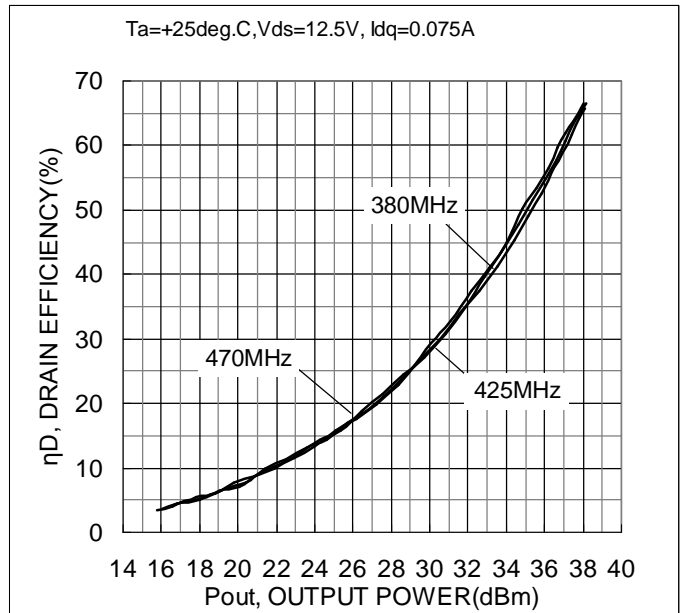
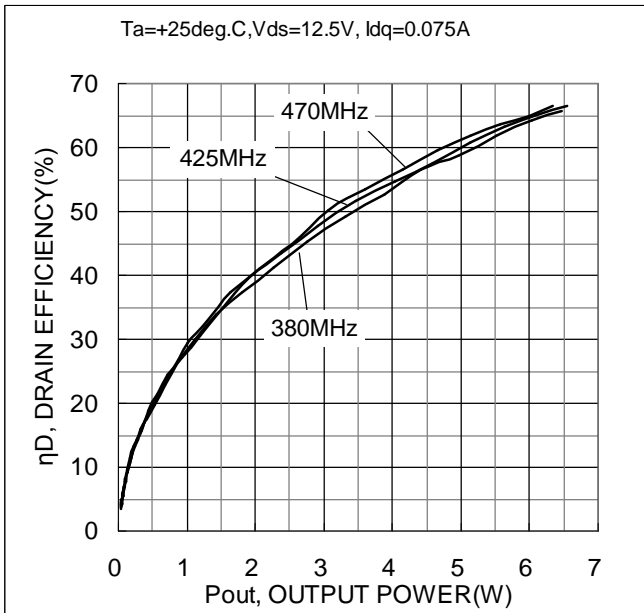

DRAIN CURRENT (Vds=12.5V)

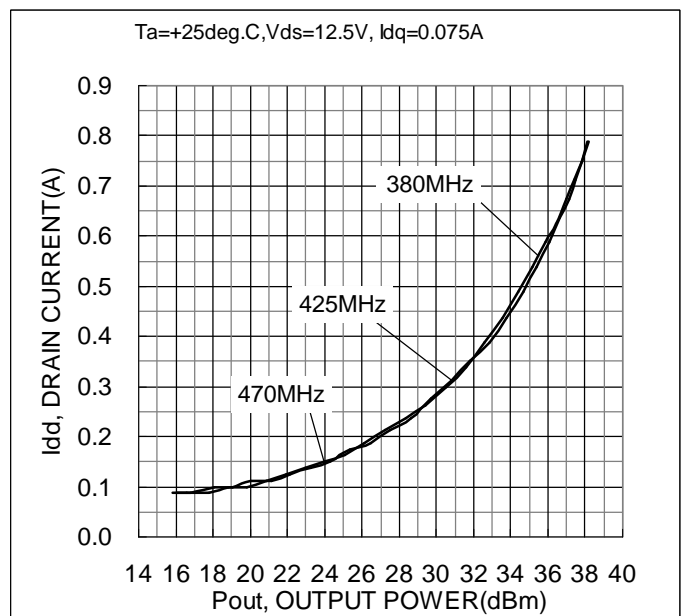
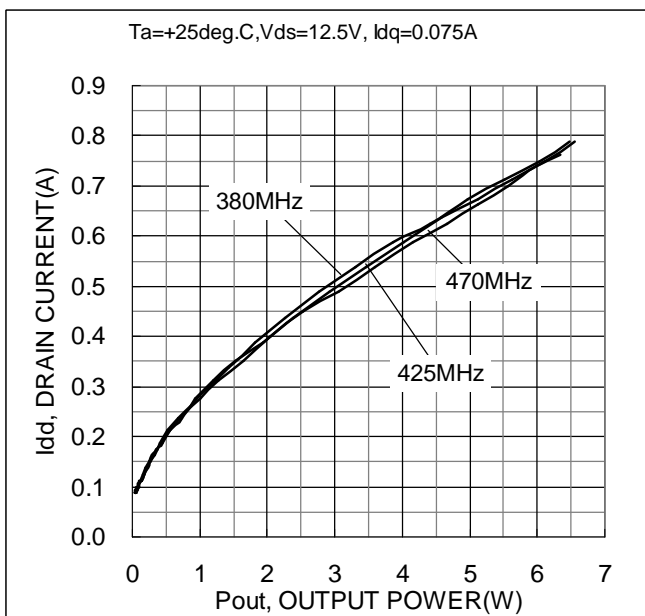

Note: Unless otherwise specified, input signal is setting modulation with the following condition.

Modulation; $\pi/4$ DPSK, 18kbps, $\alpha=0.35$, Channel-Band-Width=18KHz, Channel-Spacing=25KHz

INPUT RETURN LOSS (Vds=12.5V)

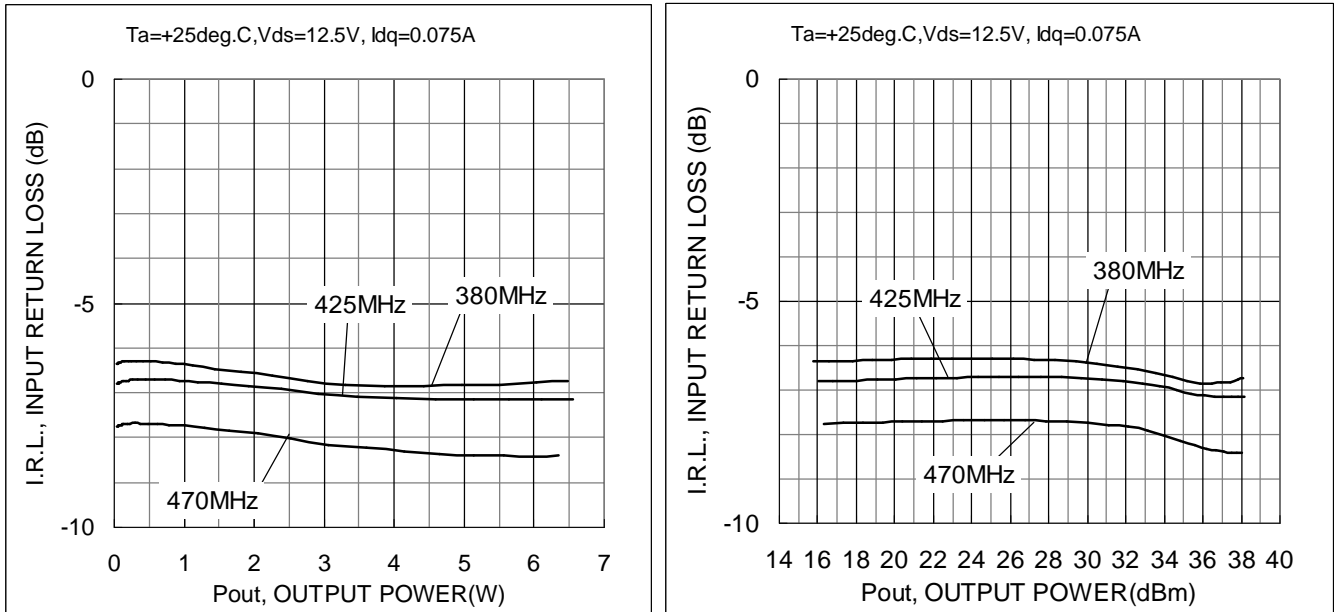

Ta=+25deg. C., Vds=12.5V, Idq=0.075A

380MHz	Vgg	Pin		Pout		Gp	ID(RF)	η_{add}	η_D	I.R.L.	+ACP	-ACP
	(V)	(dBm)	(W)	(dBm)	(W)	(dB)	(A)	(%)	(%)	(dB)	(dB)	(dB)
	2.63	0.0	0.00	15.8	0.0	15.8	0.09	3.4	3.4	-6.4	-49.1	-49.4
	2.63	0.9	0.00	16.6	0.0	15.6	0.09	4.0	4.1	-6.3	-48.3	-48.2
	2.63	1.9	0.00	17.8	0.1	15.9	0.09	5.3	5.5	-6.3	-46.7	-46.8
	2.63	2.9	0.00	18.8	0.1	15.9	0.10	5.9	6.1	-6.3	-45.6	-45.5
	2.63	3.9	0.00	19.8	0.1	15.9	0.10	7.5	7.7	-6.3	-44.3	-44.5
	2.63	4.9	0.00	20.9	0.1	15.9	0.11	8.4	8.6	-6.3	-43.5	-44.2
	2.63	5.9	0.00	21.9	0.2	16.0	0.13	9.7	9.9	-6.3	-42.7	-42.8
	2.63	7.0	0.00	23.0	0.2	16.0	0.14	11.1	11.4	-6.3	-42.1	-42.2
	2.63	7.9	0.01	24.0	0.3	16.0	0.15	13.0	13.4	-6.3	-41.2	-41.9
	2.63	9.0	0.01	25.1	0.3	16.1	0.16	15.5	15.8	-6.3	-41.1	-41.6
	2.63	10.0	0.01	26.2	0.4	16.2	0.19	17.1	17.5	-6.3	-41.2	-41.2
	2.63	11.0	0.01	27.2	0.5	16.3	0.21	19.4	19.8	-6.3	-41.2	-41.4
	2.63	12.0	0.02	28.3	0.7	16.4	0.24	22.4	22.9	-6.3	-41.1	-41.5
	2.63	13.0	0.02	29.4	0.9	16.5	0.26	26.0	26.6	-6.4	-41.4	-41.4
	2.63	14.0	0.02	30.5	1.1	16.5	0.30	29.3	30.0	-6.4	-41.4	-42.4
	2.63	15.0	0.03	31.6	1.4	16.6	0.34	33.2	34.0	-6.5	-42.8	-43.2
	2.63	16.0	0.04	32.6	1.8	16.6	0.39	36.5	37.3	-6.5	-44.4	-44.2
	2.63	17.0	0.05	33.5	2.3	16.6	0.44	40.3	41.2	-6.6	-44.0	-44.1
	2.63	18.0	0.06	34.4	2.8	16.4	0.49	44.3	45.4	-6.7	-40.3	-40.3
	2.63	19.0	0.08	35.2	3.3	16.2	0.54	48.0	49.1	-6.8	-36.2	-36.1
	2.63	20.0	0.10	35.9	3.9	15.9	0.59	51.3	52.7	-6.9	-32.7	-32.5
	2.63	20.9	0.12	36.5	4.4	15.5	0.63	54.9	56.5	-6.9	-30.1	-30.0
	2.63	21.9	0.16	37.0	5.0	15.0	0.68	57.0	58.9	-6.8	-28.0	-27.8
	2.63	22.9	0.20	37.4	5.5	14.5	0.71	59.6	61.8	-6.8	-26.6	-26.3
	2.63	23.9	0.25	37.8	6.0	13.9	0.75	61.6	64.3	-6.8	-24.5	-24.8
	2.63	24.9	0.31	38.1	6.5	13.2	0.79	62.6	65.7	-6.7	-24.1	-23.8

Note: Unless otherwise specified, input signal is setting modulation with the following condition.

Modulation; $\pi/4$ DPQSK, 18kbps, $\alpha=0.35$, Channel-Band-Width=18KHz, Channel-Spacing=25KHz

RD04HMS2 single-stage amplifier with f=380-470MHz evaluation board

- AN-UHF-114-A-

425MHz	V _{gg} (V)	Pin		Pout		G _p (dB)	ID(RF) (A)	η_{add} (%)	η_D (%)	I.R.L. (dB)	+ACP (dB)	-ACP (dB)
		(dBm)	(W)	(dBm)	(W)							
2.63	0.0	0.00	16.1	0.0	16.1	0.09	3.6	3.7	-6.8	-50.9	-51.3	
2.63	1.0	0.00	16.8	0.0	15.8	0.09	4.2	4.4	-6.8	-50.1	-50.3	
2.63	2.0	0.00	18.0	0.1	16.0	0.10	5.0	5.1	-6.8	-49.5	-49.1	
2.63	3.0	0.00	19.1	0.1	16.1	0.10	6.3	6.5	-6.8	-47.3	-47.6	
2.63	4.0	0.00	20.1	0.1	16.1	0.11	7.0	7.2	-6.8	-46.6	-47.0	
2.63	5.0	0.00	21.1	0.1	16.2	0.11	9.0	9.2	-6.7	-45.5	-46.1	
2.63	6.0	0.00	22.2	0.2	16.2	0.13	10.3	10.5	-6.7	-44.7	-45.0	
2.63	7.0	0.01	23.3	0.2	16.2	0.14	12.0	12.3	-6.7	-43.7	-44.3	
2.63	8.0	0.01	24.3	0.3	16.3	0.15	14.0	14.3	-6.7	-43.1	-43.7	
2.63	9.0	0.01	25.4	0.3	16.4	0.18	15.4	15.8	-6.7	-43.0	-43.6	
2.63	10.0	0.01	26.5	0.4	16.5	0.19	18.4	18.8	-6.7	-42.5	-42.9	
2.63	11.0	0.01	27.6	0.6	16.6	0.21	20.9	21.4	-6.7	-43.2	-42.7	
2.63	12.0	0.02	28.6	0.7	16.6	0.24	24.0	24.5	-6.7	-42.7	-42.3	
2.63	13.0	0.02	29.7	0.9	16.7	0.28	26.6	27.1	-6.7	-42.3	-42.6	
2.63	14.0	0.03	30.8	1.2	16.8	0.31	30.0	30.7	-6.8	-42.4	-43.2	
2.63	15.0	0.03	31.8	1.5	16.9	0.35	34.1	34.8	-6.8	-43.5	-43.7	
2.63	16.0	0.04	32.9	1.9	16.9	0.39	38.9	39.7	-6.8	-45.2	-45.1	
2.63	17.0	0.05	33.8	2.4	16.8	0.44	42.6	43.5	-6.9	-43.5	-43.4	
2.63	18.0	0.06	34.6	2.9	16.7	0.49	46.7	47.7	-7.0	-39.2	-38.9	
2.63	18.9	0.08	35.4	3.5	16.5	0.54	50.4	51.6	-7.1	-35.2	-35.2	
2.63	19.9	0.10	36.1	4.0	16.1	0.59	53.5	54.8	-7.1	-31.7	-31.6	
2.63	20.9	0.12	36.6	4.6	15.7	0.64	56.0	57.6	-7.1	-29.3	-29.1	
2.63	21.9	0.15	37.1	5.1	15.2	0.68	59.0	60.8	-7.2	-27.5	-27.1	
2.63	22.9	0.19	37.5	5.6	14.7	0.71	61.1	63.2	-7.2	-25.8	-25.6	
2.63	23.9	0.24	37.9	6.1	14.0	0.75	62.6	65.2	-7.1	-24.4	-24.6	
2.63	24.9	0.31	38.2	6.5	13.3	0.79	63.4	66.5	-7.1	-23.2	-23.1	

470MHz	V _{gg} (V)	Pin		Pout		G _p (dB)	ID(RF) (A)	η_{add} (%)	η_D (%)	I.R.L. (dB)	+ACP (dB)	-ACP (dB)
		(dBm)	(W)	(dBm)	(W)							
2.63	0.0	0.00	16.3	0.0	16.3	0.09	3.8	3.9	-7.8	-52.3	-52.4	
2.63	1.0	0.00	17.3	0.1	16.3	0.09	4.8	4.9	-7.7	-51.5	-51.5	
2.63	2.0	0.00	18.4	0.1	16.4	0.10	5.3	5.5	-7.7	-50.1	-49.9	
2.63	3.0	0.00	19.4	0.1	16.4	0.10	6.8	6.9	-7.7	-48.8	-49.0	
2.63	4.0	0.00	20.4	0.1	16.4	0.11	7.6	7.8	-7.7	-47.8	-48.2	
2.63	5.0	0.00	21.4	0.1	16.5	0.11	9.6	9.8	-7.7	-47.4	-47.3	
2.63	6.0	0.00	22.5	0.2	16.5	0.13	11.1	11.4	-7.7	-46.2	-46.3	
2.63	7.0	0.00	23.6	0.2	16.6	0.14	12.9	13.2	-7.7	-45.0	-45.7	
2.63	8.0	0.01	24.6	0.3	16.7	0.16	14.0	14.3	-7.7	-44.1	-44.5	
2.63	9.0	0.01	25.7	0.4	16.7	0.18	16.6	17.0	-7.7	-43.5	-44.2	
2.63	10.0	0.01	26.8	0.5	16.8	0.20	18.7	19.1	-7.7	-43.4	-43.7	
2.63	11.0	0.01	27.9	0.6	16.9	0.23	21.3	21.8	-7.7	-43.3	-43.4	
2.63	12.0	0.02	29.0	0.8	17.0	0.25	24.6	25.1	-7.7	-42.9	-43.3	
2.63	13.0	0.02	30.0	1.0	17.1	0.28	28.7	29.3	-7.7	-43.0	-43.1	
2.63	14.0	0.02	31.1	1.3	17.1	0.31	32.2	32.9	-7.8	-43.5	-43.2	
2.63	14.9	0.03	32.1	1.6	17.2	0.35	36.7	37.4	-7.8	-44.2	-44.3	
2.63	15.9	0.04	33.1	2.1	17.2	0.40	40.3	41.1	-7.9	-45.2	-45.1	
2.63	16.9	0.05	34.0	2.5	17.1	0.45	44.1	45.0	-8.0	-41.8	-41.8	
2.63	17.9	0.06	34.9	3.1	17.0	0.49	49.2	50.2	-8.2	-36.9	-37.1	
2.63	18.9	0.08	35.6	3.6	16.7	0.54	52.3	53.5	-8.2	-33.5	-33.2	
2.63	19.9	0.10	36.2	4.1	16.3	0.59	55.1	56.5	-8.3	-30.1	-30.2	
2.63	20.8	0.12	36.7	4.7	15.8	0.63	58.0	59.6	-8.4	-28.2	-28.1	
2.63	21.8	0.15	37.1	5.1	15.3	0.66	60.0	61.9	-8.4	-26.2	-26.5	
2.63	22.9	0.19	37.5	5.6	14.6	0.70	61.5	63.7	-8.4	-25.3	-24.8	
2.63	23.9	0.24	37.8	6.0	13.9	0.74	62.2	64.9	-8.4	-23.4	-23.2	
2.63	24.9	0.31	38.0	6.3	13.1	0.76	63.2	66.5	-8.4	-22.4	-22.4	

Note: Unless otherwise specified, input signal is setting modulation with the following condition.

Modulation; $\pi/4$ DPQSK, 18kbps, $\alpha=0.35$, Channel-Band-Width=18KHz, Channel-Spacing=25KHz

5-3. Drain Quiescent Current vs.

OUTPUT POWER and DRAIN EFFICIENCY (Vds=12.5V, Pin=23dBm)

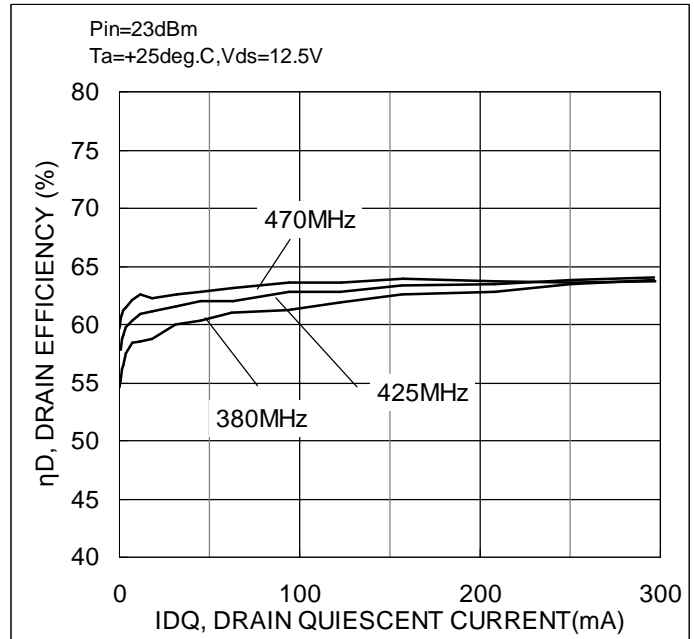
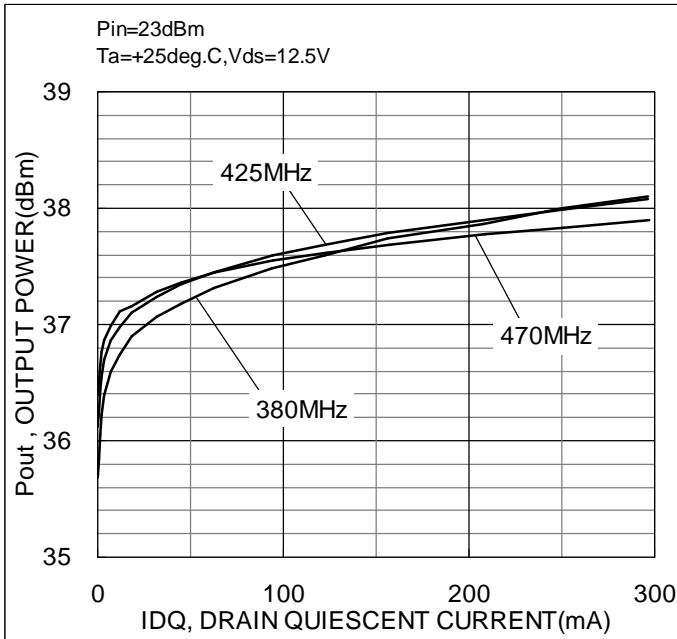

Ta=+25deg. C., Vds=12.5V, Pin=23dBm

380MHz	Vgg		Pin		Pout		Idd	η_D	η_{add}	Gain	I.R.L.
	(V)	(mA)	(dBm)	(W)	(dBm)	(W)					
	2.10	0.2	23.0	0.20	35.7	3.7	0.54	54.6	51.6	12.7	-6.3
	2.15	0.6	23.0	0.20	35.8	3.8	0.55	55.3	52.4	12.8	-6.3
	2.21	1.3	23.0	0.20	36.1	4.0	0.57	56.2	53.4	13.1	-6.4
	2.25	2.3	23.0	0.20	36.2	4.2	0.59	56.6	53.9	13.2	-6.4
	2.30	3.7	23.0	0.20	36.4	4.4	0.61	57.5	54.9	13.4	-6.4
	2.36	7.2	23.0	0.20	36.6	4.6	0.63	58.4	55.9	13.6	-6.5
	2.40	11.7	23.0	0.20	36.7	4.7	0.65	58.5	56.1	13.7	-6.5
	2.45	18.3	23.0	0.20	36.9	4.9	0.67	58.7	56.3	13.9	-6.6
	2.51	31.5	23.0	0.20	37.1	5.1	0.68	60.0	57.7	14.1	-6.6
	2.55	45.0	23.0	0.20	37.2	5.2	0.69	60.4	58.1	14.2	-6.7
	2.60	62.5	23.0	0.20	37.3	5.4	0.71	61.0	58.8	14.3	-6.7
	2.66	93.7	23.0	0.20	37.5	5.6	0.73	61.2	59.0	14.5	-6.8
	2.70	122.7	23.0	0.20	37.6	5.8	0.74	61.9	59.8	14.6	-6.9
	2.75	156.3	23.0	0.20	37.7	5.9	0.76	62.6	60.5	14.7	-6.9
	2.81	207.8	23.0	0.20	37.9	6.1	0.78	62.8	60.7	14.9	-7.0
	2.85	250.2	23.0	0.20	38.0	6.3	0.80	63.5	61.5	15.0	-7.0
	2.90	296.2	23.0	0.20	38.1	6.5	0.81	63.8	61.9	15.1	-7.1

Note: Unless otherwise specified, input signal is setting modulation with the following condition.

Modulation; $\pi/4$ DPQSK, 18kbps, $\alpha=0.35$, Channel-Band-Width=18KHz, Channel-Spacing=25KHz

RD04HMS2 single-stage amplifier with f=380-470MHz evaluation board

- AN-UHF-114-A-

425MHz	V _{gg}	I _{dq}	P _{in}		P _{out}		I _{dd}	η _D	η _{add}	Gain	I.R.L.
	(V)	(mA)	(dBm)	(W)	(dBm)	(W)	(A)	(%)	(%)	(dB)	(dB)
	2.10	0.2	23.0	0.20	36.1	4.1	0.57	57.9	55.1	13.1	-6.7
	2.15	0.5	23.0	0.20	36.3	4.2	0.58	57.9	55.1	13.2	-6.8
	2.21	1.3	23.0	0.20	36.4	4.4	0.60	58.8	56.1	13.4	-6.8
	2.25	2.3	23.0	0.20	36.6	4.5	0.61	59.0	56.4	13.6	-6.9
	2.30	3.7	23.0	0.20	36.7	4.7	0.63	59.8	57.2	13.7	-6.9
	2.36	7.3	23.0	0.20	36.9	4.9	0.64	60.4	57.9	13.9	-6.9
	2.40	11.7	23.0	0.20	37.0	5.0	0.66	60.9	58.4	14.0	-7.0
	2.45	18.4	23.0	0.20	37.1	5.1	0.67	61.2	58.8	14.1	-7.0
	2.51	31.6	23.0	0.20	37.2	5.3	0.69	61.6	59.3	14.2	-7.0
	2.55	45.2	23.0	0.20	37.4	5.4	0.70	62.0	59.7	14.3	-7.1
	2.60	62.9	23.0	0.20	37.5	5.6	0.72	62.0	59.7	14.4	-7.1
	2.66	94.0	23.0	0.20	37.6	5.8	0.73	62.8	60.6	14.6	-7.2
	2.70	122.8	23.0	0.20	37.7	5.9	0.75	62.8	60.7	14.7	-7.2
	2.75	156.5	23.0	0.20	37.8	6.0	0.76	63.3	61.2	14.8	-7.2
	2.81	207.9	23.0	0.20	37.9	6.2	0.78	63.5	61.5	14.9	-7.3
	2.85	250.7	23.0	0.20	38.0	6.3	0.79	63.8	61.7	15.0	-7.3
	2.90	296.7	23.0	0.20	38.1	6.4	0.80	64.0	62.0	15.1	-7.4

470MHz	V _{gg}	I _{dq}	P _{in}		P _{out}		I _{dd}	η _D	η _{add}	Gain	I.R.L.
	(V)	(mA)	(dBm)	(W)	(dBm)	(W)	(A)	(%)	(%)	(dB)	(dB)
	2.10	0.3	23.0	0.20	36.4	4.4	0.58	59.7	57.0	13.4	-7.8
	2.15	0.6	23.0	0.20	36.5	4.5	0.59	60.6	57.9	13.5	-7.9
	2.21	1.4	23.0	0.20	36.7	4.6	0.61	60.9	58.2	13.6	-7.9
	2.25	2.3	23.0	0.20	36.8	4.7	0.62	61.3	58.7	13.8	-8.0
	2.30	3.8	23.0	0.20	36.9	4.9	0.63	61.5	59.0	13.9	-8.0
	2.36	7.4	23.0	0.20	37.0	5.0	0.64	62.2	59.7	14.0	-8.1
	2.40	11.8	23.0	0.20	37.1	5.1	0.66	62.6	60.1	14.1	-8.1
	2.45	18.5	23.0	0.20	37.2	5.2	0.67	62.3	59.9	14.2	-8.2
	2.51	31.7	23.0	0.20	37.3	5.3	0.68	62.6	60.3	14.3	-8.3
	2.55	45.2	23.0	0.20	37.4	5.4	0.69	62.8	60.5	14.3	-8.3
	2.60	63.1	23.0	0.20	37.5	5.6	0.70	63.2	60.9	14.4	-8.4
	2.66	94.3	23.0	0.20	37.6	5.7	0.72	63.6	61.4	14.6	-8.4
	2.70	123.2	23.0	0.20	37.6	5.8	0.73	63.6	61.4	14.6	-8.5
	2.75	157.0	23.0	0.20	37.7	5.9	0.74	63.9	61.7	14.7	-8.5
	2.81	208.2	23.0	0.20	37.8	6.0	0.75	63.8	61.6	14.8	-8.6
	2.85	250.9	23.0	0.20	37.8	6.1	0.76	63.6	61.5	14.9	-8.7
	2.90	297.0	23.0	0.20	37.9	6.2	0.78	63.7	61.6	14.9	-8.7

Note: Unless otherwise specified, input signal is setting modulation with the following condition.

Modulation; π/4DPQSK, 18kbps, α=0.35, Channel-Band-Width=18KHz, Channel-Spacing=25KHz

5-4. Drain Quiescent Current vs.

OUTPUT POWER and DRAIN EFFICIENCY (Vds=12.5V, Pin=11.5dBm)

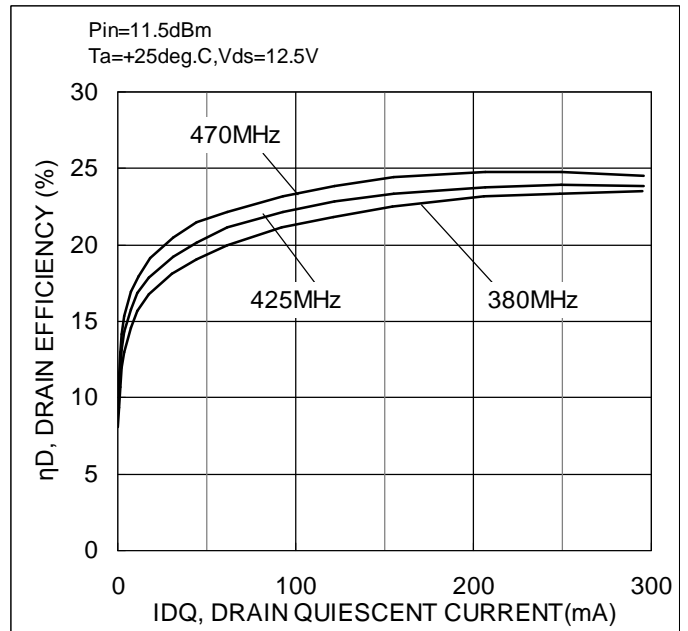
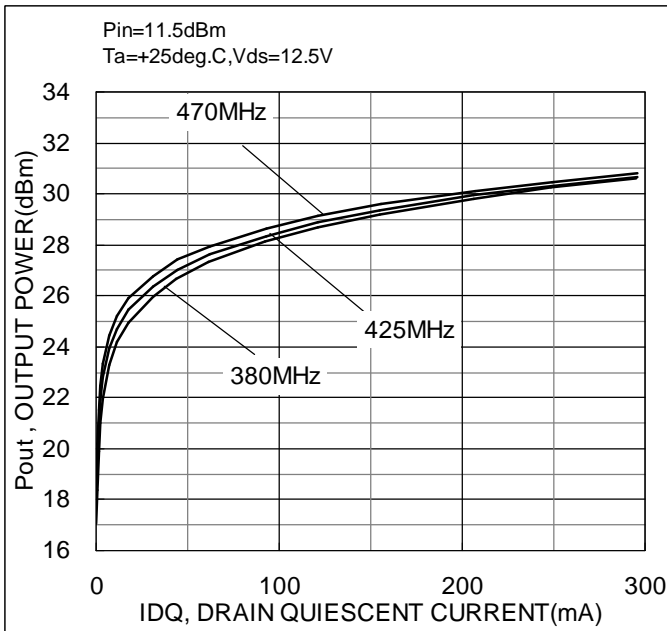

+ / - ADJACENT CHANNEL POWER (Vds=12.5V, Pin=11.5dBm)

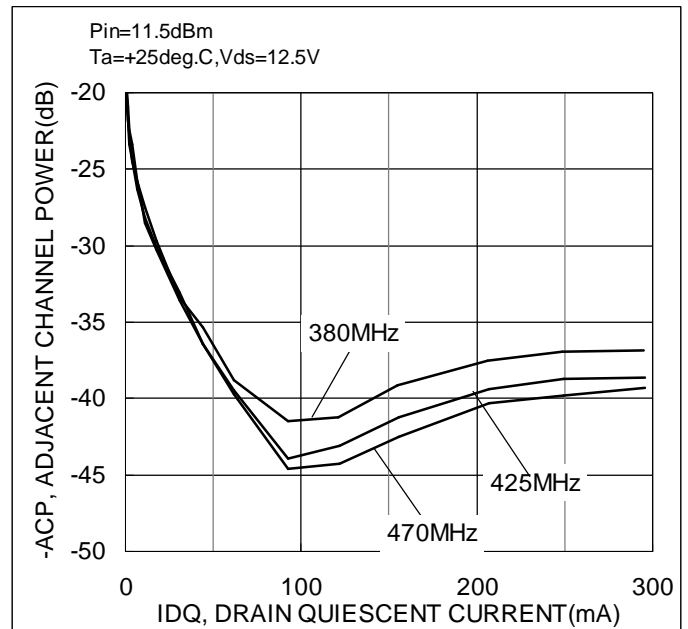
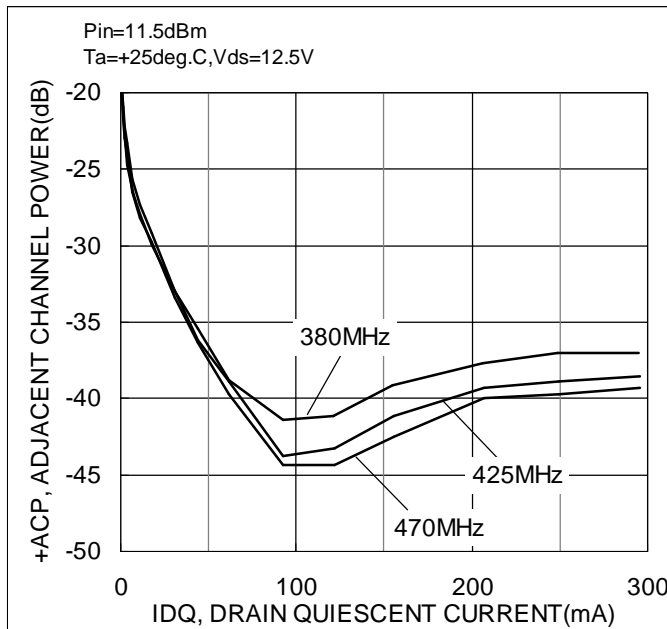

Note: Unless otherwise specified, input signal is setting modulation with the following condition.

Modulation; π/4DPQSK, 18kbps, α=0.35, Channel-Band-Width=18KHz, Channel-Spacing=25KHz

RD04HMS2 single-stage amplifier with f=380-470MHz evaluation board

- AN-UHF-114-A-

Ta=+25deg. C., Vds=12.5V, Pin=11.5dBm

380MHz	V _{gg}	I _{dq}	Pin		P _{out}		I _{dd}	η _D	η _{add}	Gain	I.R.L.	-ACP	+ACP
	(V)	(mA)	(dBm)	(W)	(dBm)	(W)	(A)	(%)	(%)	(dB)	(dB)	(dB)	(dB)
	2.10	0.3	11.5	0.014	17.1	0.1	0.05	8.1	5.8	5.5	-4.9	-18.2	-18.6
	2.15	0.6	11.5	0.014	18.4	0.1	0.06	9.3	7.4	6.9	-4.9	-19.9	-19.7
	2.21	1.2	11.5	0.014	19.9	0.1	0.07	10.7	9.2	8.4	-5.0	-20.9	-21.0
	2.25	2.2	11.5	0.014	21.0	0.1	0.08	12.0	10.6	9.5	-5.1	-22.2	-22.5
	2.30	3.5	11.5	0.014	22.0	0.2	0.10	12.9	11.8	10.5	-5.2	-23.3	-23.4
	2.36	6.9	11.5	0.014	23.3	0.2	0.12	14.6	13.6	11.8	-5.3	-25.7	-25.8
	2.40	11.2	11.5	0.014	24.2	0.3	0.13	15.7	14.8	12.6	-5.5	-27.4	-27.5
	2.45	17.6	11.5	0.014	25.0	0.3	0.15	16.8	16.0	13.4	-5.6	-29.2	-29.7
	2.51	30.8	11.5	0.014	26.0	0.4	0.17	18.1	17.5	14.4	-5.8	-33.0	-33.4
	2.55	44.0	11.5	0.014	26.7	0.5	0.19	19.0	18.5	15.1	-6.0	-35.4	-35.4
	2.60	61.3	11.5	0.014	27.3	0.5	0.22	20.0	19.4	15.8	-6.1	-38.8	-38.8
	2.66	92.2	11.5	0.014	28.1	0.7	0.25	21.2	20.7	16.6	-6.4	-41.4	-41.5
	2.70	121.0	11.5	0.014	28.7	0.7	0.27	21.8	21.4	17.2	-6.6	-41.2	-41.2
	2.75	154.6	11.5	0.014	29.2	0.8	0.29	22.5	22.1	17.7	-6.9	-39.2	-39.2
	2.81	206.0	11.5	0.014	29.8	1.0	0.33	23.1	22.8	18.3	-7.2	-37.7	-37.6
	2.85	248.9	11.5	0.014	30.2	1.1	0.36	23.4	23.1	18.7	-7.4	-37.0	-37.0
	2.90	295.2	11.5	0.014	30.6	1.2	0.39	23.5	23.2	19.1	-7.7	-37.1	-36.8

425MHz	V _{gg}	I _{dq}	Pin		P _{out}		I _{dd}	η _D	η _{add}	Gain	I.R.L.	-ACP	+ACP
	(V)	(mA)	(dBm)	(W)	(dBm)	(W)	(A)	(%)	(%)	(dB)	(dB)	(dB)	(dB)
	2.10	0.2	11.5	0.014	18.4	0.1	0.06	9.5	7.6	6.9	-5.6	-19.5	-19.3
	2.15	0.6	11.5	0.014	19.6	0.1	0.07	10.6	9.0	8.0	-5.7	-20.1	-20.2
	2.21	1.2	11.5	0.014	20.9	0.1	0.08	12.0	10.6	9.4	-5.8	-21.5	-21.8
	2.25	2.2	11.5	0.014	21.9	0.2	0.09	13.2	12.0	10.4	-5.8	-22.6	-22.7
	2.30	3.6	11.5	0.014	22.8	0.2	0.11	14.3	13.3	11.3	-5.9	-24.7	-24.5
	2.36	7.0	11.5	0.014	24.0	0.2	0.13	15.8	14.9	12.4	-6.0	-26.6	-26.1
	2.40	11.2	11.5	0.014	24.7	0.3	0.14	16.8	16.0	13.2	-6.1	-27.9	-28.5
	2.45	17.7	11.5	0.014	25.4	0.3	0.16	17.8	17.1	14.0	-6.2	-30.0	-30.2
	2.51	31.0	11.5	0.014	26.4	0.4	0.18	19.2	18.6	14.9	-6.3	-33.0	-33.5
	2.55	44.3	11.5	0.014	27.0	0.5	0.20	20.2	19.6	15.5	-6.4	-36.2	-36.5
	2.60	61.7	11.5	0.014	27.6	0.6	0.22	21.1	20.6	16.1	-6.6	-38.9	-39.4
	2.66	92.6	11.5	0.014	28.4	0.7	0.25	22.1	21.7	16.9	-6.8	-43.8	-43.9
	2.70	121.4	11.5	0.014	28.9	0.8	0.27	22.8	22.4	17.4	-6.9	-43.3	-43.1
	2.75	155.2	11.5	0.014	29.4	0.9	0.30	23.3	22.9	17.8	-7.1	-41.2	-41.3
	2.81	206.7	11.5	0.014	29.9	1.0	0.33	23.8	23.4	18.4	-7.3	-39.3	-39.4
	2.85	249.5	11.5	0.014	30.3	1.1	0.36	23.9	23.6	18.8	-7.5	-38.9	-38.7
	2.90	295.7	11.5	0.014	30.7	1.2	0.39	23.8	23.5	19.2	-7.6	-38.6	-38.6

470MHz	V _{gg}	I _{dq}	Pin		P _{out}		I _{dd}	η _D	η _{add}	Gain	I.R.L.	-ACP	+ACP
	(V)	(mA)	(dBm)	(W)	(dBm)	(W)	(A)	(%)	(%)	(dB)	(dB)	(dB)	(dB)
	2.10	0.4	11.5	0.014	19.2	0.1	0.06	10.4	8.7	7.7	-6.2	-19.3	-19.5
	2.15	0.6	11.5	0.014	20.2	0.1	0.07	11.4	9.8	8.7	-6.3	-20.2	-20.8
	2.21	1.3	11.5	0.014	21.5	0.1	0.09	13.0	11.7	10.1	-6.4	-21.8	-21.8
	2.25	2.2	11.5	0.014	22.5	0.2	0.10	14.2	13.0	11.0	-6.5	-22.9	-23.3
	2.30	3.6	11.5	0.014	23.3	0.2	0.11	15.3	14.3	11.9	-6.6	-24.1	-24.4
	2.36	6.9	11.5	0.014	24.5	0.3	0.13	16.9	16.1	13.0	-6.7	-26.5	-26.3
	2.40	11.2	11.5	0.014	25.2	0.3	0.15	18.0	17.2	13.7	-6.8	-28.2	-28.1
	2.45	17.8	11.5	0.014	25.9	0.4	0.16	19.1	18.4	14.4	-7.0	-29.8	-30.1
	2.51	30.9	11.5	0.014	26.8	0.5	0.19	20.5	19.9	15.3	-7.2	-33.4	-33.1
	2.55	44.3	11.5	0.014	27.4	0.6	0.21	21.4	20.9	15.9	-7.4	-36.4	-36.5
	2.60	61.7	11.5	0.014	27.9	0.6	0.22	22.2	21.7	16.5	-7.5	-39.7	-39.7
	2.66	92.7	11.5	0.014	28.7	0.7	0.25	23.2	22.8	17.2	-7.8	-44.3	-44.6
	2.70	121.5	11.5	0.014	29.1	0.8	0.27	23.9	23.5	17.7	-8.0	-44.3	-44.2
	2.75	155.3	11.5	0.014	29.6	0.9	0.30	24.4	24.0	18.1	-8.2	-42.5	-42.5
	2.81	206.7	11.5	0.014	30.1	1.0	0.33	24.7	24.4	18.6	-8.5	-40.0	-40.3
	2.85	249.5	11.5	0.014	30.5	1.1	0.36	24.7	24.4	19.0	-8.7	-39.7	-39.8
	2.90	295.9	11.5	0.014	30.8	1.2	0.39	24.6	24.3	19.3	-9.0	-39.3	-39.3

Note: Unless otherwise specified, input signal is setting modulation with the following condition.

Modulation; π/4DPQSK, 18kbps, α=0.35, Channel-Band-Width=18KHz, Channel-Spacing=25KHz

5-5. Input Power vs.

OUTPUT POWER and - ADJACENT CHANNEL POWER

(Vds=12.5V, Each Drain Quiescent Current IDQ=50/75/100/125mA)

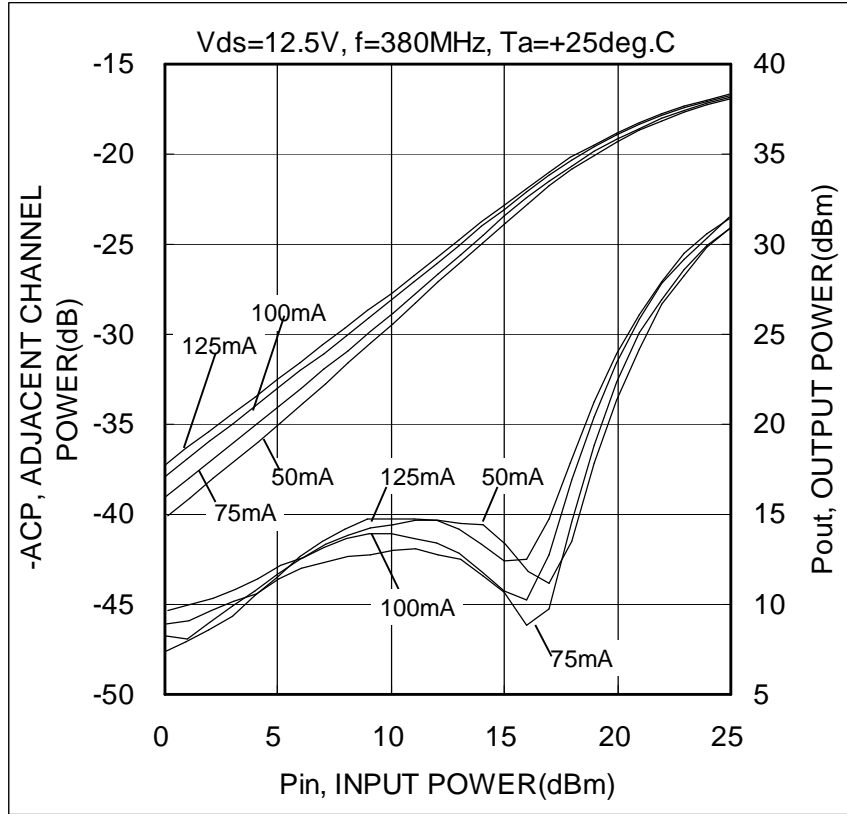

Vds=12.5V, f=380MHz

Idq= 50mA				Idq= 75mA				Idq=100mA				Idq=125mA							
Pin (dBm)	Pout (W)	-ACP (dBm)	-ACP (dB)	Pin (dBm)	Pout (W)	-ACP (dBm)	-ACP (dB)	Pin (dBm)	Pout (W)	-ACP (dBm)	-ACP (dB)	Pin (dBm)	Pout (W)	-ACP (dBm)	-ACP (dB)				
0.1	0.00	14.9	0.03	-45.3	0.1	0.00	0.1	0.00	-46.1	0.0	0.00	17.1	0.05	-46.7	-0.1	0.00	17.7	0.06	-47.6
1.1	0.00	15.9	0.04	-45.0	1.1	0.00	1.1	0.00	-45.9	1.0	0.00	18.1	0.06	-46.9	1.0	0.00	18.6	0.07	-47.1
2.1	0.00	17.0	0.05	-44.6	2.1	0.00	2.1	0.00	-45.3	2.0	0.00	19.1	0.08	-46.0	1.9	0.00	19.6	0.09	-46.4
3.1	0.00	18.0	0.06	-44.2	3.0	0.00	3.0	0.00	-44.8	3.0	0.00	20.0	0.10	-45.1	3.0	0.00	20.6	0.11	-45.7
4.1	0.00	19.0	0.08	-43.6	4.0	0.00	4.0	0.00	-44.4	4.0	0.00	21.0	0.13	-44.3	4.0	0.00	21.5	0.14	-44.5
5.1	0.00	20.1	0.10	-42.8	5.1	0.00	5.1	0.00	-43.5	5.0	0.00	22.0	0.16	-43.3	5.0	0.00	22.5	0.18	-43.5
6.1	0.00	21.2	0.13	-42.5	6.1	0.00	6.1	0.00	-43.0	6.0	0.00	23.0	0.20	-42.5	6.0	0.00	23.4	0.22	-42.3
7.1	0.01	22.3	0.17	-41.6	7.1	0.01	7.1	0.01	-42.6	7.0	0.01	23.9	0.25	-41.8	7.0	0.00	24.4	0.28	-41.5
8.1	0.01	23.4	0.22	-41.2	8.1	0.01	8.1	0.01	-42.4	8.0	0.01	24.9	0.31	-41.3	8.0	0.01	25.4	0.34	-40.8
9.1	0.01	24.5	0.28	-40.8	9.1	0.01	9.1	0.01	-42.3	9.0	0.01	25.9	0.39	-41.1	9.0	0.01	26.3	0.43	-40.3
10.1	0.01	25.6	0.36	-40.6	10.1	0.01	10.1	0.01	-42.0	10.0	0.01	26.9	0.49	-41.1	10.0	0.01	27.3	0.54	-40.3
11.1	0.01	26.7	0.47	-40.3	11.1	0.01	11.1	0.01	-41.9	11.0	0.01	27.9	0.62	-41.3	11.0	0.01	28.3	0.67	-40.2
12.1	0.02	27.9	0.61	-40.4	12.1	0.02	12.1	0.02	-42.2	12.0	0.02	28.9	0.78	-41.6	12.0	0.02	29.3	0.84	-40.3
13.1	0.02	29.0	0.80	-40.5	13.0	0.02	13.0	0.02	-42.5	13.0	0.02	30.0	0.99	-42.1	13.0	0.02	30.3	1.06	-40.9
14.1	0.03	30.1	1.03	-40.6	14.0	0.03	14.0	0.03	-43.4	14.0	0.03	31.0	1.26	-43.2	14.0	0.03	31.2	1.33	-41.6
15.0	0.03	31.2	1.32	-41.6	15.0	0.03	15.0	0.03	-44.4	15.0	0.03	31.9	1.56	-44.2	15.0	0.03	32.2	1.65	-42.6
16.0	0.04	32.2	1.67	-43.2	16.0	0.04	16.0	0.04	-46.1	16.0	0.04	32.9	1.95	-44.7	16.0	0.04	33.1	2.05	-42.5
17.0	0.05	33.2	2.10	-43.8	17.0	0.05	17.0	0.05	-45.2	17.0	0.05	33.8	2.40	-42.3	16.9	0.05	34.0	2.51	-40.3
18.0	0.06	34.1	2.59	-41.5	18.0	0.06	18.0	0.06	-40.4	18.0	0.06	34.6	2.91	-38.1	17.9	0.06	34.8	3.02	-37.2
19.0	0.08	35.0	3.13	-37.1	19.0	0.08	19.0	0.08	-36.2	18.9	0.08	35.4	3.47	-34.6	18.9	0.08	35.5	3.58	-33.8
20.0	0.10	35.7	3.69	-33.7	20.0	0.10	20.0	0.10	-32.6	19.9	0.10	36.1	4.03	-31.6	19.9	0.10	36.2	4.15	-31.0
21.0	0.12	36.3	4.27	-30.8	21.0	0.12	21.0	0.12	-30.0	20.9	0.12	36.6	4.60	-29.1	20.9	0.12	36.7	4.72	-28.9
22.0	0.16	36.8	4.84	-28.3	21.9	0.16	21.9	0.16	-28.1	21.9	0.16	37.1	5.17	-27.2	21.9	0.16	37.2	5.28	-27.1
23.0	0.20	37.3	5.39	-26.8	23.0	0.20	23.0	0.20	-26.4	22.9	0.20	37.6	5.71	-25.9	22.9	0.20	37.6	5.81	-25.5
24.0	0.25	37.7	5.92	-25.2	24.0	0.25	24.0	0.25	-25.1	23.9	0.25	37.9	6.21	-24.7	23.9	0.25	38.0	6.32	-24.4
25.0	0.31	38.1	6.41	-24.1	25.0	0.31	25.0	0.31	-24.1	25.0	0.31	38.3	6.70	-23.5	25.0	0.31	38.3	6.79	-23.6

Note: Unless otherwise specified, input signal is setting modulation with the following condition.

Modulation; π/4DPQSK, 18kbps, α=0.35, Channel-Band-Width=18KHz, Channel-Spacing=25KHz

5-6. DC Power Supply vs.

OUTPUT POWER and DRAIN EFFICIENCY (Idq=0.075A, Pin=23dBm)

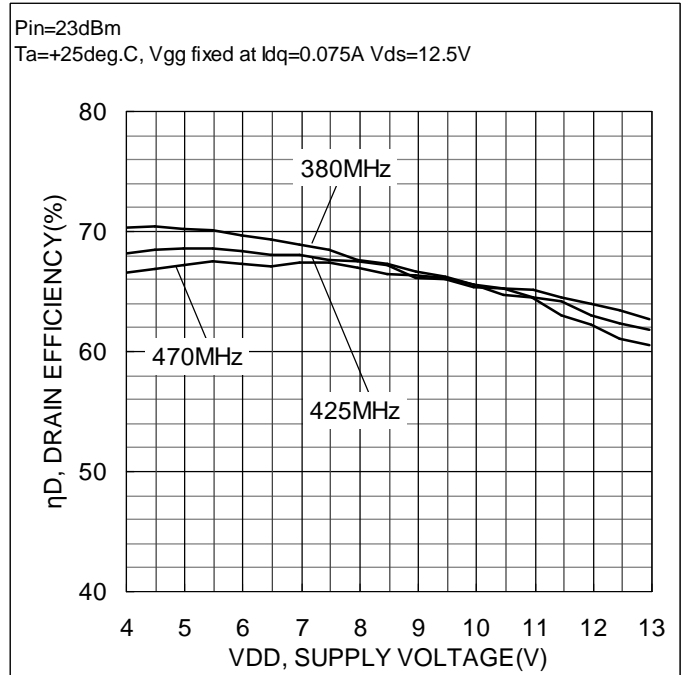
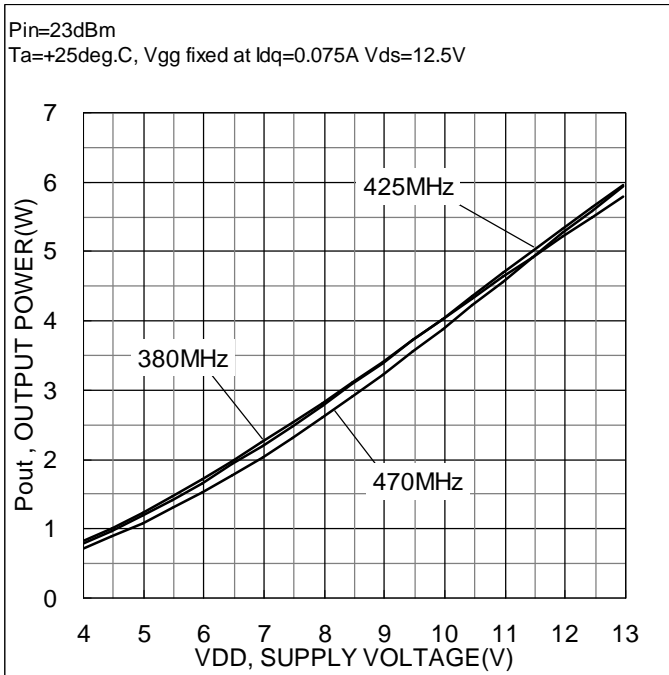

DRAIN CURRENT (Idq=0.075A, Pin=23dBm)

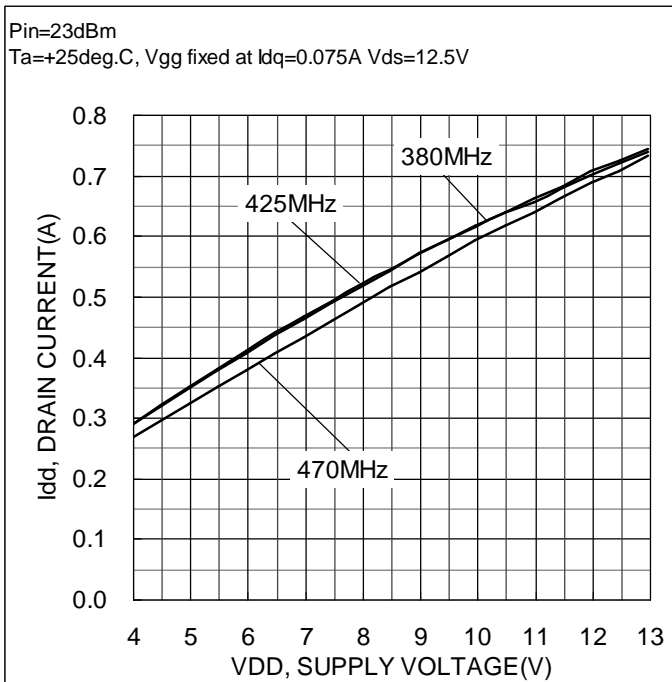

Note: Unless otherwise specified, input signal is setting modulation with the following condition.

Modulation; $\pi/4$ DPQSK, 18kbps, $\alpha=0.35$, Channel-Band-Width=18KHz, Channel-Spacing=25KHz

RD04HMS2 single-stage amplifier with f=380-470MHz evaluation board

- AN-UHF-114-A-

Ta=+25deg. C., I_{dq}=0.075A, Pin=23dBm

380MHz	V _{gg}	V _{dd}	I _{dq}	Pin		P _{out}		I _{dd}	η _D	η _{add}	Gain	I.R.L.
	(V)	(V)	(mA)	(dBm)	(W)	(dBm)	(W)	(A)	(%)	(%)	(dB)	(dB)
	2.63	4.0	57.1	23.0	0.20	29.1	0.81	0.29	70.3	53.1	6.1	-6.7
	2.63	4.5	58.0	23.0	0.20	30.1	1.01	0.32	70.5	56.6	7.1	-6.7
	2.63	5.0	58.8	23.0	0.20	30.9	1.23	0.35	70.2	58.9	7.9	-6.7
	2.63	5.5	59.8	23.0	0.20	31.7	1.47	0.38	70.1	60.5	8.6	-6.8
	2.63	6.0	60.9	23.0	0.20	32.3	1.71	0.41	69.6	61.5	9.3	-6.8
	2.63	6.5	62.0	23.0	0.20	33.0	1.98	0.44	69.3	62.3	9.9	-6.8
	2.63	7.0	63.1	23.0	0.20	33.5	2.24	0.47	68.9	62.8	10.5	-6.8
	2.63	7.5	64.2	23.0	0.20	34.0	2.52	0.49	68.5	63.1	11.0	-6.8
	2.63	8.0	65.3	23.0	0.20	34.5	2.81	0.52	67.7	62.9	11.5	-6.8
	2.63	8.5	66.4	23.0	0.20	34.9	3.10	0.55	67.3	63.0	11.9	-6.8
	2.63	9.0	67.6	23.0	0.20	35.3	3.41	0.57	66.6	62.8	12.3	-6.8
	2.63	9.5	69.0	23.0	0.20	35.7	3.72	0.59	66.2	62.7	12.7	-6.8
	2.63	10.0	70.3	23.0	0.20	36.0	4.02	0.62	65.6	62.4	13.0	-6.8
	2.63	10.5	71.8	23.0	0.20	36.4	4.33	0.64	64.7	61.8	13.4	-6.8
	2.63	11.0	73.2	23.0	0.20	36.7	4.63	0.66	64.5	61.7	13.7	-6.8
	2.63	11.5	74.5	23.0	0.20	36.9	4.91	0.68	63.0	60.4	13.9	-6.8
	2.63	12.0	76.2	23.0	0.20	37.2	5.21	0.70	62.2	59.8	14.2	-6.8
	2.63	12.4	77.9	23.0	0.20	37.4	5.48	0.72	61.1	58.8	14.4	-6.8
	2.63	13.0	79.6	23.0	0.20	37.6	5.79	0.74	60.5	58.4	14.6	-6.8

425MHz	V _{gg}	V _{dd}	I _{dq}	Pin		P _{out}		I _{dd}	η _D	η _{add}	Gain	I.R.L.
	(V)	(V)	(mA)	(dBm)	(W)	(dBm)	(W)	(A)	(%)	(%)	(dB)	(dB)
	2.63	4.0	56.9	23.0	0.20	28.9	0.78	0.29	68.2	50.7	5.5	-7.2
	2.63	4.5	57.9	23.0	0.20	29.9	0.98	0.32	68.5	54.4	6.5	-7.2
	2.63	5.0	58.8	23.0	0.20	30.8	1.19	0.35	68.6	57.0	7.4	-7.3
	2.63	5.5	59.8	23.0	0.20	31.5	1.42	0.38	68.6	58.9	8.2	-7.3
	2.63	6.0	60.6	23.0	0.20	32.2	1.66	0.41	68.4	60.1	8.8	-7.3
	2.63	6.5	61.8	23.0	0.20	32.9	1.93	0.44	68.1	61.0	9.5	-7.3
	2.63	7.0	62.9	23.0	0.20	33.4	2.19	0.46	68.1	61.9	10.1	-7.3
	2.63	7.5	64.1	23.0	0.20	34.0	2.48	0.49	67.6	62.2	10.7	-7.3
	2.63	8.0	65.1	23.0	0.20	34.4	2.78	0.52	67.5	62.6	11.2	-7.3
	2.63	8.5	66.3	23.0	0.20	34.9	3.08	0.54	67.2	62.9	11.7	-7.2
	2.63	9.0	67.7	23.0	0.20	35.3	3.39	0.57	66.1	62.2	12.1	-7.2
	2.63	9.5	68.9	23.0	0.20	35.7	3.72	0.59	66.0	62.5	12.5	-7.2
	2.63	10.0	70.2	23.0	0.20	36.1	4.03	0.62	65.4	62.2	12.9	-7.2
	2.63	10.5	71.5	23.0	0.20	36.4	4.36	0.64	65.2	62.2	13.2	-7.2
	2.63	11.0	72.7	23.0	0.20	36.7	4.69	0.66	64.5	61.8	13.6	-7.2
	2.63	11.5	74.3	23.0	0.20	37.0	5.01	0.68	64.1	61.6	13.9	-7.2
	2.63	12.0	75.8	23.0	0.20	37.3	5.32	0.71	63.0	60.6	14.2	-7.2
	2.63	12.4	77.5	23.0	0.20	37.5	5.64	0.73	62.4	60.2	14.5	-7.1
	2.63	13.0	79.1	23.0	0.20	37.8	5.96	0.74	61.8	59.7	14.7	-7.1

470MHz	V _{gg}	V _{dd}	I _{dq}	Pin		P _{out}		I _{dd}	η _D	η _{add}	Gain	I.R.L.
	(V)	(V)	(mA)	(dBm)	(W)	(dBm)	(W)	(A)	(%)	(%)	(dB)	(dB)
	2.63	4.0	56.9	23.0	0.20	28.5	0.71	0.27	66.6	47.8	5.5	-8.6
	2.63	4.5	57.9	23.0	0.20	29.5	0.89	0.30	66.9	51.9	6.5	-8.6
	2.63	5.0	58.8	23.0	0.20	30.4	1.08	0.32	67.2	54.9	7.4	-8.7
	2.63	5.5	59.8	23.0	0.20	31.1	1.30	0.35	67.5	57.2	8.2	-8.7
	2.63	6.0	60.6	23.0	0.20	31.8	1.53	0.38	67.3	58.5	8.8	-8.7
	2.63	6.5	61.8	23.0	0.20	32.5	1.77	0.41	67.1	59.5	9.5	-8.7
	2.63	7.0	62.9	23.0	0.20	33.1	2.04	0.43	67.4	60.8	10.1	-8.7
	2.63	7.5	64.1	23.0	0.20	33.7	2.32	0.46	67.4	61.6	10.7	-8.6
	2.63	8.0	65.1	23.0	0.20	34.2	2.61	0.49	67.0	61.9	11.2	-8.6
	2.63	8.5	66.3	23.0	0.20	34.6	2.91	0.52	66.4	61.9	11.7	-8.6
	2.63	9.0	67.7	23.0	0.20	35.1	3.22	0.54	66.4	62.3	12.1	-8.6
	2.63	9.5	68.9	23.0	0.20	35.5	3.55	0.57	66.2	62.5	12.5	-8.6
	2.63	10.0	70.2	23.0	0.20	35.9	3.87	0.59	65.6	62.2	12.9	-8.5
	2.63	10.5	71.5	23.0	0.20	36.3	4.22	0.62	65.2	62.1	13.2	-8.5
	2.63	11.0	72.7	23.0	0.20	36.6	4.56	0.64	65.2	62.4	13.6	-8.5
	2.63	11.5	74.3	23.0	0.20	36.9	4.91	0.66	64.5	61.9	13.9	-8.5
	2.63	12.0	75.8	23.0	0.20	37.2	5.26	0.69	64.0	61.6	14.2	-8.4
	2.63	12.4	77.5	23.0	0.20	37.5	5.58	0.71	63.4	61.1	14.5	-8.4
	2.63	13.0	79.1	23.0	0.20	37.7	5.94	0.73	62.6	60.5	14.7	-8.4

Note: Unless otherwise specified, input signal is setting modulation with the following condition.

Modulation; π/4DPQSK, 18kbps, α=0.35, Channel-Band-Width=18KHz, Channel-Spacing=25KHz

5-7. DC Power Supply vs.

OUTPUT POWER and DRAIN EFFICIENCY (Idq=0.075A, Pin=11.5dBm)

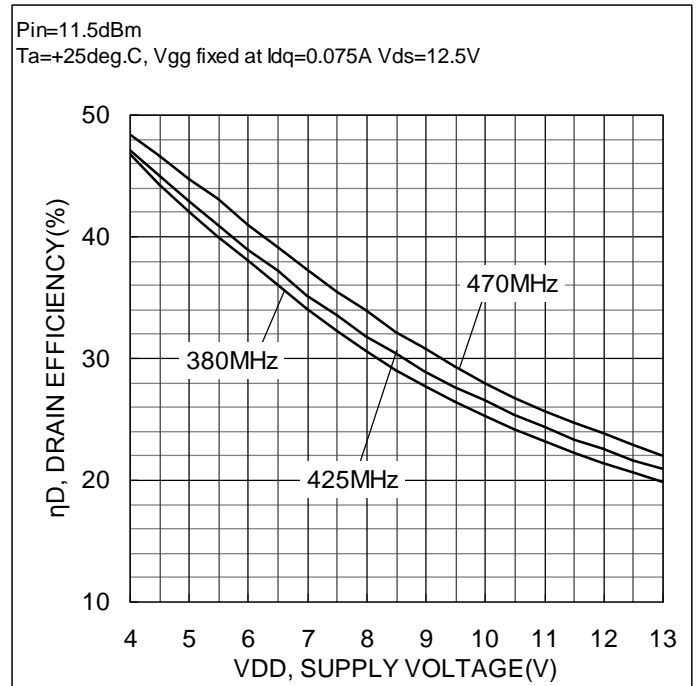
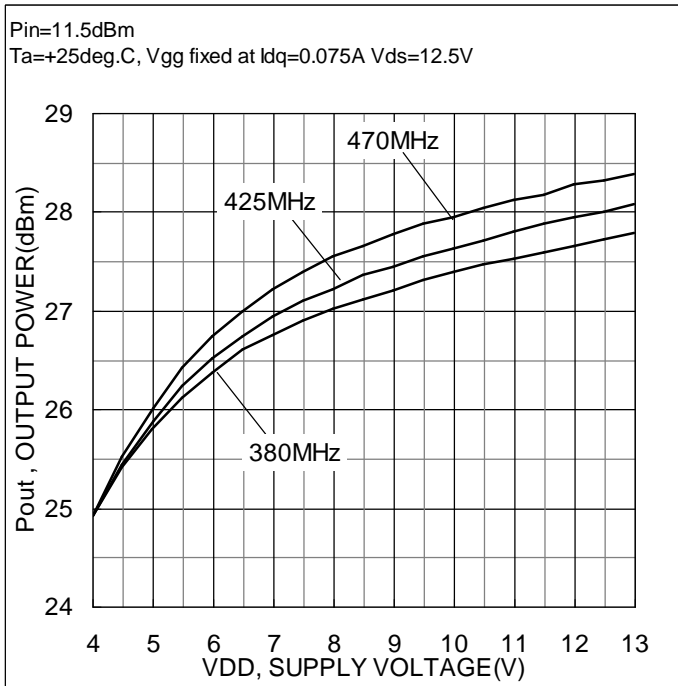

+ / - ADJACENT CHANNEL POWER (Idq=0.075A, Pin=11.5dBm)

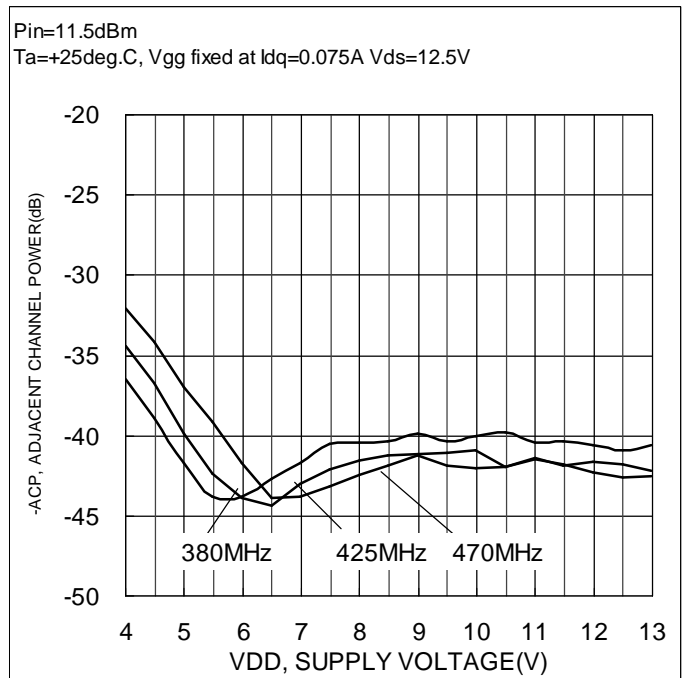
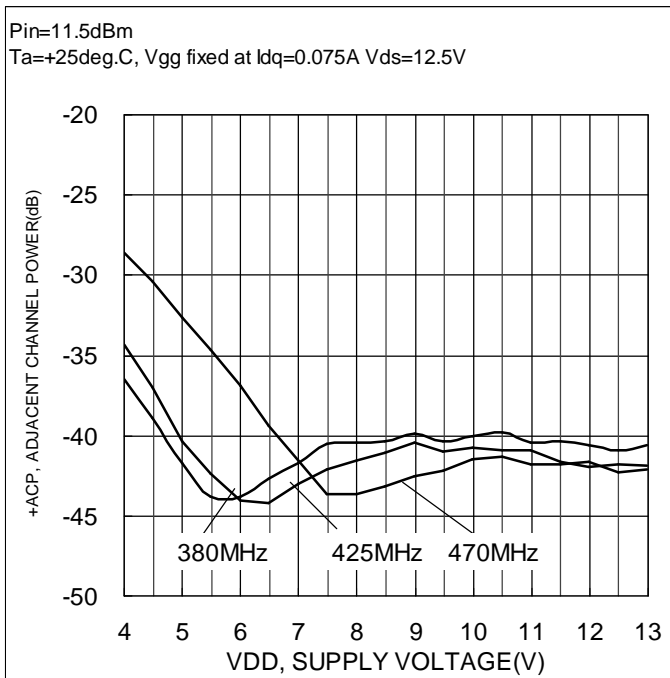

Note: Unless otherwise specified, input signal is setting modulation with the following condition.

Modulation; $\pi/4$ DPQSK, 18kbps, $\alpha=0.35$, Channel-Band-Width=18KHz, Channel-Spacing=25KHz

RD04HMS2 single-stage amplifier with f=380-470MHz evaluation board

- AN-UHF-114-A-

Ta=+25deg. C., I_{dq}=0.075A, Pin=11.5dBm

380MHz	V _{gg}	V _{dd}	I _{dq}	Pin		Pout		I _{dd}	η _D	η _{add}	Gain	I.R.L.	-ACP	+ACP
	(V)	(V)	(mA)	(dBm)	(W)	(dBm)	(W)	(A)	(%)	(%)	(dB)	(dB)	(dB)	(dB)
	2.63	4.0	56.9	11.5	0.014	24.9	0.31	0.17	46.8	44.7	13.4	-7.7	-36.5	-36.1
	2.63	4.5	57.8	11.5	0.014	25.4	0.35	0.18	44.3	42.5	13.9	-7.4	-38.9	-39.0
	2.63	5.0	58.6	11.5	0.014	25.8	0.38	0.18	42.1	40.5	14.3	-7.2	-41.7	-41.4
	2.63	5.5	59.4	11.5	0.014	26.1	0.41	0.19	40.0	38.6	14.6	-7.1	-43.8	-43.6
	2.63	6.0	60.5	11.5	0.014	26.4	0.43	0.19	38.0	36.8	14.9	-6.9	-43.8	-43.9
	2.63	6.5	61.6	11.5	0.014	26.6	0.46	0.20	36.1	34.9	15.1	-6.8	-42.7	-43.0
	2.63	7.0	62.7	11.5	0.014	26.8	0.47	0.20	34.0	33.0	15.2	-6.7	-41.7	-41.9
	2.63	7.5	63.8	11.5	0.014	26.9	0.49	0.20	32.3	31.3	15.4	-6.6	-40.5	-41.0
	2.63	8.0	64.9	11.5	0.014	27.0	0.50	0.21	30.6	29.8	15.5	-6.6	-40.4	-40.0
	2.63	8.5	66.0	11.5	0.014	27.1	0.52	0.21	29.1	28.3	15.6	-6.5	-40.4	-40.2
	2.63	9.0	67.1	11.5	0.014	27.2	0.53	0.21	27.7	27.0	15.7	-6.5	-39.9	-40.1
	2.63	9.5	68.5	11.5	0.014	27.3	0.54	0.21	26.5	25.8	15.8	-6.4	-40.4	-40.0
	2.63	10.0	69.6	11.5	0.014	27.4	0.55	0.22	25.3	24.6	15.9	-6.4	-40.0	-40.3
	2.63	10.5	71.0	11.5	0.014	27.5	0.56	0.22	24.2	23.6	16.0	-6.4	-39.8	-40.3
	2.63	11.0	72.3	11.5	0.014	27.5	0.57	0.22	23.2	22.6	16.0	-6.4	-40.4	-40.4
	2.63	11.5	73.6	11.5	0.014	27.6	0.58	0.23	22.2	21.7	16.1	-6.3	-40.3	-40.7
	2.63	12.0	75.1	11.5	0.014	27.7	0.58	0.23	21.4	20.9	16.1	-6.3	-40.6	-40.8
	2.63	12.5	76.5	11.5	0.014	27.7	0.59	0.23	20.7	20.2	16.2	-6.3	-40.9	-41.1
	2.63	13.0	78.1	11.5	0.014	27.8	0.60	0.23	19.9	19.4	16.3	-6.3	-40.6	-41.0

425MHz	V _{gg}	V _{dd}	I _{dq}	Pin		Pout		I _{dd}	η _D	η _{add}	Gain	I.R.L.	-ACP	+ACP
	(V)	(V)	(mA)	(dBm)	(W)	(dBm)	(W)	(A)	(%)	(%)	(dB)	(dB)	(dB)	(dB)
	2.63	4.0	57.0	11.5	0.014	24.9	0.31	0.17	47.1	45.0	13.5	-7.9	-34.3	-34.4
	2.63	4.5	57.9	11.5	0.014	25.5	0.35	0.17	45.0	43.2	14.1	-7.7	-37.0	-36.7
	2.63	5.0	58.7	11.5	0.014	25.9	0.39	0.18	42.9	41.3	14.5	-7.5	-40.4	-39.9
	2.63	5.5	59.6	11.5	0.014	26.2	0.42	0.19	41.0	39.6	14.9	-7.4	-42.3	-42.4
	2.63	6.0	60.7	11.5	0.014	26.5	0.45	0.19	39.0	37.7	15.3	-7.2	-44.1	-43.9
	2.63	6.5	61.6	11.5	0.014	26.8	0.47	0.20	37.2	36.0	15.5	-7.1	-44.2	-44.4
	2.63	7.0	62.9	11.5	0.014	26.9	0.49	0.20	35.2	34.2	15.7	-7.1	-43.0	-43.0
	2.63	7.5	63.9	11.5	0.014	27.1	0.51	0.20	33.5	32.6	15.9	-7.0	-42.1	-42.1
	2.63	8.0	65.1	11.5	0.014	27.2	0.53	0.21	31.8	30.9	16.1	-6.9	-41.6	-41.5
	2.63	8.5	66.2	11.5	0.014	27.4	0.55	0.21	30.5	29.7	16.2	-6.9	-41.1	-41.2
	2.63	9.0	67.5	11.5	0.014	27.5	0.56	0.21	28.9	28.2	16.3	-6.8	-40.4	-41.1
	2.63	9.5	68.6	11.5	0.014	27.6	0.57	0.22	27.7	27.0	16.4	-6.8	-41.0	-41.1
	2.63	10.0	70.0	11.5	0.014	27.6	0.58	0.22	26.5	25.9	16.5	-6.8	-40.8	-40.9
	2.63	10.5	71.2	11.5	0.014	27.7	0.59	0.22	25.3	24.7	16.6	-6.8	-40.9	-42.0
	2.63	11.0	72.4	11.5	0.014	27.8	0.60	0.23	24.4	23.8	16.6	-6.7	-40.9	-41.4
	2.63	11.5	73.6	11.5	0.014	27.9	0.61	0.23	23.4	22.8	16.7	-6.7	-41.7	-41.9
	2.63	12.0	75.3	11.5	0.014	28.0	0.62	0.23	22.6	22.0	16.8	-6.7	-41.9	-41.6
	2.63	12.5	76.7	11.5	0.014	28.0	0.63	0.23	21.6	21.2	16.8	-6.7	-41.8	-41.8
	2.63	13.0	78.3	11.5	0.014	28.1	0.64	0.24	21.0	20.5	16.9	-6.7	-41.9	-42.2

470MHz	V _{gg}	V _{dd}	I _{dq}	Pin		Pout		I _{dd}	η _D	η _{add}	Gain	I.R.L.	-ACP	+ACP
	(V)	(V)	(mA)	(dBm)	(W)	(dBm)	(W)	(A)	(%)	(%)	(dB)	(dB)	(dB)	(dB)
	2.63	4.0	57.0	11.5	0.014	24.9	0.31	0.16	48.3	46.2	13.5	-9.6	-28.6	-32.0
	2.63	4.5	57.9	11.5	0.014	25.5	0.36	0.17	46.6	44.8	14.1	-9.3	-30.4	-34.1
	2.63	5.0	58.7	11.5	0.014	26.0	0.40	0.18	44.7	43.1	14.5	-9.0	-32.6	-37.0
	2.63	5.5	59.6	11.5	0.014	26.4	0.44	0.19	43.2	41.8	14.9	-8.8	-34.6	-39.1
	2.63	6.0	60.7	11.5	0.014	26.7	0.47	0.19	40.9	39.7	15.3	-8.6	-36.9	-41.7
	2.63	6.5	61.6	11.5	0.014	27.0	0.50	0.20	39.2	38.1	15.5	-8.4	-39.4	-43.9
	2.63	7.0	62.9	11.5	0.014	27.2	0.53	0.20	37.3	36.3	15.7	-8.3	-41.6	-43.8
	2.63	7.5	63.9	11.5	0.014	27.4	0.55	0.21	35.5	34.6	15.9	-8.2	-43.7	-43.1
	2.63	8.0	65.1	11.5	0.014	27.6	0.57	0.21	34.0	33.1	16.1	-8.1	-43.7	-42.5
	2.63	8.5	66.2	11.5	0.014	27.7	0.58	0.21	32.2	31.4	16.2	-8.0	-43.2	-41.8
	2.63	9.0	67.5	11.5	0.014	27.8	0.60	0.22	30.8	30.1	16.3	-7.9	-42.5	-41.3
	2.63	9.5	68.6	11.5	0.014	27.9	0.61	0.22	29.3	28.6	16.4	-7.9	-42.2	-41.9
	2.63	10.0	70.0	11.5	0.014	28.0	0.62	0.22	28.0	27.3	16.5	-7.8	-41.5	-42.0
	2.63	10.5	71.2	11.5	0.014	28.0	0.64	0.23	26.8	26.2	16.6	-7.8	-41.3	-42.0
	2.63	11.0	72.4	11.5	0.014	28.1	0.65	0.23	25.7	25.2	16.6	-7.8	-41.8	-41.5
	2.63	11.5	73.6	11.5	0.014	28.2	0.66	0.23	24.7	24.2	16.7	-7.7	-41.8	-41.8
	2.63	12.0	75.3	11.5	0.014	28.3	0.67	0.24	23.8	23.3	16.8	-7.7	-41.6	-42.2
	2.63	12.5	76.7	11.5	0.014	28.3	0.68	0.24	22.9	22.4	16.8	-7.7	-42.2	-42.6
	2.63	13.0	78.3	11.5	0.014	28.4	0.69	0.24	22.1	21.6	16.9	-7.7	-42.2	-42.5

Note: Unless otherwise specified, input signal is setting modulation with the following condition.

Modulation; π/4DPQSK, 18kbps, α=0.35, Channel-Band-Width=18KHz, Channel-Spacing=25KHz

5-8. Frequency vs.

OUTPUT POWER, POWER GAIN, DRAIN EFFICIENCY, DRAIN CURRENT and INPUT RETURN LOSS

(Vds=9.1V, Pin=23dBm)

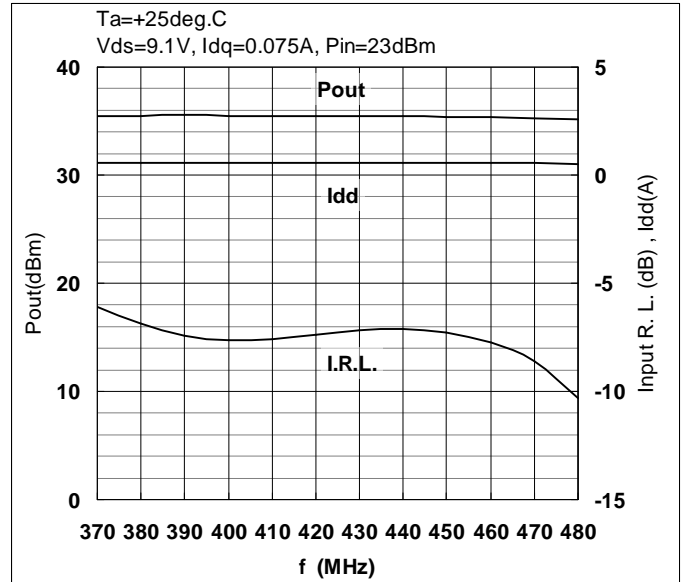
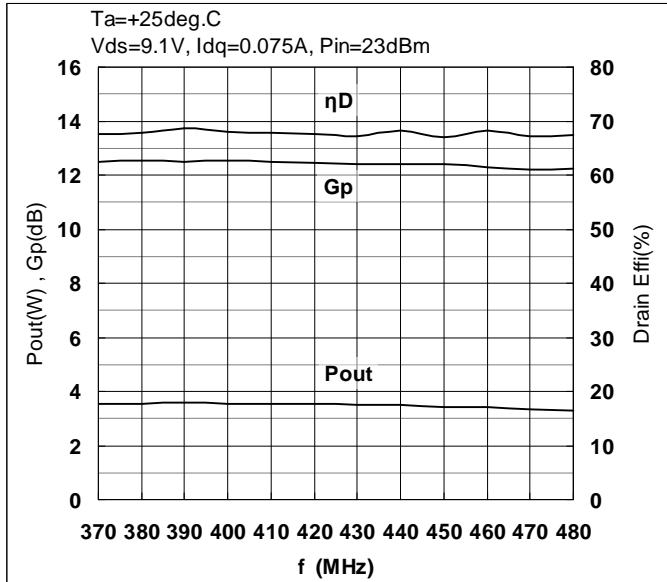

Ta=+25deg. C., Vds=9.1V, Idq=0.075A, Pin=23dBm

Freq. (MHz)	Vgg (V)	Pin (dBm)	Pin (W)	Pout (dBm)	Pout (W)	Gp (dB)	ID(RF) (A)	ηadd (%)	ηD (%)	I.R.L. (dB)
370	2.65	23.0	0.2	35.5	3.5	12.5	0.58	63.9	67.7	-6.1
380	2.65	23.0	0.2	35.5	3.5	12.5	0.58	64.1	67.9	-6.9
390	2.65	23.1	0.2	35.6	3.6	12.5	0.58	64.8	68.6	-7.4
400	2.65	23.0	0.2	35.5	3.6	12.5	0.58	64.2	68.0	-7.6
410	2.65	23.0	0.2	35.5	3.5	12.5	0.58	64.1	67.9	-7.6
420	2.65	23.0	0.2	35.5	3.5	12.5	0.58	63.9	67.7	-7.4
430	2.65	23.0	0.2	35.5	3.5	12.4	0.58	63.4	67.2	-7.2
440	2.65	23.0	0.2	35.4	3.5	12.4	0.56	64.3	68.2	-7.1
450	2.65	23.0	0.2	35.4	3.4	12.4	0.56	63.2	67.1	-7.2
460	2.65	23.0	0.2	35.3	3.4	12.3	0.55	64.2	68.2	-7.7
470	2.65	23.0	0.2	35.3	3.4	12.2	0.55	63.1	67.1	-8.6
480	2.65	22.9	0.2	35.2	3.3	12.2	0.54	63.3	67.4	-10.3

Note: Unless otherwise specified, input signal is setting modulation with the following condition.

Modulation; π/4DPQSK, 18kbps, α=0.35, Channel-Band-Width=18KHz, Channel-Spacing=25KHz

5-9. RF Power vs.

INPUT POWER (Vds=9.1V)

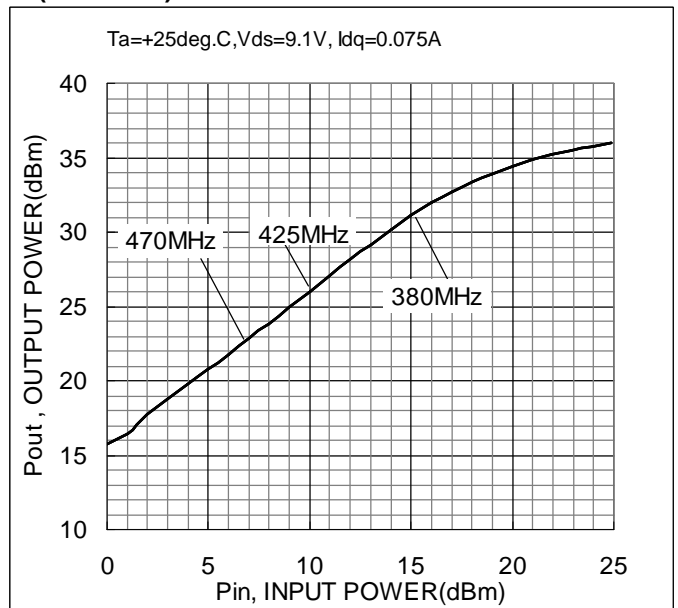
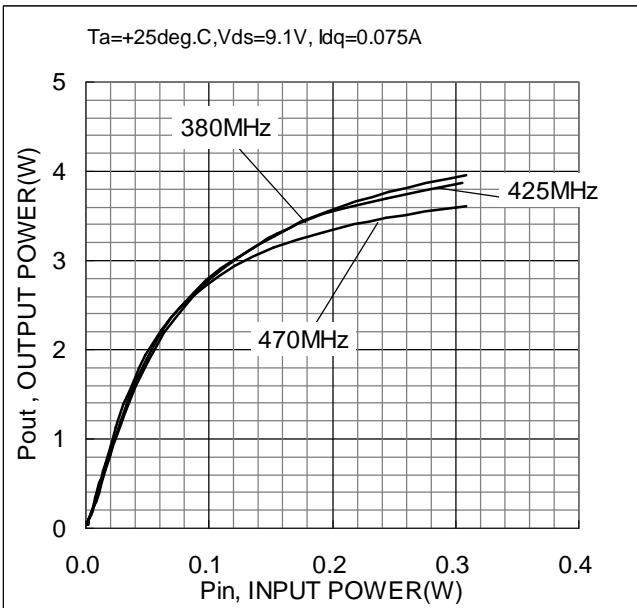

POWER GAIN and +/- ADJACENT CHANNEL POWER (Vds=9.1V)

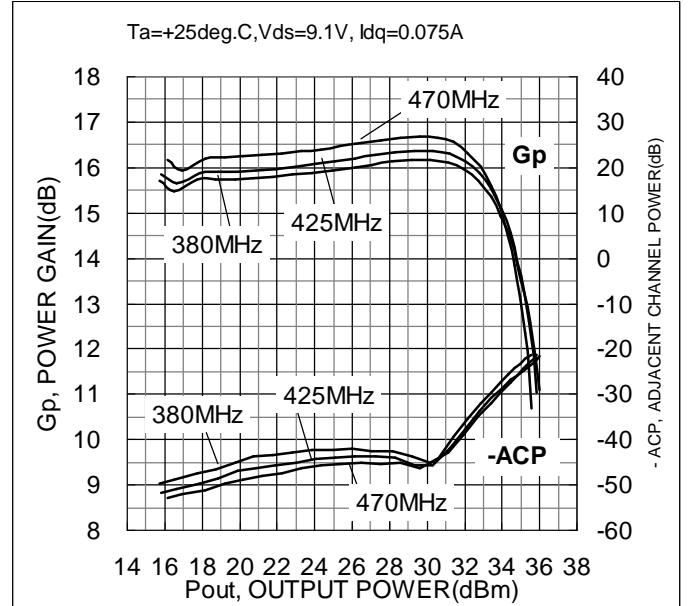
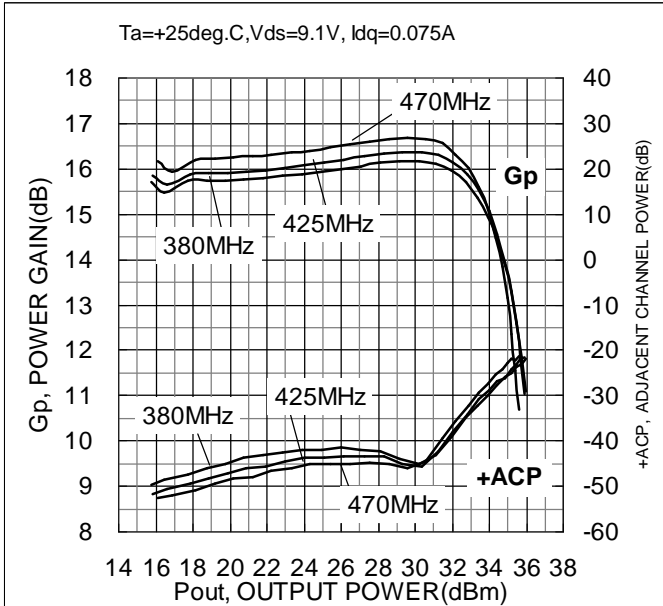

Note: Unless otherwise specified, input signal is setting modulation with the following condition.

Modulation; $\pi/4$ DPQSK, 18kbps, $\alpha=0.35$, Channel-Band-Width=18KHz, Channel-Spacing=25KHz

DRAIN EFFICIENCY (Vds=9.1V)

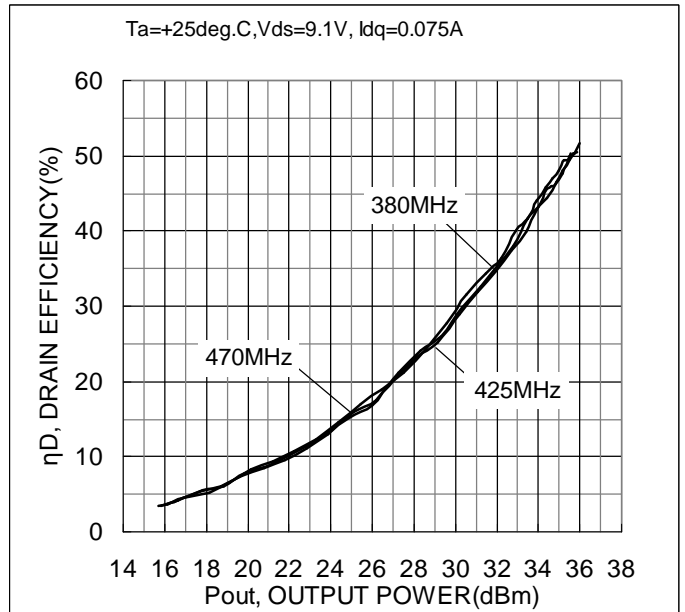
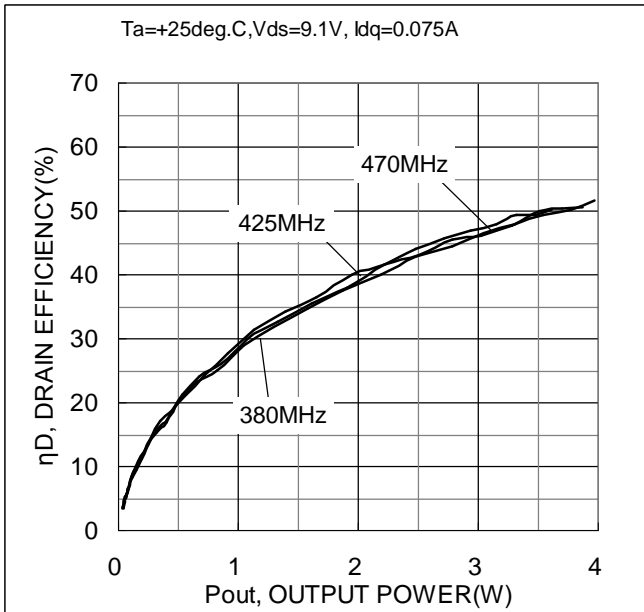

DRAIN CURRENT (Vds=9.1V)

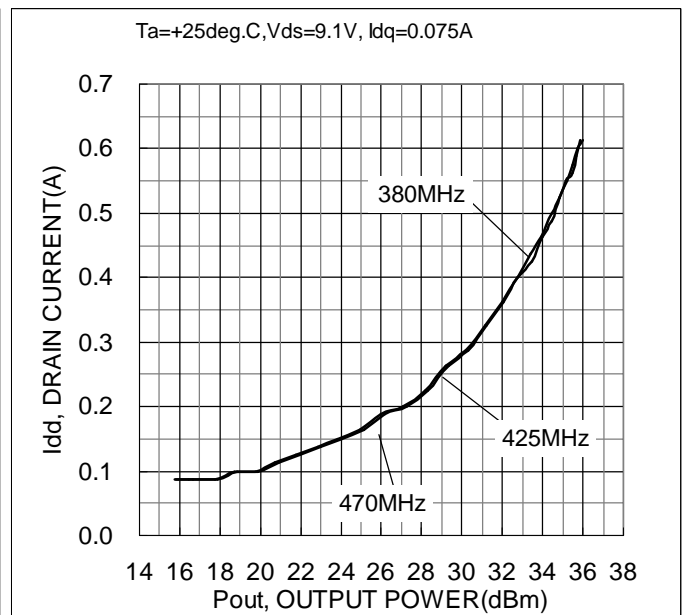
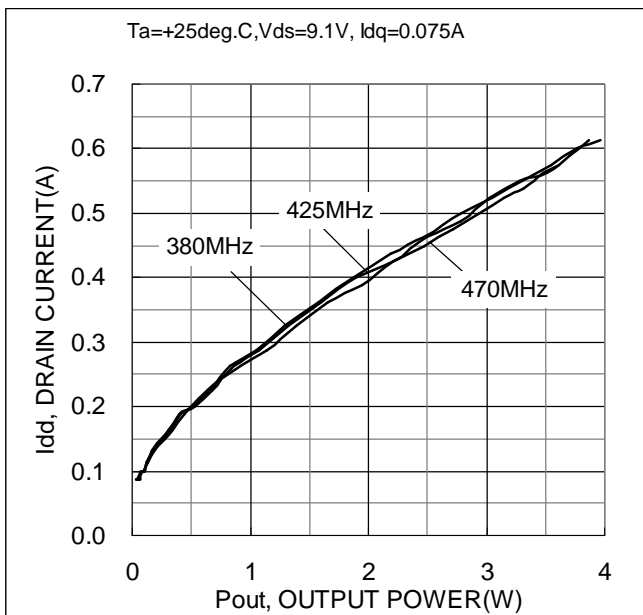

Note: Unless otherwise specified, input signal is setting modulation with the following condition.

Modulation; $\pi/4$ DPSK, 18kbps, $\alpha=0.35$, Channel-Band-Width=18KHz, Channel-Spacing=25KHz

INPUT RETURN LOSS (Vds=9.1V)

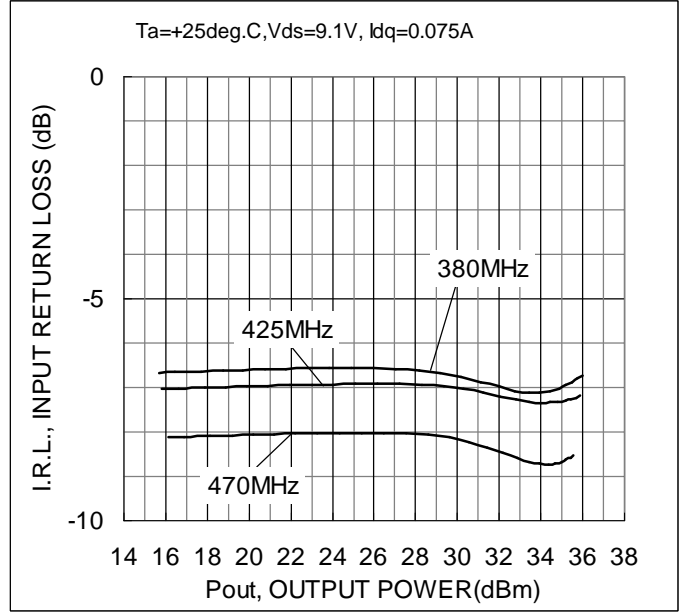
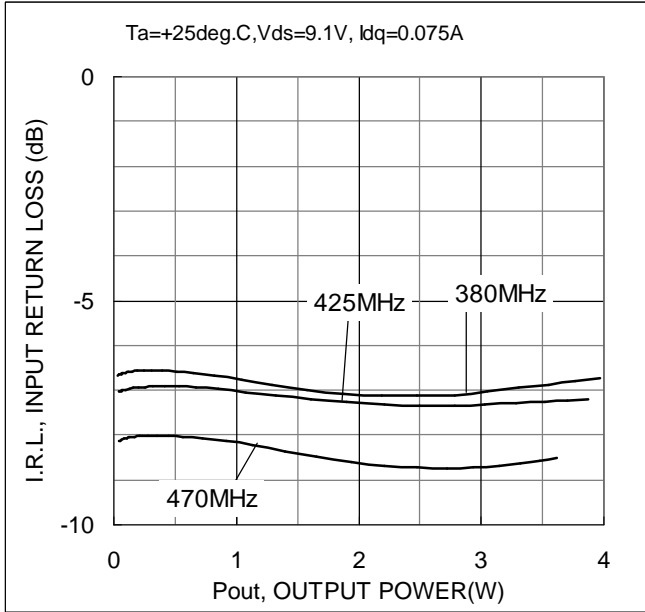

Ta=+25deg. C., Vds=9.1V

380MHz	V _{gg} (V)	P _{in} (dBm)	P _{out} (dBm) (W)		G _p (dB)	ID(RF) (A)	η _{add} (%)	η _D (%)	I.R.L. (dB)	+ACP (dB)	-ACP (dB)
	2.65	0.0	15.7	0.0	15.7	0.09	3.3	3.4	-6.7	-49.7	-49.8
	2.65	1.0	16.5	0.0	15.5	0.09	3.9	4.0	-6.7	-48.5	-48.8
	2.65	2.0	17.7	0.1	15.7	0.09	5.2	5.4	-6.6	-47.4	-47.4
	2.65	3.0	18.7	0.1	15.7	0.10	5.8	6.0	-6.6	-46.1	-46.4
	2.65	4.0	19.7	0.1	15.7	0.10	7.3	7.5	-6.6	-45.1	-45.0
	2.65	5.0	20.8	0.1	15.8	0.11	8.2	8.4	-6.6	-43.6	-43.7
	2.65	6.0	21.8	0.2	15.8	0.13	9.4	9.6	-6.6	-43.1	-43.3
	2.65	7.0	22.8	0.2	15.8	0.14	10.9	11.1	-6.6	-42.5	-43.0
	2.65	8.0	23.9	0.2	15.9	0.15	12.6	13.0	-6.6	-41.9	-42.1
	2.65	9.0	24.9	0.3	15.9	0.16	14.9	15.3	-6.6	-41.9	-42.1
	2.65	10.0	26.0	0.4	16.0	0.19	16.5	16.9	-6.6	-41.5	-41.9
	2.65	11.0	27.1	0.5	16.1	0.20	19.8	20.3	-6.6	-41.9	-42.6
	2.65	12.0	28.1	0.7	16.1	0.23	22.6	23.2	-6.6	-42.2	-42.6
	2.65	13.0	29.2	0.8	16.2	0.26	24.5	25.1	-6.7	-43.9	-43.6
	2.65	14.0	30.2	1.0	16.2	0.29	28.3	29.0	-6.8	-45.0	-45.1
	2.65	15.0	31.1	1.3	16.1	0.33	31.1	31.9	-6.9	-43.2	-42.8
	2.65	16.0	32.0	1.6	16.0	0.36	33.9	34.8	-7.0	-39.1	-38.7
	2.65	17.0	32.7	1.9	15.7	0.40	36.5	37.5	-7.1	-34.9	-34.9
	2.65	18.0	33.4	2.2	15.4	0.44	38.8	40.0	-7.1	-32.1	-32.0
	2.65	19.0	33.9	2.5	14.9	0.46	41.4	42.8	-7.1	-29.9	-29.6
	2.65	20.0	34.4	2.8	14.4	0.50	42.9	44.5	-7.1	-27.6	-27.4
	2.65	21.0	34.8	3.0	13.9	0.53	44.5	46.4	-7.0	-25.8	-25.9
	2.65	21.9	35.2	3.3	13.3	0.55	45.8	48.1	-6.9	-25.0	-24.7
	2.65	22.9	35.5	3.5	12.6	0.58	46.6	49.4	-6.9	-23.6	-23.6
	2.65	23.9	35.8	3.8	11.8	0.60	46.9	50.2	-6.8	-23.0	-22.7
	2.65	24.9	36.0	4.0	11.1	0.61	47.7	51.7	-6.7	-21.8	-21.5

Note: Unless otherwise specified, input signal is setting modulation with the following condition.

Modulation; π/4DPQSK, 18kbps, α=0.35, Channel-Band-Width=18KHz, Channel-Spacing=25KHz

RD04HMS2 single-stage amplifier with f=380-470MHz evaluation board

- AN-UHF-114-A-

425MHz	V _{gg}	Pin		P _{out}		G _p	ID(RF)	η _{add}	η _D	I.R.L.	+ACP	-ACP
	(V)	(dBm)	(W)	(dBm)	(W)	(dB)	(A)	(%)	(%)	(dB)	(dB)	(dB)
2.65	0.0	0.00	15.8	0.0	15.9	0.09	3.4	3.5	-7.0	-51.7	-51.6	
2.65	1.0	0.00	16.6	0.0	15.6	0.09	4.1	4.2	-7.0	-50.4	-50.9	
2.65	2.0	0.00	17.9	0.1	15.9	0.09	5.4	5.6	-7.0	-49.3	-49.7	
2.65	3.0	0.00	18.9	0.1	15.9	0.10	6.0	6.2	-7.0	-48.2	-48.5	
2.65	3.9	0.00	19.9	0.1	15.9	0.10	7.6	7.8	-7.0	-47.0	-46.9	
2.65	5.0	0.00	20.9	0.1	15.9	0.11	8.5	8.7	-7.0	-46.0	-46.3	
2.65	6.0	0.00	21.9	0.2	16.0	0.13	9.7	10.0	-7.0	-45.7	-45.5	
2.65	7.0	0.00	23.0	0.2	16.0	0.14	11.3	11.6	-6.9	-44.6	-45.2	
2.65	8.0	0.01	24.0	0.3	16.1	0.15	13.2	13.5	-6.9	-43.6	-44.3	
2.65	9.0	0.01	25.1	0.3	16.1	0.16	15.5	15.9	-6.9	-43.6	-44.0	
2.65	10.0	0.01	26.2	0.4	16.2	0.19	17.2	17.6	-6.9	-43.3	-43.6	
2.65	11.0	0.01	27.3	0.5	16.3	0.20	20.7	21.2	-6.9	-43.3	-43.5	
2.65	12.0	0.02	28.3	0.7	16.3	0.23	23.5	24.0	-6.9	-43.5	-43.9	
2.65	13.0	0.02	29.3	0.9	16.4	0.26	25.5	26.1	-7.0	-45.0	-45.7	
2.65	14.0	0.02	30.3	1.1	16.4	0.29	29.2	29.9	-7.0	-45.6	-45.6	
2.65	14.9	0.03	31.2	1.3	16.3	0.33	31.9	32.7	-7.1	-42.1	-42.1	
2.65	15.9	0.04	32.1	1.6	16.1	0.36	34.6	35.4	-7.2	-38.0	-37.6	
2.65	16.9	0.05	32.8	1.9	15.9	0.40	37.0	38.0	-7.3	-34.2	-33.6	
2.65	17.9	0.06	33.5	2.2	15.5	0.43	40.5	41.7	-7.3	-30.8	-30.8	
2.65	18.9	0.08	34.0	2.5	15.1	0.46	41.8	43.1	-7.4	-28.7	-28.9	
2.65	19.9	0.10	34.4	2.8	14.6	0.49	44.0	45.6	-7.3	-26.6	-26.7	
2.65	20.9	0.12	34.8	3.0	13.9	0.53	44.3	46.1	-7.3	-26.2	-25.8	
2.65	21.8	0.15	35.2	3.3	13.3	0.55	45.5	47.7	-7.3	-24.1	-24.1	
2.65	22.8	0.19	35.5	3.5	12.6	0.56	47.2	50.0	-7.3	-22.9	-23.0	
2.65	23.9	0.24	35.7	3.7	11.8	0.59	47.0	50.3	-7.2	-22.0	-22.2	
2.65	24.9	0.31	35.9	3.9	11.0	0.61	46.6	50.5	-7.2	-21.7	-21.4	

470MHz	V _{gg}	Pin		P _{out}		G _p	ID(RF)	η _{add}	η _D	I.R.L.	+ACP	-ACP
	(V)	(dBm)	(W)	(dBm)	(W)	(dB)	(A)	(%)	(%)	(dB)	(dB)	(dB)
2.65	0.0	0.00	16.1	0.0	16.2	0.09	3.6	3.7	-8.1	-52.6	-52.9	
2.65	1.0	0.00	16.9	0.0	15.9	0.09	4.3	4.5	-8.1	-51.9	-51.9	
2.65	1.9	0.00	18.1	0.1	16.2	0.10	5.1	5.2	-8.1	-50.9	-51.0	
2.65	2.9	0.00	19.2	0.1	16.2	0.10	6.5	6.6	-8.1	-49.5	-49.7	
2.65	3.9	0.00	20.2	0.1	16.2	0.10	8.1	8.3	-8.1	-48.2	-48.7	
2.65	4.9	0.00	21.2	0.1	16.3	0.11	9.1	9.4	-8.1	-47.8	-47.9	
2.65	5.9	0.00	22.2	0.2	16.3	0.13	10.5	10.7	-8.0	-46.7	-47.3	
2.65	6.9	0.00	23.3	0.2	16.4	0.14	12.1	12.4	-8.0	-46.0	-46.2	
2.65	7.9	0.01	24.4	0.3	16.4	0.15	14.2	14.5	-8.0	-45.2	-45.7	
2.65	8.9	0.01	25.4	0.3	16.5	0.16	16.7	17.1	-8.0	-45.0	-45.4	
2.65	9.9	0.01	26.5	0.4	16.5	0.19	18.5	18.9	-8.0	-45.0	-45.1	
2.65	10.9	0.01	27.5	0.6	16.6	0.21	20.8	21.2	-8.0	-44.8	-45.3	
2.65	11.9	0.02	28.6	0.7	16.7	0.24	23.7	24.2	-8.1	-45.0	-45.0	
2.65	12.9	0.02	29.6	0.9	16.7	0.26	27.1	27.7	-8.1	-45.9	-46.2	
2.65	13.9	0.02	30.6	1.1	16.7	0.29	30.8	31.5	-8.2	-44.5	-44.4	
2.65	14.9	0.03	31.4	1.4	16.6	0.33	33.5	34.3	-8.4	-39.4	-39.4	
2.65	15.9	0.04	32.2	1.7	16.3	0.36	35.6	36.5	-8.5	-35.6	-35.3	
2.65	16.8	0.05	32.9	1.9	16.0	0.39	39.0	40.0	-8.6	-32.1	-32.0	
2.65	17.9	0.06	33.5	2.2	15.6	0.43	40.5	41.7	-8.7	-29.4	-29.6	
2.65	18.8	0.08	33.9	2.5	15.1	0.45	42.7	44.0	-8.7	-27.3	-27.3	
2.65	19.9	0.10	34.3	2.7	14.5	0.48	44.1	45.8	-8.7	-25.3	-25.6	
2.65	20.8	0.12	34.7	2.9	13.8	0.50	45.1	47.0	-8.7	-24.1	-24.3	
2.65	21.8	0.15	35.0	3.1	13.2	0.53	45.6	48.0	-8.7	-22.8	-23.2	
2.65	22.8	0.19	35.2	3.3	12.4	0.54	46.5	49.4	-8.6	-22.0	-22.1	
2.65	23.9	0.24	35.4	3.5	11.5	0.56	45.9	49.4	-8.6	-22.1	-21.7	
2.65	24.9	0.31	35.6	3.6	10.7	0.58	46.0	50.3	-8.5	-21.5	-21.3	

Note: Unless otherwise specified, input signal is setting modulation with the following condition.

Modulation; π/4DPQSK, 18kbps, α=0.35, Channel-Band-Width=18KHz, Channel-Spacing=25KHz

5-10. Drain Quiescent Current vs.

OUTPUT POWER and DRAIN EFFICIENCY (Vds=9.1V, Pin=23dBm)

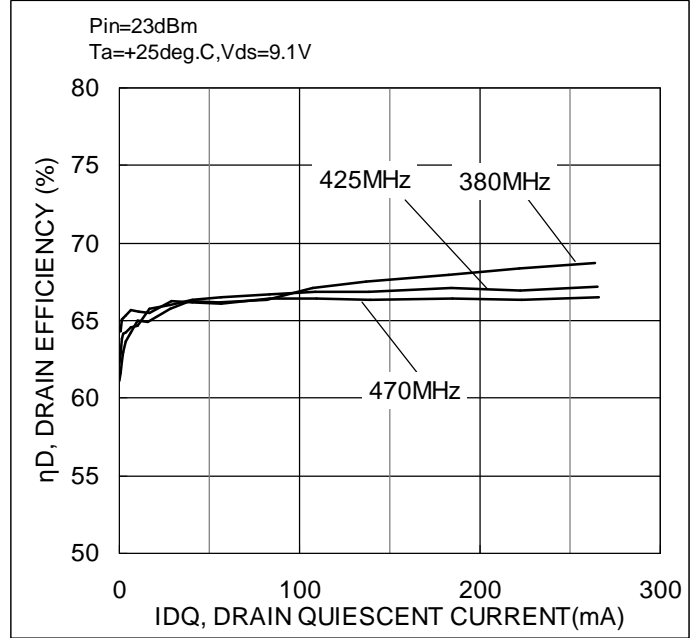
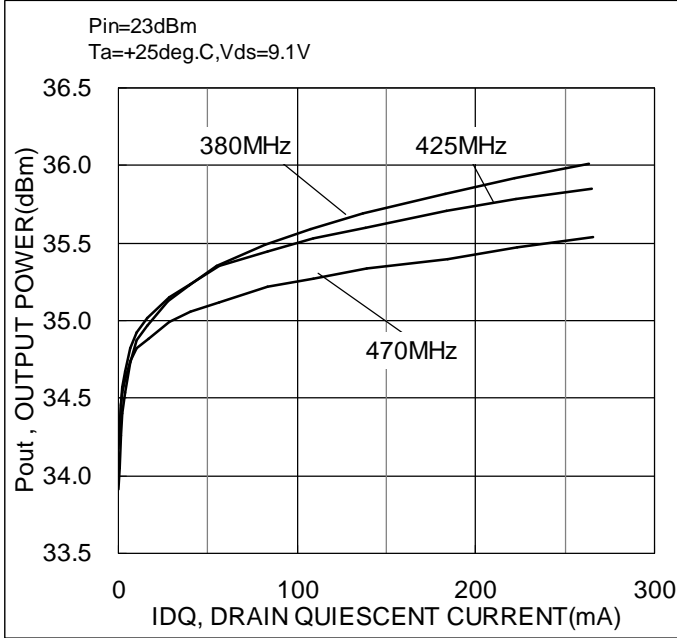

Ta=+25deg. C., Vds=9.1V, Pin=23dBm

380MHz	Vgg (V)	Idq (mA)	Pin		Pout		Idd (A)	η_D (%)	η_{add} (%)	Gain (dB)	I.R.L. (dB)
			(dBm)	(W)	(dBm)	(W)					
	2.10	0.3	23.0	0.20	33.9	2.5	0.44	61.1	56.2	10.9	-6.3
	2.15	0.6	23.0	0.20	34.1	2.5	0.45	61.7	56.8	11.1	-6.4
	2.21	1.2	23.0	0.20	34.3	2.7	0.47	62.4	57.8	11.3	-6.4
	2.25	2.0	23.0	0.20	34.4	2.8	0.48	63.0	58.5	11.4	-6.5
	2.30	3.3	23.0	0.20	34.5	2.8	0.49	63.6	59.2	11.5	-6.5
	2.36	6.3	23.0	0.20	34.7	3.0	0.51	64.2	59.9	11.7	-6.6
	2.40	10.2	23.0	0.20	34.9	3.1	0.52	65.0	60.7	11.8	-6.6
	2.45	16.0	23.0	0.20	35.0	3.1	0.53	64.9	60.8	12.0	-6.6
	2.51	27.9	23.0	0.20	35.1	3.3	0.55	65.8	61.8	12.1	-6.7
	2.55	39.4	23.0	0.20	35.2	3.3	0.55	66.3	62.3	12.3	-6.7
	2.60	55.2	23.0	0.20	35.4	3.4	0.57	66.2	62.4	12.3	-6.8
	2.66	82.0	23.0	0.20	35.5	3.5	0.59	66.4	62.6	12.5	-6.9
	2.70	107.5	23.0	0.20	35.6	3.6	0.60	67.1	63.4	12.6	-6.9
	2.75	137.0	23.0	0.20	35.7	3.7	0.61	67.6	63.9	12.7	-7.0
	2.81	182.7	23.0	0.20	35.8	3.8	0.62	67.9	64.4	12.8	-7.0
	2.85	221.5	23.0	0.20	35.9	3.9	0.63	68.4	64.9	12.9	-7.1
	2.90	263.7	23.0	0.20	36.0	4.0	0.64	68.7	65.2	13.0	-7.1

Note: Unless otherwise specified, input signal is setting modulation with the following condition.

Modulation; $\pi/4$ DPQSK, 18kbps, $\alpha=0.35$, Channel-Band-Width=18KHz, Channel-Spacing=25KHz

RD04HMS2 single-stage amplifier with f=380-470MHz evaluation board

- AN-UHF-114-A-

425MHz	V _{gg}	I _{dq}	P _{in}		P _{out}		I _{dd}	η _D	η _{add}	Gain	I.R.L.
	(V)	(mA)	(dBm)	(W)	(dBm)	(W)	(A)	(%)	(%)	(dB)	(dB)
	2.10	0.3	23.0	0.20	34.2	2.6	0.46	62.2	57.4	11.1	-6.9
	2.15	0.6	23.0	0.20	34.3	2.7	0.47	62.9	58.2	11.3	-6.9
	2.21	1.3	23.0	0.20	34.5	2.8	0.48	63.8	59.2	11.4	-6.9
	2.25	2.2	23.0	0.20	34.6	2.9	0.49	64.1	59.6	11.5	-7.0
	2.30	3.5	23.0	0.20	34.7	2.9	0.50	64.2	59.8	11.6	-7.0
	2.36	6.5	23.0	0.20	34.8	3.0	0.52	64.6	60.3	11.8	-7.0
	2.40	10.4	23.0	0.20	34.9	3.1	0.53	64.7	60.5	11.9	-7.1
	2.45	16.4	23.0	0.20	35.0	3.2	0.53	65.8	61.6	12.0	-7.1
	2.51	28.5	23.0	0.20	35.2	3.3	0.55	66.0	62.0	12.1	-7.1
	2.55	40.2	23.0	0.20	35.2	3.3	0.56	66.3	62.3	12.2	-7.2
	2.60	56.2	23.0	0.20	35.4	3.4	0.57	66.5	62.6	12.3	-7.2
	2.66	83.1	23.0	0.20	35.5	3.5	0.58	66.7	62.9	12.4	-7.3
	2.70	108.8	23.0	0.20	35.5	3.6	0.59	66.9	63.1	12.5	-7.3
	2.75	138.3	23.0	0.20	35.6	3.6	0.60	66.9	63.2	12.6	-7.3
	2.81	184.0	23.0	0.20	35.7	3.7	0.61	67.1	63.5	12.7	-7.4
	2.85	222.7	23.0	0.20	35.8	3.8	0.62	66.9	63.4	12.8	-7.4
	2.90	265.2	23.0	0.20	35.9	3.8	0.63	67.2	63.7	12.9	-7.4

470MHz	V _{gg}	I _{dq}	P _{in}		P _{out}		I _{dd}	η _D	η _{add}	Gain	I.R.L.
	(V)	(mA)	(dBm)	(W)	(dBm)	(W)	(A)	(%)	(%)	(dB)	(dB)
	2.10	0.3	23.0	0.20	34.2	2.7	0.45	64.5	59.6	11.2	-8.0
	2.15	0.5	23.0	0.20	34.3	2.7	0.46	64.4	59.6	11.3	-8.1
	2.21	1.2	23.0	0.20	34.5	2.8	0.47	65.0	60.4	11.4	-8.1
	2.25	2.2	23.0	0.20	34.5	2.8	0.48	65.2	60.6	11.5	-8.2
	2.30	3.4	23.0	0.20	34.6	2.9	0.49	65.3	60.8	11.6	-8.2
	2.36	6.5	23.0	0.20	34.7	3.0	0.50	65.7	61.3	11.7	-8.3
	2.40	10.5	23.0	0.20	34.8	3.0	0.51	65.6	61.3	11.8	-8.3
	2.45	16.5	23.0	0.20	34.9	3.1	0.52	65.5	61.3	11.9	-8.4
	2.51	28.7	23.0	0.20	35.0	3.2	0.53	66.2	62.1	12.0	-8.4
	2.55	40.5	23.0	0.20	35.1	3.2	0.53	66.2	62.1	12.1	-8.5
	2.60	56.5	23.0	0.20	35.1	3.3	0.54	66.1	62.1	12.1	-8.5
	2.66	83.5	23.0	0.20	35.2	3.3	0.55	66.4	62.4	12.2	-8.6
	2.70	109.3	23.0	0.20	35.3	3.4	0.56	66.5	62.5	12.3	-8.7
	2.75	138.9	23.0	0.20	35.3	3.4	0.57	66.3	62.5	12.3	-8.7
	2.81	184.6	23.0	0.20	35.4	3.5	0.58	66.4	62.6	12.4	-8.8
	2.85	223.3	23.0	0.20	35.5	3.5	0.59	66.3	62.6	12.5	-8.8
	2.90	265.9	23.1	0.20	35.5	3.6	0.59	66.5	62.8	12.5	-8.9

Note: Unless otherwise specified, input signal is setting modulation with the following condition.

Modulation; π/4DPQSK, 18kbps, α=0.35, Channel-Band-Width=18KHz, Channel-Spacing=25KHz

5-11. Drain Quiescent Current vs.

OUTPUT POWER and DRAIN EFFICIENCY (Vds=9.1V, Pin=11.5dBm)

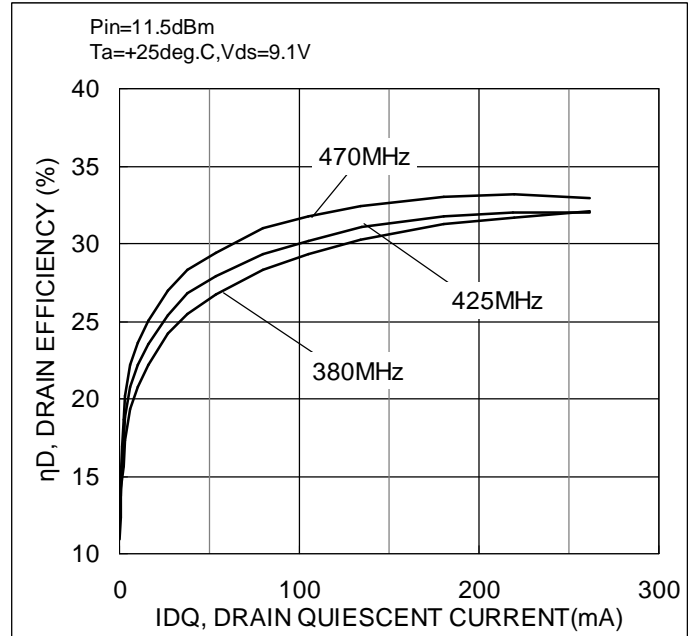
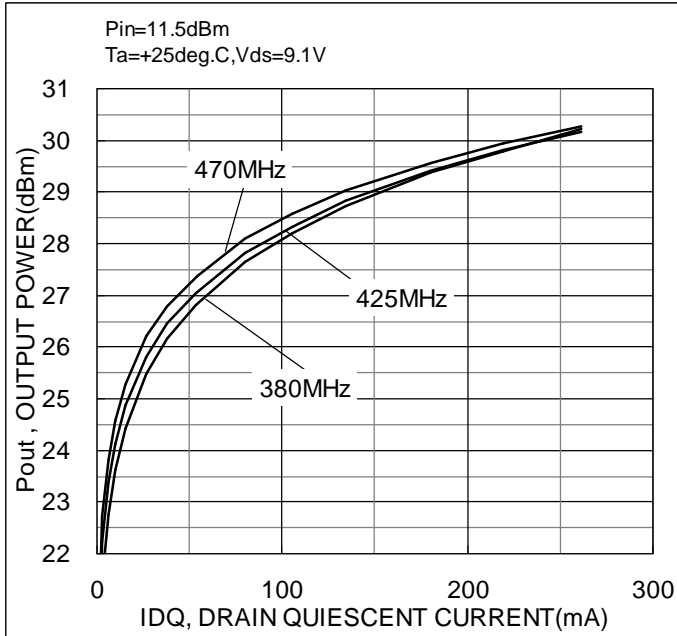

+/- ADJACENT CHANNEL POWER (Vds=9.1V, Pin=11.5dBm)

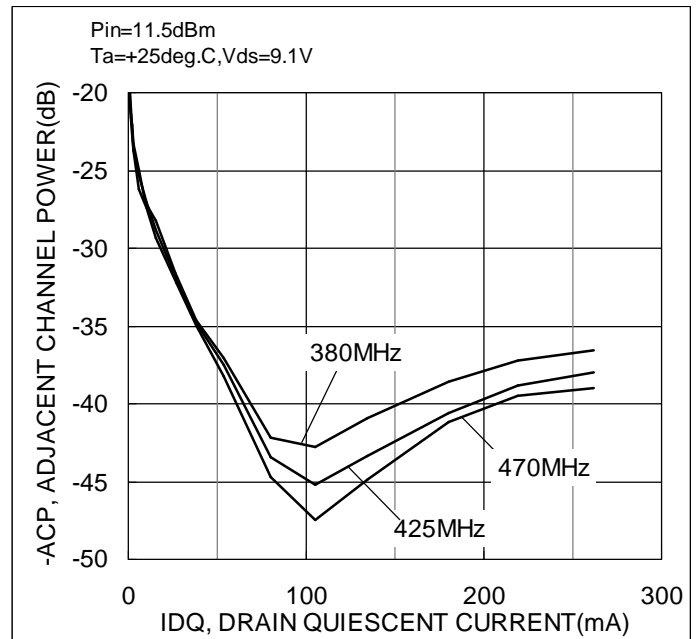
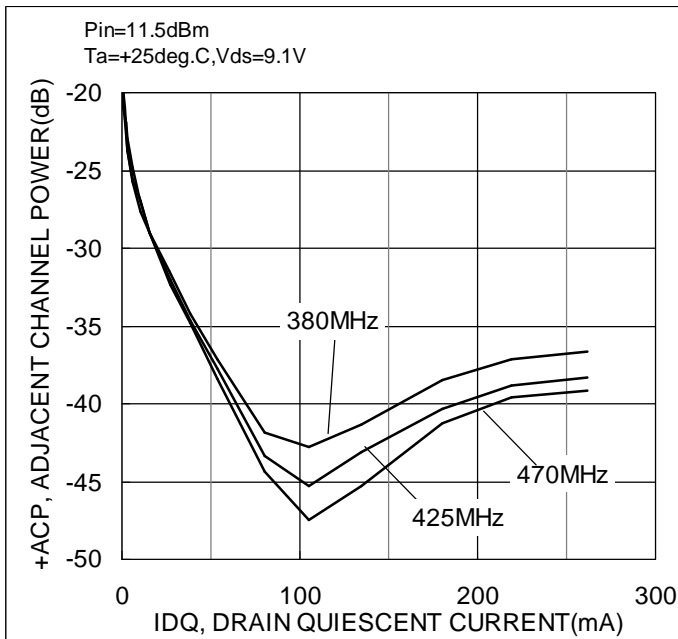

Note: Unless otherwise specified, input signal is setting modulation with the following condition.

Modulation; π/4DPQSK, 18kbps, α=0.35, Channel-Band-Width=18KHz, Channel-Spacing=25KHz

RD04HMS2 single-stage amplifier with f=380-470MHz evaluation board

- AN-UHF-114-A-

Ta=+25deg. C., Vds=9.1V, Pin=11.5dBm

380MHz	Vgg	Idq	Pin		Pout		Idd	η_D	η_{add}	Gain	I.R.L.	-ACP	+ACP
	(V)	(mA)	(dBm)	(W)	(dBm)	(W)	(A)	(%)	(%)	(dB)	(dB)	(dB)	(dB)
	2.10	0.3	11.5	0.014	16.6	0.0	0.05	10.9	7.5	5.1	-4.9	-18.4	-18.4
	2.15	0.5	11.5	0.014	17.9	0.1	0.05	12.3	9.5	6.3	-5.0	-19.2	-19.5
	2.21	1.1	11.5	0.014	19.4	0.1	0.07	14.2	11.9	7.9	-5.1	-21.0	-20.7
	2.25	1.9	11.5	0.014	20.4	0.1	0.08	15.7	13.7	8.9	-5.2	-21.9	-22.1
	2.30	3.1	11.5	0.014	21.5	0.1	0.09	17.3	15.5	10.0	-5.3	-23.0	-23.2
	2.36	6.0	11.5	0.014	22.8	0.2	0.11	19.3	17.9	11.2	-5.5	-24.7	-24.9
	2.40	9.9	11.5	0.014	23.6	0.2	0.12	20.8	19.5	12.1	-5.6	-26.6	-27.1
	2.45	15.6	11.5	0.014	24.4	0.3	0.14	22.2	21.0	12.9	-5.7	-29.0	-28.2
	2.51	26.8	11.5	0.014	25.5	0.4	0.16	24.2	23.2	13.9	-6.0	-31.4	-31.6
	2.55	38.0	11.5	0.014	26.2	0.4	0.18	25.4	24.6	14.6	-6.1	-34.2	-34.6
	2.60	53.6	11.5	0.014	26.8	0.5	0.20	26.8	26.0	15.3	-6.3	-37.1	-37.1
	2.66	79.9	11.5	0.014	27.6	0.6	0.23	28.4	27.7	16.1	-6.6	-41.9	-42.2
	2.70	105.2	11.5	0.014	28.2	0.7	0.25	29.3	28.7	16.7	-6.9	-42.7	-42.7
	2.75	134.4	11.5	0.014	28.7	0.7	0.27	30.2	29.7	17.2	-7.1	-41.4	-41.0
	2.81	180.3	11.5	0.014	29.4	0.9	0.31	31.3	30.8	17.9	-7.5	-38.5	-38.6
	2.85	219.2	11.5	0.014	29.8	1.0	0.33	31.7	31.2	18.3	-7.8	-37.2	-37.3
	2.90	261.6	11.5	0.014	30.2	1.1	0.36	32.1	31.7	18.7	-8.1	-36.6	-36.6

425MHz	Vgg	Idq	Pin		Pout		Idd	η_D	η_{add}	Gain	I.R.L.	-ACP	+ACP
	(V)	(mA)	(dBm)	(W)	(dBm)	(W)	(A)	(%)	(%)	(dB)	(dB)	(dB)	(dB)
	2.10	0.2	11.5	0.014	17.9	0.1	0.05	12.6	9.6	6.3	-5.8	-19.2	-18.7
	2.15	0.5	11.5	0.014	18.9	0.1	0.06	13.8	11.3	7.4	-5.8	-19.9	-19.7
	2.21	1.1	11.5	0.014	20.3	0.1	0.08	15.8	13.7	8.8	-5.9	-20.9	-21.0
	2.25	1.9	11.5	0.014	21.3	0.1	0.09	17.3	15.5	9.8	-6.0	-22.2	-22.3
	2.30	3.1	11.5	0.014	22.2	0.2	0.10	18.8	17.2	10.7	-6.0	-23.7	-23.6
	2.36	6.1	11.5	0.014	23.4	0.2	0.12	20.8	19.4	11.9	-6.2	-25.6	-25.3
	2.40	9.9	11.5	0.014	24.1	0.3	0.13	22.2	21.0	12.6	-6.2	-27.0	-27.0
	2.45	15.7	11.5	0.014	24.9	0.3	0.14	23.5	22.5	13.4	-6.3	-29.0	-28.8
	2.51	26.9	11.5	0.014	25.8	0.4	0.16	25.4	24.4	14.3	-6.5	-32.0	-32.0
	2.55	38.0	11.5	0.014	26.5	0.4	0.18	26.8	25.9	15.0	-6.6	-34.6	-34.8
	2.60	53.7	11.5	0.014	27.1	0.5	0.20	27.9	27.1	15.6	-6.8	-37.7	-37.5
	2.66	79.8	11.5	0.014	27.8	0.6	0.23	29.3	28.6	16.3	-7.0	-43.4	-43.4
	2.70	105.3	11.5	0.014	28.3	0.7	0.25	30.2	29.6	16.8	-7.1	-45.3	-45.2
	2.75	134.4	11.5	0.014	28.8	0.8	0.27	31.1	30.6	17.3	-7.3	-43.1	-43.4
	2.81	180.1	11.5	0.014	29.4	0.9	0.30	31.7	31.2	17.9	-7.5	-40.3	-40.6
	2.85	219.1	11.5	0.014	29.8	1.0	0.33	32.0	31.6	18.3	-7.7	-38.8	-38.8
	2.90	261.5	11.5	0.014	30.2	1.0	0.36	32.0	31.6	18.7	-7.9	-38.3	-38.0

470MHz	Vgg	Idq	Pin		Pout		Idd	η_D	η_{add}	Gain	I.R.L.	-ACP	+ACP
	(V)	(mA)	(dBm)	(W)	(dBm)	(W)	(A)	(%)	(%)	(dB)	(dB)	(dB)	(dB)
	2.10	0.3	11.5	0.014	18.5	0.1	0.06	13.6	10.9	7.0	-6.2	-19.0	-19.1
	2.15	0.5	11.5	0.014	19.6	0.1	0.07	15.0	12.6	8.1	-6.3	-20.5	-19.8
	2.21	1.1	11.5	0.014	20.9	0.1	0.08	16.9	14.9	9.4	-6.4	-21.7	-21.6
	2.25	2.0	11.5	0.014	21.9	0.2	0.09	18.7	17.0	10.4	-6.5	-22.7	-22.7
	2.30	3.1	11.5	0.014	22.7	0.2	0.10	20.2	18.7	11.3	-6.6	-23.7	-23.7
	2.36	6.0	11.5	0.014	23.8	0.2	0.12	22.1	20.9	12.4	-6.8	-25.7	-26.2
	2.40	10.0	11.5	0.014	24.6	0.3	0.13	23.6	22.4	13.1	-6.9	-27.6	-27.4
	2.45	15.7	11.5	0.014	25.3	0.3	0.15	25.1	24.0	13.8	-7.1	-29.0	-29.3
	2.51	26.9	11.5	0.014	26.2	0.4	0.17	27.0	26.1	14.7	-7.3	-32.4	-32.3
	2.55	38.0	11.5	0.014	26.8	0.5	0.19	28.3	27.5	15.3	-7.5	-34.8	-35.0
	2.60	53.7	11.5	0.014	27.4	0.5	0.20	29.4	28.6	15.9	-7.7	-38.4	-38.2
	2.66	79.9	11.5	0.014	28.1	0.6	0.23	31.0	30.3	16.6	-7.9	-44.4	-44.7
	2.70	105.3	11.5	0.014	28.6	0.7	0.25	31.8	31.2	17.1	-8.2	-47.4	-47.5
	2.75	134.4	11.5	0.014	29.0	0.8	0.27	32.5	31.9	17.5	-8.4	-45.3	-44.9
	2.81	180.4	11.5	0.014	29.6	0.9	0.30	33.0	32.5	18.1	-8.7	-41.2	-41.2
	2.85	219.3	11.5	0.014	29.9	1.0	0.33	33.2	32.7	18.4	-9.0	-39.6	-39.5
	2.90	261.7	11.5	0.014	30.3	1.1	0.36	32.9	32.5	18.8	-9.2	-39.1	-39.0

Note: Unless otherwise specified, input signal is setting modulation with the following condition.

Modulation; $\pi/4$ DPQSK, 18kbps, $\alpha=0.35$, Channel-Band-Width=18KHz, Channel-Spacing=25KHz

5-12. Input Power vs.

OUTPUT POWER and - ADJACENT CHANNEL POWER

(Vds=9.1V, Each Drain Quiescent Current IDQ=50/75/100/125mA)

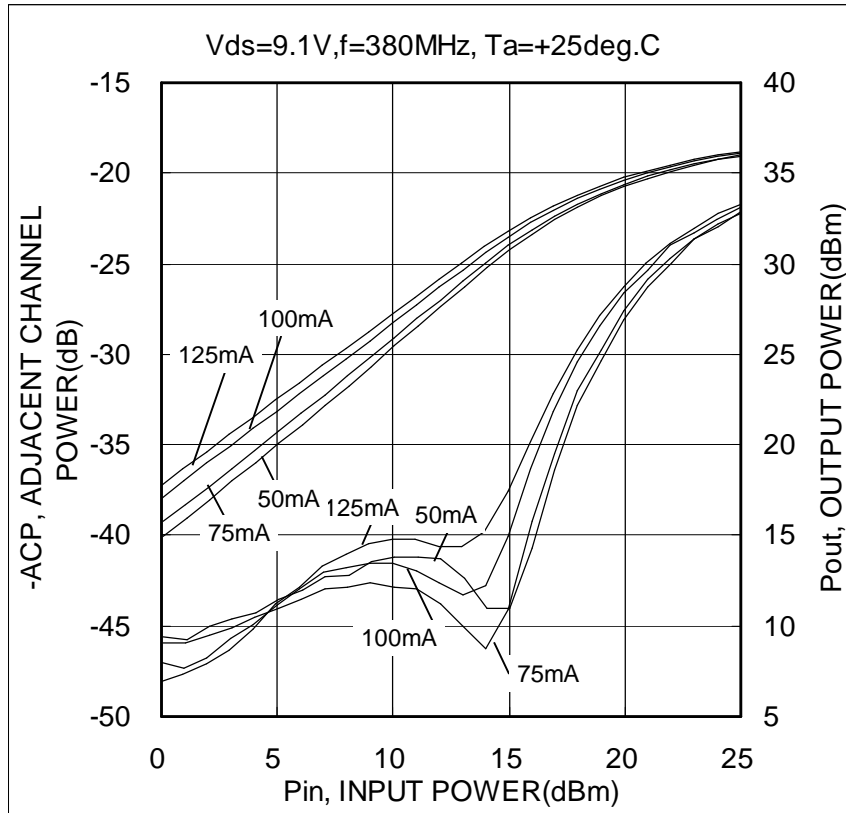

Vds=9.1V, f=380MHz

Idq=50mA				Idq=75mA				Idq=100mA				Idq=125mA							
Pin (dBm)	Pout (W)	-ACP (dB)	-ACP (dB)	Pin (dBm)	Pout (W)	-ACP (dB)	-ACP (dB)	Pin (dBm)	Pout (W)	-ACP (dB)	-ACP (dB)	Pin (dBm)	Pout (W)	-ACP (dB)	-ACP (dB)				
0.1	0.00	15.0	0.03	-45.6	0.0	0.00	15.7	0.04	-46.0	0.0	0.00	17.0	0.05	-47.0	-0.1	0.00	17.7	0.06	-48.1
1.1	0.00	16.0	0.04	-45.8	1.0	0.00	16.7	0.05	-46.0	1.0	0.00	18.0	0.06	-47.4	0.9	0.00	18.7	0.07	-47.6
2.1	0.00	17.0	0.05	-45.0	2.0	0.00	17.7	0.06	-45.5	2.0	0.00	19.0	0.08	-46.8	1.9	0.00	19.6	0.09	-47.1
3.1	0.00	18.0	0.06	-44.6	3.0	0.00	18.7	0.07	-45.1	3.0	0.00	19.9	0.10	-45.7	2.9	0.00	20.6	0.11	-46.4
4.1	0.00	19.0	0.08	-44.3	4.0	0.00	19.7	0.09	-44.6	4.0	0.00	20.9	0.12	-45.0	3.9	0.00	21.5	0.14	-45.2
5.1	0.00	20.1	0.10	-43.6	5.0	0.00	20.7	0.12	-44.1	5.0	0.00	21.9	0.15	-43.9	4.9	0.00	22.5	0.18	-43.7
6.1	0.00	21.1	0.13	-43.0	6.0	0.00	21.7	0.15	-43.6	6.0	0.00	22.8	0.19	-43.0	5.9	0.00	23.4	0.22	-42.9
7.1	0.01	22.2	0.17	-42.3	7.0	0.01	22.8	0.19	-43.0	7.0	0.00	23.8	0.24	-42.0	6.9	0.00	24.4	0.27	-41.7
8.1	0.01	23.3	0.21	-42.2	8.0	0.01	23.8	0.24	-42.9	8.0	0.01	24.8	0.30	-41.8	7.9	0.01	25.3	0.34	-41.0
9.1	0.01	24.4	0.27	-41.5	9.0	0.01	24.8	0.31	-42.6	9.0	0.01	25.8	0.38	-41.5	9.0	0.01	26.3	0.42	-40.5
10.1	0.01	25.4	0.35	-41.2	10.0	0.01	25.9	0.39	-42.9	10.0	0.01	26.7	0.47	-41.6	10.0	0.01	27.2	0.53	-40.3
11.1	0.01	26.5	0.45	-41.2	11.0	0.01	27.0	0.50	-43.0	11.0	0.01	27.7	0.59	-41.9	11.0	0.01	28.2	0.66	-40.2
12.1	0.02	27.7	0.58	-41.3	12.0	0.02	28.0	0.63	-43.8	12.0	0.02	28.7	0.74	-42.6	12.0	0.02	29.1	0.82	-40.6
13.1	0.02	28.7	0.75	-42.4	13.0	0.02	29.1	0.81	-45.0	13.0	0.02	29.7	0.92	-43.3	13.0	0.02	30.0	1.01	-40.6
14.0	0.03	29.8	0.95	-44.0	14.0	0.03	30.1	1.01	-46.2	14.0	0.02	30.6	1.15	-42.8	13.9	0.02	30.9	1.24	-39.8
15.0	0.03	30.8	1.19	-44.0	15.0	0.03	31.0	1.26	-44.1	15.0	0.03	31.5	1.40	-40.1	14.9	0.03	31.8	1.50	-37.5
16.0	0.04	31.6	1.46	-40.7	16.0	0.04	31.8	1.53	-39.2	15.9	0.04	32.3	1.68	-36.3	15.9	0.04	32.5	1.78	-34.9
17.0	0.05	32.4	1.75	-36.4	17.0	0.05	32.6	1.82	-35.5	16.9	0.05	33.0	1.98	-33.2	16.9	0.05	33.2	2.08	-32.1
18.0	0.06	33.1	2.06	-32.8	18.0	0.06	33.3	2.14	-32.0	17.9	0.06	33.6	2.29	-30.5	17.9	0.06	33.8	2.40	-29.8
19.0	0.08	33.8	2.38	-30.3	19.0	0.08	33.9	2.45	-29.7	18.9	0.08	34.1	2.60	-28.5	18.9	0.08	34.3	2.70	-27.8
20.0	0.10	34.3	2.68	-28.1	20.0	0.10	34.4	2.75	-27.6	20.0	0.10	34.6	2.89	-26.6	19.9	0.10	34.8	2.99	-26.3
21.0	0.13	34.7	2.97	-26.3	21.0	0.13	34.8	3.04	-25.8	21.0	0.12	35.0	3.17	-25.4	20.9	0.12	35.1	3.27	-25.0
22.0	0.16	35.1	3.25	-25.0	22.0	0.16	35.2	3.32	-24.7	22.0	0.16	35.4	3.43	-24.0	22.0	0.16	35.5	3.52	-23.9
23.0	0.20	35.5	3.51	-23.6	23.0	0.20	35.5	3.56	-23.6	23.0	0.20	35.7	3.67	-23.3	23.0	0.20	35.7	3.75	-23.1
24.0	0.25	35.7	3.74	-23.0	24.0	0.25	35.8	3.79	-22.8	24.0	0.25	35.9	3.89	-22.5	24.0	0.25	36.0	3.96	-22.3
25.0	0.32	36.0	3.95	-22.1	25.0	0.32	36.0	4.00	-22.2	25.0	0.32	36.1	4.09	-21.9	25.0	0.32	36.2	4.16	-21.7

Note: Unless otherwise specified, input signal is setting modulation with the following condition.

Modulation; π/4DPSK, 18kbps, α=0.35, Channel-Band-Width=18KHz, Channel-Spacing=25KHz